

# Enabling Switches

## Grip Style Enabling Switches



# What is an enabling switch?

Because operators use teach pendants in hazardous environments performing teaching, system changeover, and maintenance of robots, they must have protection against unpredictable motion of robots, and therefore teach pendants are equipped with 3-position enabling switches.

An enabling switch is a 3-position (OFF-ON-OFF) switch to allow a machine operation only when the

switch is lightly pressed and held in the mid position (position 2). Because it disables machine operation when released (position 1) or further depressed (position 3) by a panicked operator, the safety of operators using teach pendants or grip style enabling switches in hazardous environments is ensured.

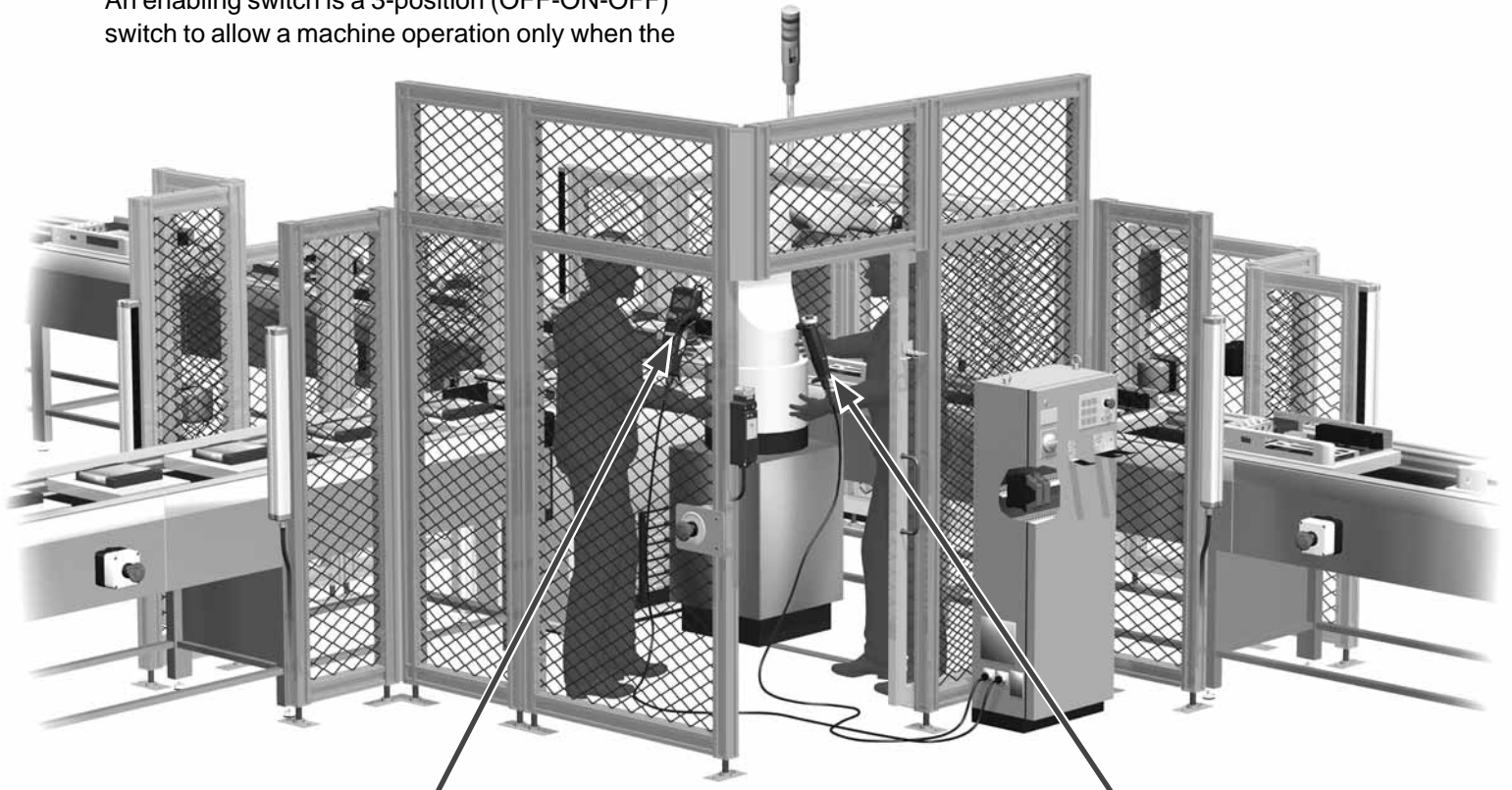

**HG2S CC Pendant**

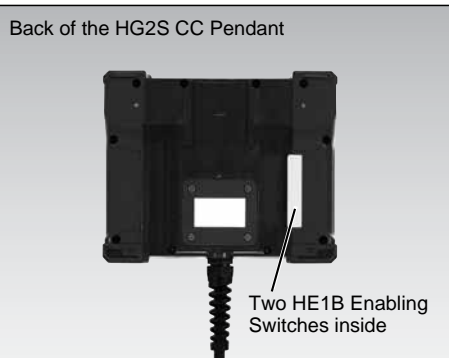

**HE1G/HE1G-L/HE2G Grip Style**

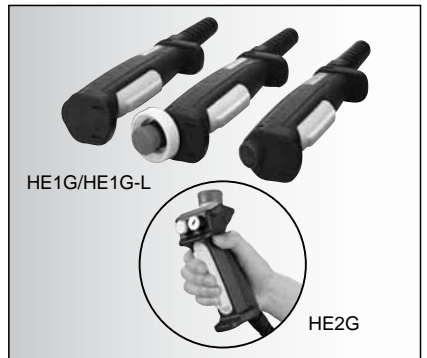

**HG1H/1T Small Teaching Pendant**



**HE9Z-GSH51 Grip Style Enabling Switch Housing + HE5B Enabling Switch**

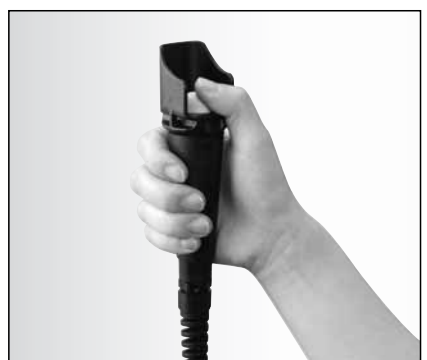

## Operation of enabling switches

The requirement for operation of 3-position enabling switches (according to IEC 60204-1; 9.2.5.8):

When an enabling device is provided as a part of a system, it shall be designed to allow motion when actuated in one position only. In any other position motion shall be stopped.

– for a three-position type:

- position 1: off-function of the switch (actuator is not operated)
- position 2: enabling function (actuator is operated in its mid position)
- position 3: off-function (actuator is operated past its mid position)

When returning from position 3 to position 2, the function shall be ended.

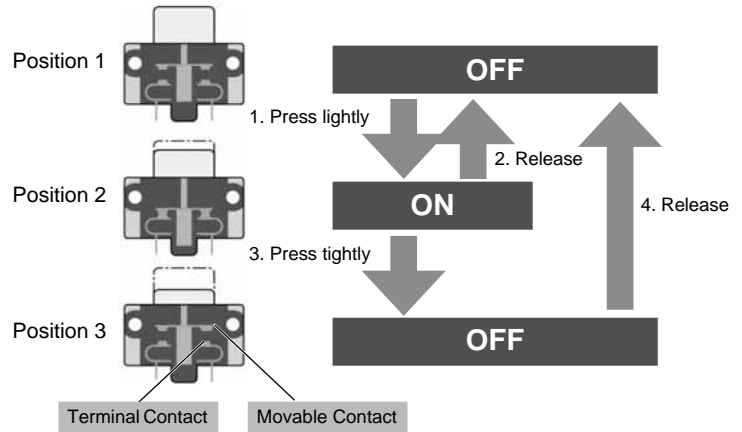

## Disparity detection of two contacts

- A high level of safety—safety category 3 or higher (ISO 13849-1)—is required when an operator works near a hazard inside a safety guard.

When released to position 1, the contacts are opened (turned off) by the force of a released spring. The 3-position enabling switches must be prepared for failures such as contact welding and short-circuits, and a dual circuit is provided. Even if one contact fails, the remaining contact can disable machine operation. Furthermore, a disparity detection circuit is provided so that machine operation is disabled when a disparity between the two circuits is detected using a safety relay module.

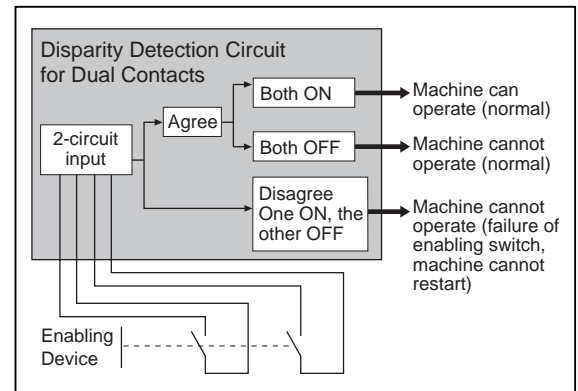

## International standards on enabling switches

### IEC 60204-1: 1997

**9.2.4** Where it is necessary to suspend safeguarding, (e.g. for setting or maintenance purposes), a mode selection device or means capable of being secured (e.g. locked) in the desired mode shall be provided so as to prevent automatic operation. In addition, one or more of the following means shall be provided:

- a portable control station (e.g. pendant) with an emergency stop device and, where appropriate, an enabling device. Where a portable station is in use, motion may be initiated only from that station.

### ISO 12100-2: 2003 Control mode for setting, teaching, process changeover, fault-finding, cleaning or maintenance

**4.11.9** Where, for setting, teaching, process changeover, fault-finding, cleaning or maintenance of machinery, a guard has to be displaced or removed and/or a protective device has to be disabled, and where it is necessary for the purpose of these operations for the machinery or part of the machinery to be put in operation, safety of the operator shall be achieved using a specific control mode which simultaneously:

- permits operation of the hazardous elements only by continuous actuation of an enabling device, a hold-to-run control device or a two-hand control device.

### ANSI/RIA R15.06

The pendant or teaching control device shall have an enabling device using a three position switch which, when continuously held in a detented position, permits motion. Release of or compression past the midpoint detent of the device shall stop robot motion using circuitry consistent with 4.5.

Note: Tests have shown that human reaction to an emergency may be to release an object, or hold on tighter, thus compressing an enabling device. Design and installation of the enabling device should consider the ergonomics issues of sustained activation.

### ANSI B11.19, 12.3.1.3

Enabling devices shall be designed and constructed to permit limited and supervised machine motion while personnel are inside a hazard area.

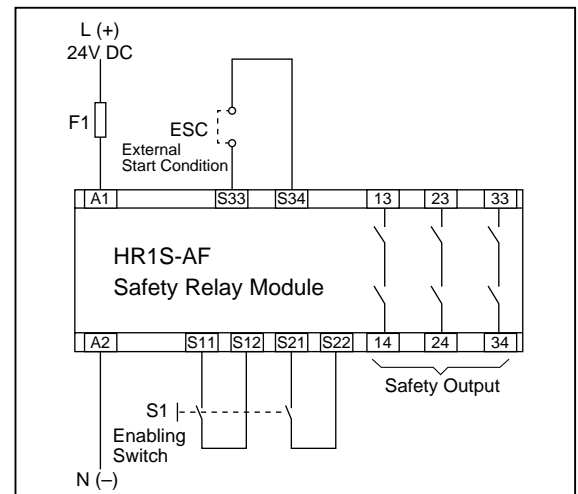



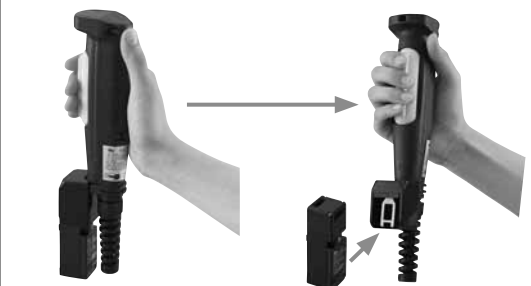



### A method of changing an operation mode (auto/manual) using the HS5B interlock switch and grip style enabling switch (HE1G)



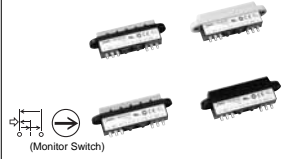

Enabling switch is attached to the interlock switch—machine operates automatically.

Enabling switch is detached from the interlock switch—machine can be operated only manually.

# Enabling Switch and Grip Style Enabling Switch Selection Guide

Enabling Switch				
Model	<b>HE1B</b> Side Mounting Top Mounting (w/o rubber boot)	<b>HE2B</b> Rectangular (w/ and w/o rubber boot)	<b>HE3B</b> ø16mm Round Hole (w/ and w/o rubber boot)	<b>HE5B</b> ø16mm Round Hole (w/ rubber boot)
Shape				
Safety Category	4	4	4	4
Applicable Standards	UL508 (UL recognized) CSA C22. No. 14 (c-UL recognized) IEC / EN 60947-5-1 (TÜV approval) IEC / EN 60947-5-8 (TÜV approval)			
Standards				
Page	7	9	12	14

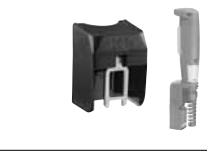
Enabling Switch		Grip Style Three-position Enabling Switch		
Model	<b>HE6B</b> Rectangular (w/ rubber boot)	<b>HE1G</b> Size: standard Operation force: standard	<b>HE1G-L</b> Size: standard Operation force: light	<b>HE2G</b> Size: small Operation force: light
Shape				
Safety Category	4	4	4	4
Applicable Standards	UL508 (UL recognized) CSA C22. No. 14 (c-UL recognized) IEC / EN 60947-5-1 IEC / EN 60947-5-8 (TÜV approval) GS-ET-22 (TÜV approval)	UL508 (UL listed) CSA C22. No. 14 (c-UL listed) IEC / EN 60947-5-1 (TÜV/BG approval) GS-ET-22 (TÜV/BG approval)	UL508 (UL listed) CSA C22. No. 14 (c-UL listed) IEC / EN 60947-5-1 (TÜV/BG approval) GS-ET-22 (TÜV/BG approval)	UL508 (approval pending) CSA C22.2 No.14 (approval pending) IEC / EN60947-5-1 (TÜV approval) GS-ET-22 (TÜV approval)
Standards				
Page	17	19	22	24













































































Grip Style Three-position Enabling Switch		Actuator with Plastic Holder
Model	<b>HE9Z-GSH51 + HE5B</b> Housing (Note)	<b>HE9Z-GP15</b> Actuator holder for grip-style three-position enabling switch
Shape		
Safety Category	4	—
Applicable Standards	UL50 CSA C22.2 No.14 EN60529	—
Standards		—
Page	16	30

Note: HE9Z-GSH51 is housing only. Install the HE5B enabling switch to use as a grip style enabling switch. See page 16 for details.



# Enabling Switch and Grip Style Enabling Switch Selection Chart

## Enabling Switch Selection Chart According to ISO/IEC Standards

			Model	Standards	Marks	Page
<p>ISO 12100-2: 2003 Control mode for setting, teaching, process changeover, fault-finding, cleaning or maintenance 4.11.9 permits operation of the hazardous elements only by continuous actuation of an enabling device, a hold-to-run control device or a two-hand control device;</p>	<p>For Installation in Equipment</p>	<p>3-position Switch with 1 Contact (2 switches are used for duplication)</p>	<p>Panel Top Installation</p> <p>IP40</p> 	IEC/EN60947-5-8 UL508 CSA C22.2 No.14	     	7
			<p>Panel Side Installation</p> <p>IP40</p> 	IEC/EN60947-5-8 UL508 CSA C22.2 No.14	     	
<p>IEC 60204-1: 1997 9.2.5.8 When an enabling device is provided as a part of a system, it shall be designed to allow motion when actuated in one position only. In any other position motion shall be stopped.</p>	<p>For Direct Operation with Hand</p>	<p>3-position Switch with 2 Contacts</p>	<p>Installed in Rectangular Panel Cut-out (4-finger operation)</p> <p>w/o Monitor Switch for Position Detection</p> <p>IP40</p> 	IEC/EN60947-5-8 UL508 CSA C22.2 No.14	     	9
			<p>Installed in Rectangular Panel Cut-out (4-finger operation)</p> <p>w/ Monitor Switch for Position Detection</p> <p>IP65</p> 	IEC/EN60947-5-8 UL508 CSA C22.2 No.14	     	
<p>ANSI/ RIA R15.06 4.7.3 Enabling device The pendant or teaching control device shall have an enabling device using a three position switch, which continuously held in a detented position, permits motion.</p>	<p>For Direct Operation with Hand</p>	<p>3-position Switch with 2 Contacts</p>	<p>Installed in Rectangular Panel Cut-out (4-finger operation)</p> <p>w/ Monitor Switch for Position Detection</p> <p>IP40</p> 	IEC/EN60947-5-8 UL508 CSA C22.2 No.14	      <p>(Monitor Switch)</p>	9
			<p>Installed in Rectangular Panel Cut-out (4-finger operation)</p> <p>w/ Monitor Switch for Position Detection</p> <p>IP65</p> 	IEC/EN60947-5-8 UL508 CSA C22.2 No.14	      <p>(Monitor Switch)</p>	
<p>ANSI B11.19 12.3.1.1 Enabling devices shall be designed and constructed to permit limited and supervised machine motion while personnel are inside a hazard area.</p>	<p>For Direct Operation with Hand</p>	<p>3-position Switch with 2 Contacts</p>	<p>Installed in Rectangular Panel Cut-out (1- or 2-finger operation)</p> <p>w/o Monitor Switch for Position Detection</p> <p>IP65</p> 	IEC/EN60947-5-8 UL508 CSA C22.2 No.14	     	17
			<p>Installed in Rectangular Panel Cut-out (1- or 2-finger operation)</p> <p>w/ Monitor Switch for Position Detection</p> <p>IP65</p> 	IEC/EN60947-5-8 UL508 CSA C22.2 No.14	      <p>(Monitor Switch)</p>	
<p>SEMI S2-0703 20.4 Industrial robots and industrial robot systems should meet the requirements of appropriate national or international standards, e.g., ANSI/RIA R15.06, ISO standards 10218, EN 775.</p>	<p>For Direct Operation with Hand</p>	<p>3-position Switch with 2 Contacts</p>	<p>Installed in ø16mm Round Hole (thumb or 3-finger operation)</p> <p>IP40</p> 	IEC/EN60947-5-8 UL508 CSA C22.2 No.14	     	12
			<p>Installed in ø16mm Round Hole (thumb or 3-finger operation)</p> <p>IP65</p> 	IEC/EN60947-5-8 UL508 CSA C22.2 No.14	     	
			<p>Installed in ø16mm Round Hole (thumb operation)</p> <p>IP65</p> 	IEC/EN60947-5-8 UL508 CSA C22.2 No.14	     	

# Enabling Switch and Grip Style Enabling Switch Selection Chart

## Enabling Switch Selection Chart According to ISO/IEC Standards

ISO 12100-2: 2003  
Control mode for setting, teaching, process changeover, fault-finding, cleaning or maintenance 4.11.9 permits operation of the hazardous elements only by continuous actuation of an enabling device, a hold-to-run control device or a two-hand control device;

IEC 60204-1: 1997 9.2.5.8  
When an enabling device is provided as a part of a system, it shall be designed to allow motion when actuated in one position only. In any other position motion shall be stopped.

ANSI/ RIA R15.06 4.7.3 Enabling device  
The pendant or teaching control device shall have an enabling device using a three position switch, which continuously held in a detented position, permits motion.

ANSI B11.19 12.3.1.1 Enabling devices shall be designed and constructed to permit limited and supervised machine motion while personnel are inside a hazard area.

SEMI S2-0703 20.4 Industrial robots and industrial robot systems should meet the requirements of appropriate national or international standards, e.g., ANSI/RIA R15.06, ISO standards 10218, EN 775.

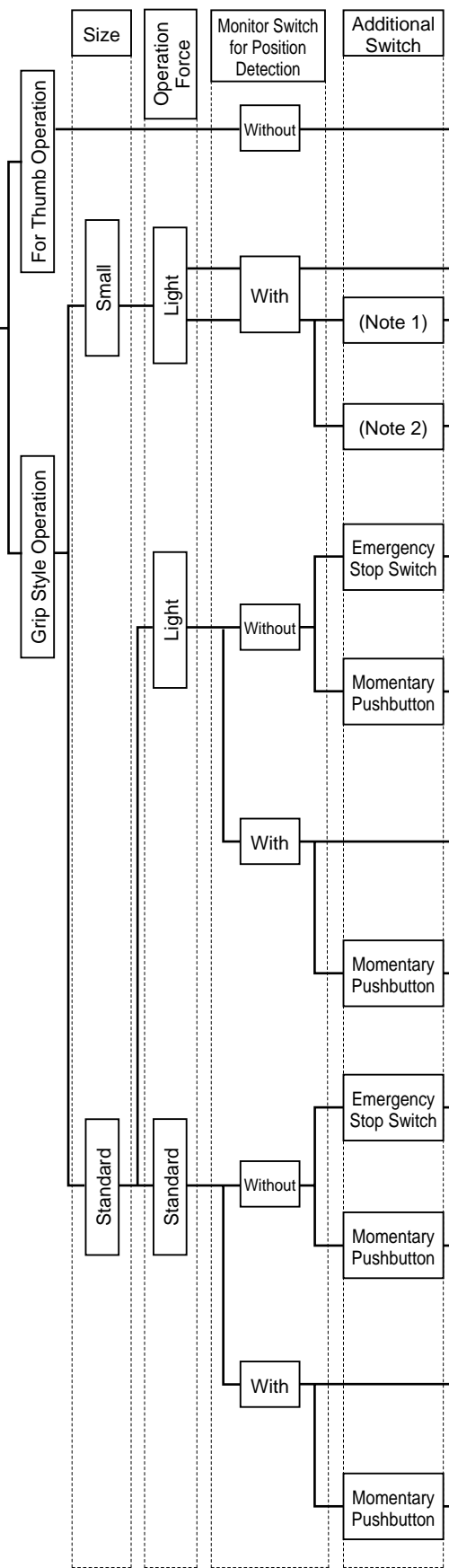

Model	Standards	Marks	Page
 HE9Z-GSH51 +HE5B-2P*	(HE9Z-GSH51) EN60529 UL50		16
	(HE5B-M2P*) IEC/EN60947-5-8 UL508 CSA C22.2 No.14		
 HE2G-21S*	EN60947-5-1 UL508 CSA C22.2 No.14 GS-ET-22	 (Monitor Switch) UL approval pending	24
 HE2G-21S*E	EN60947-5-1 UL508 CSA C22.2 No.14 GS-ET-22	 (Monitor Switch) UL approval pending	
 HE1G-L20ME	EN60947-5-1 UL508 CSA C22.2 No.14 GS-ET-22	 (screw terminal) CE	22
 HE1G-L20MB	EN60947-5-1 UL508 CSA C22.2 No.14 GS-ET-22	 (screw terminal) CE	
 HE1G-L21SM	EN60947-5-1 UL508 CSA C22.2 No.14 GS-ET-22	 (screw terminal) CE (Monitor Switch)	
 HE1G-L21SMB	EN60947-5-1 UL508 CSA C22.2 No.14 GS-ET-22	 (screw terminal) CE (Monitor Switch)	
 HE1G-20ME	EN60947-5-1 UL508 CSA C22.2 No.14 GS-ET-22	 CE	
 HE1G-20MB	EN60947-5-1 UL508 CSA C22.2 No.14 GS-ET-22	 CE	
 HE1G-21SM	EN60947-5-1 UL508 CSA C22.2 No.14 GS-ET-22	 CE (Monitor Switch)	19
 HE1G-21SMB	EN60947-5-1 UL508 CSA C22.2 No.14 GS-ET-22	 CE (Monitor Switch)	

Note 1: With momentary pushbutton or key selector switch

Note 2: With emergency stop switch and momentary pushbutton or key selector switch

# HE1B Basic Three-position Enabling Switches

## 3-position enabling switch to avoid hazards.

### Ideal for installing in teach pendants and other enabling devices.

- Ergonomically-designed OFF-ON-OFF.
- Direct opening action mechanism for shifting from position 2 (ON) to position 3 (OFF) (EN 60947-5-1/IEC 60947-5-1, Annex K).
- The switch does not turn ON while being released from position 3 (OFF when pressed) to position 1 (OFF when released) (IEC60204-1, 9.2.5.8).
- Reliable performance in compact and lightweight package.



## HE1B

Mounting Style	Contact Configuration	Part No.	Ordering No.	Package Quantity
Side Mounting	1 contact (3-position)	HE1B-M1	HE1B-M1PN10	10
Top Mounting		HE1B-M1N	HE1B-M1NPN10	

- Minimum applicable load (reference value): 3V AC/DC, 5 mA

## Ratings

### Contact Ratings

Rated Insulation Voltage (Ui)		250V			
Rated Thermal Current (Ith)		5A			
Rated Voltage (Ue)		30V	125V	250V	
Rated Current (Ie)	AC 50/60 Hz	Resistive Load (AC-12)	—	3A	1.5A
		Inductive Load (AC-15)	—	1.5A	0.75A
	DC	Resistive Load (DC-12)	2A	0.4A	0.2A
		Inductive Load (DC-13)	1A	0.22A	0.1A
Contact Configuration (3-position switch)		1 contact			

- Minimum applicable load (reference value): 3V AC/DC, 5 mA  
(Applicable range is subject to the operating conditions and load.)

## Specifications

Applicable Standards	UL508 (UL recognized), CSA C22.2, No. 14 (c-UL recognized), IEC/EN 60947-5-1, IEC/EN 60947-5-8 (TÜV approval)
Applicable Standards for Use	ISO 12100-1, -2/EN12100-1, -2, IEC 60204-1 / EN 60204-1 ISO 11161 / prEN 11161, ISO 10218 / EN 775, ANSI/RIA R15.06, ANSI B11.19
Operating Temperature	-25 to +60°C (no freezing)
Relative Humidity	45 to 85% (no condensation)
Storage Temperature	-40 to +80°C (no freezing)
Pollution Degree	2
Contact Resistance	50 mΩ maximum (initial value)
Insulation Resistance	100 MΩ minimum (500V DC megger)
Impulse Withstand Voltage	2.5 kV
Operating Frequency	1,200 operations per hour
Mechanical Durability	Position 1 → 2 → 1: 1,000,000 operations Position 1 → 2 → 3 → 1: 100,000 operations
Electrical Durability	100,000 operations minimum
Shock Resistance	Operating extremes: 150 m/s <sup>2</sup> Damage limits: 1,000 m/s <sup>2</sup>
Vibration Resistance	Operating extremes: 5 to 55 Hz, amplitude 0.5 mm Damage limits: 16.7 Hz, amplitude 1.5 mm
Terminal Style	Solder terminal
Applicable Wire	1 cable, 0.5 mm <sup>2</sup> maximum
Terminal Soldering Heat Resistance	310 to 350°C, 3 seconds maximum
Terminal Tensile Strength	20N minimum
Mounting Screw Recommended Tightening Torque	HE1B-M1: M3 screw / 0.5 to 0.8 N·m HE1B-M1N: M2.6 screw / 0.4 to 0.6 N·m
Degree of Protection	IP40, except terminals (IEC 60529)
Conditional Short-circuit Current	50A (250V) (Use 250V/10A fast-blow fuse for short-circuit protection.)
Direct Opening Force	30N minimum (position 2 → 3)
Operator Strength	250N minimum
Weight (approx.)	6g

# HE1B Basic Three-position Enabling Switches

## Operation Characteristics

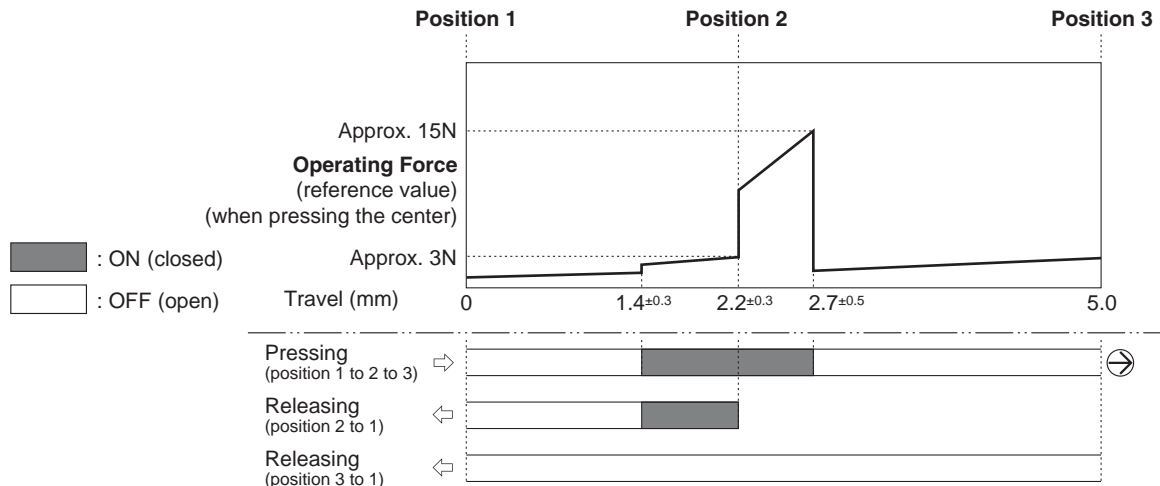

## Dimensions

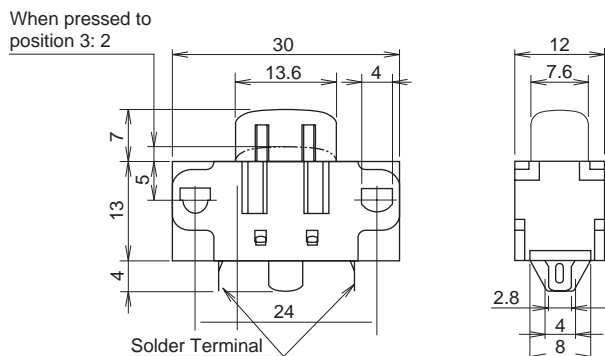

## Mounting Hole Layout

### HE1B-M1 (side mounting)

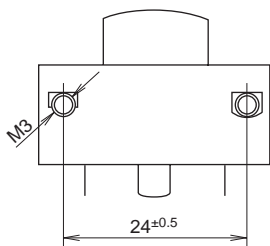

- Two M3 nuts are supplied. M3 mounting screws must be supplied by the user.

### HE1B-M1N (top mounting)

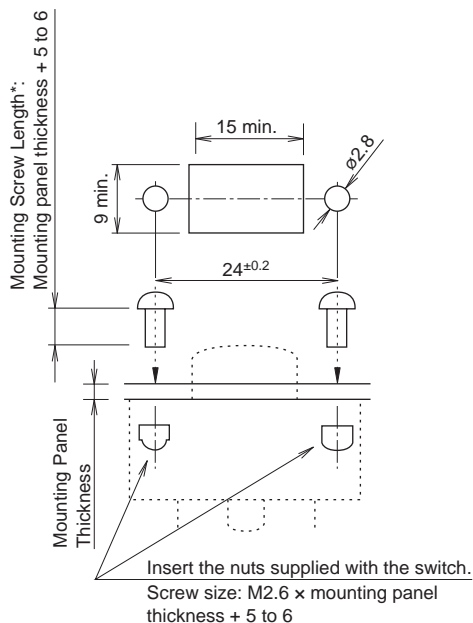

Note: When installed on a mounting panel thicker than 2 mm, the actuator surface is below the panel when the button is pressed to position 3.

- \* Two M2.6 nuts are supplied. Mounting screws (M2.6) must be supplied by the user.

All dimensions in mm.



# HE2B Double Three-position Enabling Switches

## Multi-contact 3-position enabling switches Ideal for installing in large teach pendants

- Ergonomically-designed OFF-ON-OFF operation.
- Easy recognition of position 1 to 2 transition is made possible by a snap action switch.
- Sufficient difference in operating force is provided for shifting from position 2 to 3.
- Low pressure is required to maintain position 2, allowing for longtime operation.
- Reliable operation is assured even when the edge of the operator button is pressed.
- The switch does not turn ON while being released from position 3 (OFF) to position 1 (OFF) (IEC60204-1, 9.2.5.8).
- Some teach pendants are equipped with two 3-position enabling switches, and when one switch is pressed to position 3 (OFF), the other switch must not enable machine operation even when pressed to position 2. Enabling of machine operation must resume after both switches are released. For this purpose, also available are 3-position enabling switches with monitoring switches for button returned to position 1 and button pressed to position 3 (monitor switches have direct opening action mechanism).
- Two contacts are provided in a 3-position enabling switch so that even if one contact fails due to welding or short-circuit, the other contact can disable machine operation.
- The waterproof rubber boot provides IP65 protection.

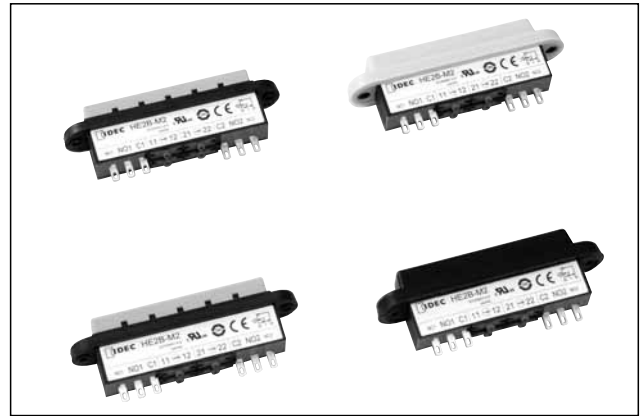

## HE2B

Style		Contact Configuration			Part No.	Ordering No.	Package Quantity
		3-position Switch	Return Monitor Switch	Depress Monitor Switch			
Without Rubber Boot		2	0	0	HE2B-M200	HE2B-M200 HE2B-M200PN10	1 10
		2	1	1	HE2B-M211	HE2B-M211 HE2B-M211PN10	1 10
		2	2	2	HE2B-M222	HE2B-M222 HE2B-M222PN10	1 10
With Rubber Boot	Rubber Boot Material: Silicon Rubber Color: B: black Y: yellow	2	0	0	HE2B-M200P*	HE2B-M200P* HE2B-M200P*PN10	1 10
		2	1	1	HE2B-M211P*	HE2B-M211P* HE2B-M211P*PN10	1 10
		2	2	2	HE2B-M222P*	HE2B-M222P* HE2B-M222P*PN10	1 10
	Rubber Boot Material: NBR/PVC Polyblend Color: gray	2	0	0	HE2B-M200PN1	HE2B-M200PN1 HE2B-M200PN1PN10	1 10
		2	1	1	HE2B-M211PN1	HE2B-M211PN1 HE2B-M211PN1PN10	1 10
		2	2	2	HE2B-M222PN1	HE2B-M222PN1 HE2B-M222PN1PN10	1 10

Note: Specify a rubber boot color code in place of \* in the Ordering No.

## Part No. Development

		<b>HE2B - M 2 0 0 P *</b>			
• 3-position Switch	2: 2 contacts	• Button Return Monitor Switch	0: Without switch 1: 1 contact 2: 2 contacts	• Rubber Boot Material, Color	Blank: Without rubber boot Y: Silicon rubber, yellow B: Silicon rubber, black N1: NBR/PVC polyblend, gray
• Button Depress Monitor Switch	0: Without switch 1: 1 contact 2: 2 contacts	• Rubber Boot	Blank: Without rubber boot P: With rubber boot		

## Ratings

### Contact Ratings

Rated Insulation Voltage (Ui)		250V				
Rated Thermal Current (Ith)		3A				
Rated Voltage (Ue)		30V	125V	250V		
Rated Current (Ie)	3-position Switch	AC	Resistive Load (AC-12)	—	1A	0.5A
		DC	Resistive Load (DC-12)	1A	0.2A	—
	Button Return Monitor Switch Button Depress Monitor Switch	AC	Resistive Load (AC-12)	—	2A	1A
		DC	Resistive Load (DC-12)	2A	0.4A	0.2A
		AC	Inductive Load (AC-15)	—	1A	0.5A
		DC	Inductive Load (DC-13)	0.7A	0.1A	—
Contact Configuration		3-position Switch	2 contacts			
		Return Monitor Switch	0 to 2 contacts			
		Depress Monitor Switch	0 to 2 contacts			

- Minimum applicable load (reference value): 3V AC/DC, 5 mA (monitor switch), 5V AC/DC, 1 mA (3-position switch) (Applicable range is subject to the operation conditions and load.)

# HE2B Double Three-position Enabling Switches

## Specifications

Applicable Standards	UL508 (UL recognized), CSA C22.2, No. 14 (c-UL recognized), IEC/EN 60947-5-1, IEC/EN 60947-5-8 (TÜV approval)
Applicable Standards for Use	ISO 12100-1, -2, EN 12100-1, 2 / EN 292, IEC 60204-1 / EN 60204-1 ISO11161 / prEN 11161, ISO10218 / EN 775, ANSI / RIA R15.06, ANSI B11.19
Operating Temperature	-25 to +60°C (no freezing) (without rubber boot, with silicon rubber boot) -10 to +60°C (no freezing) (with NBR/PVC polyblend rubber boot)
Relative Humidity	45 to 85% RH (no condensation)
Storage Temperature	-40 to +80°C (no freezing)
Pollution Degree	2 (inside panel, terminal side) 3 (outside panel, operator side)
Contact Resistance	50 mΩ maximum (initial value)
Insulation Resistance	Between live and dead metal parts: 100 MΩ minimum (500V DC megger) Between terminals of different poles: 100 MΩ minimum (500V DC megger)
Impulse Withstand Voltage	2.5 kV
Operating Frequency	1,200 operations per hour
Mechanical Durability	Position 1 → 2 → 1: 1,000,000 operations minimum Position 1 → 2 → 3 → 1: 100,000 operations minimum
Electrical Durability	100,000 operations minimum
Shock Resistance	Operating extremes: 150 m/s <sup>2</sup> Damage limits: 1,000 m/s <sup>2</sup>
Vibration Resistance	Operating extremes: 5 to 55 Hz, amplitude 0.5 mm Damage limits: 16.7 Hz, amplitude 1.5 mm
Terminal Style	Solder terminal
Applicable Wire	1 cable, 0.5 mm <sup>2</sup> maximum
Terminal Soldering Heat Resistance	310 to 350 °C, 3 seconds maximum
Terminal Tensile Strength	20N minimum
Mounting Screw Recommended Tightening Torque	0.5 to 0.8 N·m
Degree of Protection	IP40 (without rubber boot) IP65 (with rubber boot) (IEC 60529)
Conditional Short-circuit Current	50A (250V) (Use 250V/10A fast-blow fuse for short-circuit protection.)
Direct Opening Force	60N minimum (monitor switch)
Direct Opening Action Stroke	1.7mm minimum (return monitor switch), 4.7mm minimum (depress monitor switch)
Operator Strength	500N minimum (when pressing the entire button surface)
Weight (approx.)	26g (without rubber boot) 30g (with rubber boot)

## Operation Characteristics

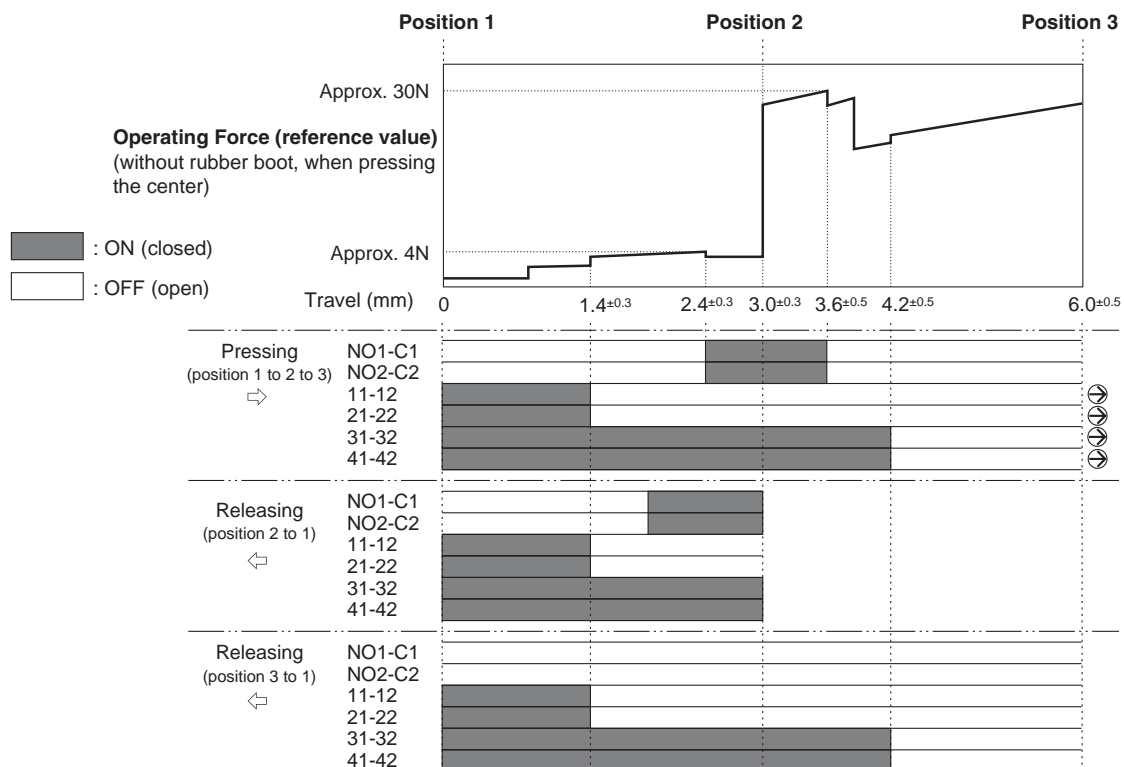

### Notes:

- When a rubber boot is used, the operating force depends on the operating temperature.
- The operating force to shift the switch from position 2 to position 3 can be changed. For details, contact IDEC.

# HE2B Double Three-position Enabling Switches

## Terminal Arrangement (Bottom View)

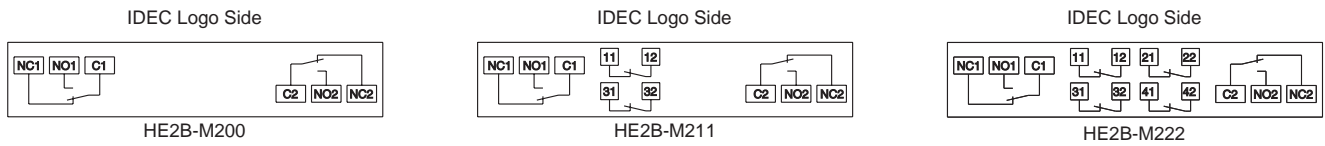

- 3-position switch (note): 2 contacts, terminal nos. between NO1 – C1, NO2 – C2
  - Button return monitor switch: 0 to 2 contacts, terminal nos. between 11 – 12, 21 – 22
  - Button depress monitor switch: 0 to 2 contacts, terminal nos. between 31 – 32, 41 – 42
- Note: Use NO and C terminals for OFF → ON → OFF 3-position switch (NC terminal is not used).

## Dimensions

### Without Rubber Boot

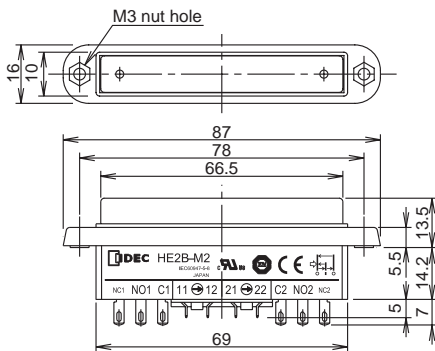

- M3 nuts are supplied with the HE2B enabling switch.

### With Rubber Boot

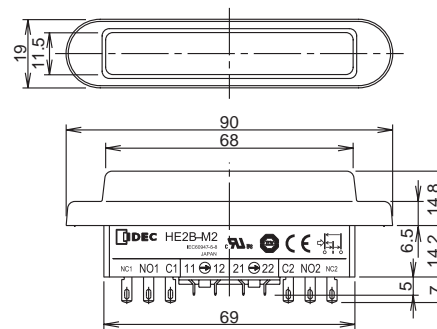

- M3 nuts are installed in the rubber boot.

## Mounting Hole Layout

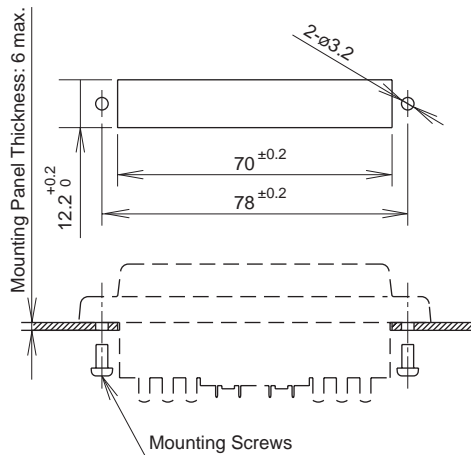

- Mounting screw: Two M3 screws
- Length of mounting screw: Mounting panel thickness + 4 to 5 mm

All dimensions in mm.

## Accessories

### Replacement Rubber Boot

Material	Color	Part No.	Ordering No.	Package Quantity
Silicon Rubber	Y: yellow B: black	HE9Z-D2*	HE9Z-D2*PN10	10
NBR/PVC Polyblend	Gray	HE9Z-D2N1	HE9Z-D2N1PN10	

- Note: Specify a rubber boot color code in place of \* in the Ordering No.
- Can be installed on HE2B-M200/M211/M222 (without rubber boot)

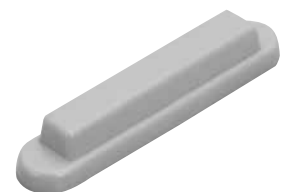

# HE3B ø16mm Rectangular Three-position Enabling Switches

**Rectangular operator part with ø16 mm mounting for easy installation.  
2-contact 3-position enabling switches ideal for installing in small teach pendants.**

- Ergonomically-designed OFF-ON-OFF operation.
- Easy recognition of position 1 to 2 transition is made possible by a snap action switch.
- Sufficient difference in operating force is provided for shifting from position 2 to position 3.
- Low pressure is required to maintain in position 2 allowing for longtime operation.
- Reliable operation is assured even when the edge of the operator button is pressed.
- The switch does not turn ON while being released from position 3 (OFF) to position 1 (OFF) (IEC60204-1, 9.2.5.8).
- Two contacts are provided in a 3-position enabling switch so that even one contact fails due to welding or short-circuit, the other contact can disable machine operation.
- The waterproof rubber boot provides IP65 protection.



## HE3B

Style	Contact Configuration	Part No.	Ordering No.	Package Quantity
Without Rubber Boot	2 contacts (3-position switch)	HE3B-M2	HE3B-M2	1
			HE3B-M2PN10	10
With Rubber Boot Rubber Boot Material: Silicon Rubber Color: Y: yellow, B: black		HE3B-M2P*	HE3B-M2P*	1
			HE3B-M2P*PN10	10
With Rubber Boot Rubber Boot Material: NBR/PVC Polyblend Color: gray		HE3B-M2PN1	HE3B-M2PN1	1
			HE3B-M2PN1PN10	10

Note: Specify a rubber boot color code in place of \* in the Ordering No.

## Contact Ratings

Rated Insulation Voltage (Ui)		125V	
Rated Thermal Current (Ith)		3A	
Rated Voltage (Ue)		30V	125V
Rated Current (Ie)	AC	Resistive Load (AC-12)	— 1A
		Inductive Load (AC-15)	— 0.7A
	DC	Resistive Load (DC-12)	1A 0.2A
		Inductive Load (DC-13)	0.7A 0.1A
Contact Configuration (3-position switch)		2 contacts	

Minimum applicable load (reference value): 5V AC/DC, 1 mA  
(Applicable range is subject to the operating conditions and load.)

## Specifications

Applicable Standards	UL508 (UL recognized), CSA C22.2, No. 14 (c-UL recognized) IEC/EN 60947-5-1, IEC/EN 60947-5-8 (TÜV approval)
Applicable Standards for Use	ISO 12100-1, -2, EN 12100-1, 2, IEC 60204-1 / EN 60204-1 ISO 11161 / prEN 11161, ISO 10218 / EN 775 ANSI/RIA R15.06, ANSI B11.19
Operating Temperature	-25 to +60°C (no freezing) (without rubber boot, with silicon rubber boot) -10 to +60°C (no freezing) (with NBR/PVC polyblend rubber boot)
Relative Humidity	45 to 85% (no condensation)
Storage Temperature	-40 to +80°C (no freezing)
Pollution Degree	2 (inside panel, terminal side) 3 (outside panel, operator side)
Contact Resistance	50 mΩ maximum (initial value)
Insulation Resistance	Between live and dead metal parts: 100 MΩ minimum (500V DC megger) Between terminals of different poles: 100 MΩ minimum (500V DC megger)
Impulse Withstand Voltage	1.5 kV
Operating Frequency	1,200 operations per hour
Mechanical Durability	Position 1 → 2 → 1: 1,000,000 operations minimum Position 1 → 2 → 3 → 1: 100,000 operations minimum
Electrical Durability	100,000 operations minimum
Shock Resistance	Operating extremes: 150 m/s <sup>2</sup> Damage limits: 500 m/s <sup>2</sup>
Vibration Resistance	Operating extremes: 5 to 55 Hz, amplitude 0.5 mm Damage limits: 16.7 Hz, amplitude 1.5 mm
Terminal Style	Solder terminal
Applicable Wire	1 cable, 0.5 mm <sup>2</sup> maximum
Terminal Soldering Heat Resistance	310 to 350°C, 3 seconds maximum
Terminal Tensile Strength	20N minimum
Locking Ring Recommended Tightening Torque	0.68 to 0.88 N·m
Degree of Protection	IP40 (without rubber boot) IP65 (with rubber boot) (IEC 60529)
Conditional Short-circuit Current	50A (250V) (Use 250V/10A fast-blow fuse for short-circuit protection.)
Operator Strength	500N minimum (pressing the entire operator surface)
Weight (approx.)	14g (without rubber boot) 18g (with rubber boot)

# HE3B ø16mm Rectangular Three-position Enabling Switches

## Operation Characteristics

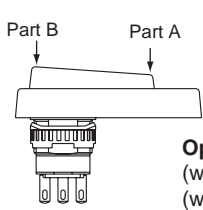

Part A: Approx. 56N  
Part B: Approx. 14N

Part A: Approx. 50N  
Part B: Approx. 12N

**Operating Force (reference value)**  
(without rubber boot)  
(when part A or B is pressed)

■ : ON (closed)  
□ : OFF (open)

Part A: Approx. 10N  
Part B: Approx. 2N

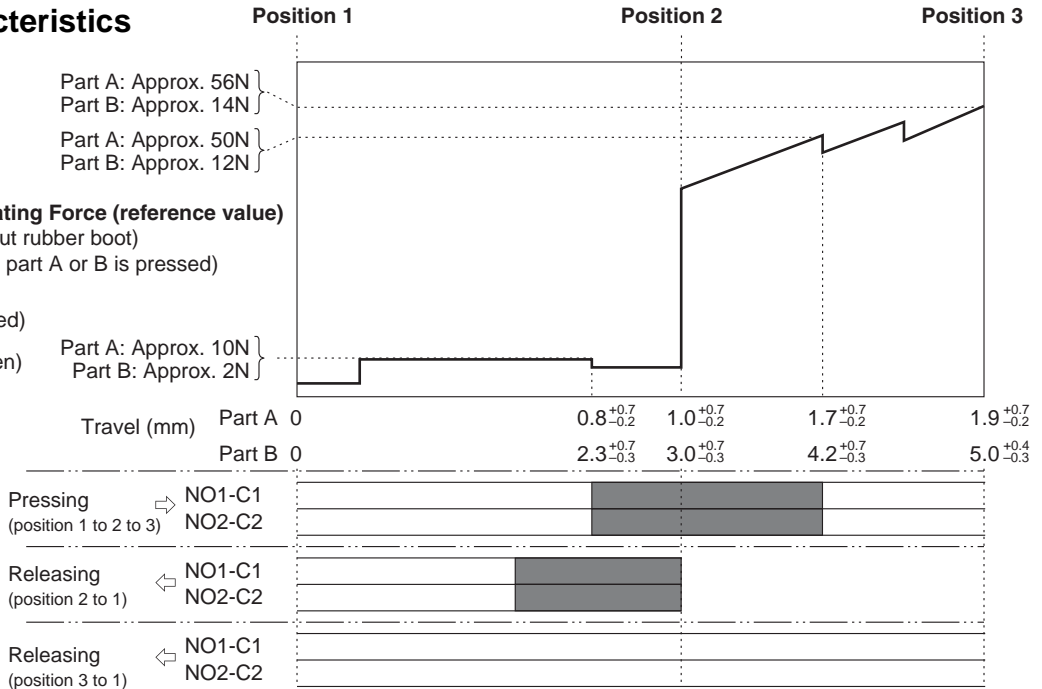

Pressing (position 1 to 2 to 3)	NO1-C1	NO2-C2
Releasing (position 2 to 1)	NO1-C1	NO2-C2
Releasing (position 3 to 1)	NO1-C1	NO2-C2

**Notes:**

- When rubber boot is used, operating force depends on the operating temperature.
- The operating force to shift the switch from position 2 to position 3 can be changed. For details, contact IDEC.

## Terminal Arrangement (Bottom View)

- 3-position switch (Note)
- 2 contacts

Terminal No.: between NO1 and C1, between NO2 and C2

Note: Use NO and C terminals for the 3-position switch of OFF → ON → OFF operation (NC terminal is not used).

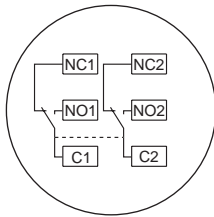

## Mounting Hole Layout

- Recommended tightening torque for locking ring: 0.68 to 0.88 N·m
- Use the locking ring wrench MT-001 for tightening.

Note: To maintain waterproof property of the switch, do not drill through the anti-rotation hole in the mounting panel. When not providing a hole, cut off the anti-rotation projection from the rubber boot. When cutting off the projection, ensure not to make a hole in the rubber boot.

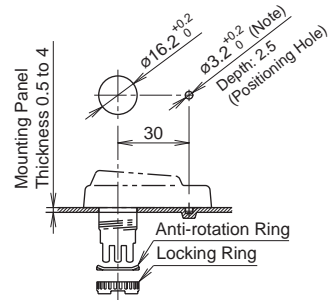

## Dimensions

### Without Rubber Boot

Mounting Panel Thickness: 0.5 to 4

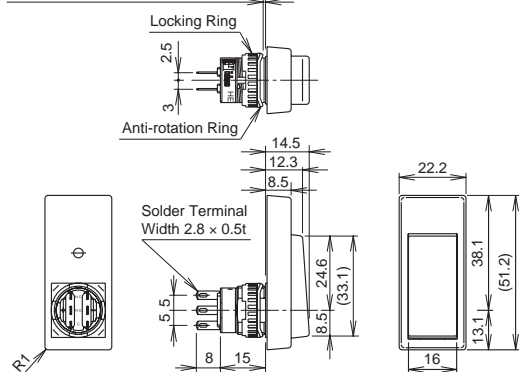

### With Rubber Boot

Mounting Panel Thickness: 0.5 to 4

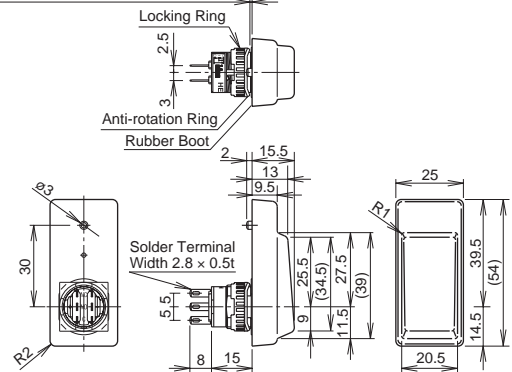

All dimensions in mm.

## Accessories

### Replacement Rubber Boot

Material	Color	Part No.	Ordering No.	Package Quantity
Silicon Rubber	Y: yellow B: black	HE9Z-D3*	HE9Z-D3*PN10	10
NBR/PVC Polyblend	Gray	HE9Z-D3N1	HE9Z-D3N1PN10	

- Specify a rubber boot color code in place of \* in the Ordering No.
- Can be installed on HE3B-M2 (without rubber boot).

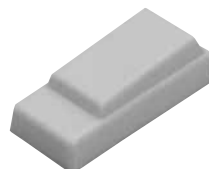

### Locking Ring Wrench

Part No: MT-001  
Material: Metal





# HE5B ø16mm Round Three-position Enabling Switches

**Round-shaped operator for ø16 mm mounting hole.**

**3-position enabling switch with two contacts, ideal for installing in small teaching pendants.**

- Ergonomically-designed OFF-ON-OFF operation.
- Easy recognition of position 1 to 2 transition is made possible by a snap action switch.
- Sufficient difference in operating force is provided for shifting from position 2 to position 3.
- Low pressure is required to maintain position 2, allowing longtime operation.
- Grip style enabling switch housing available.
- The switch does not turn ON when being released from position 3 (OFF when pressed) to position 1 (OFF when released) (IEC60204-1, 9.2.5.8).
- Two contacts are provided in a 3-position enabling switch so that even if one contact fails due to welding or short-circuit, the other contact can disable machine operation.
- The waterproof rubber boot provides IP65 protection.



## HE5B

Style	Contact Configuration	Part No.	Ordering No.	Package Quantity
With Rubber Boot Silicon Rubber Y: yellow B: black  NBR/PVC	2 contacts (3-position switch)	HE5B-M2P*	HE5B-M2P*	1
			HE5B-M2P*PN10	10
		HE5B-M2PN1	HE5B-M2PN1	1
			HE5B-M2PN1PN10	10

- Specify a rubber boot color code in place of \* in the Ordering No.

## Contact Ratings

Rated Insulation Voltage (Ui)			125V	
Rated Thermal Current (Ith)			3A	
Rated Voltage (Ue)			30V	125V
Rated Current (Ie)	AC	Resistive Load (AC-12)	–	0.5A
		Inductive Load (AC-15)	–	0.3A
	DC	Resistive Load (DC-12)	1A	–
		Inductive Load (DC-13)	0.7A	–
Contact Configuration (3-position switch)			2 contacts	

Minimum applicable load (reference): 3V AC/DC, 5mA  
(Applicable operation area depends on the operating conditions and load.)

## Specifications

Applicable Standards	UL508 (UL recognized), CSA C22.2, No. 14 (c-UL recognized) IEC/EN 60947-5-1, IEC/EN 60947-5-8 (TÜV approval)
Applicable Standards for Use	ISO 12100-1, -2, EN 12100-1, 2 / EN292, IEC 60204-1 / EN 60204-1, ISO 11161 / prEN 11161, ISO 10218 / EN 775, ANSI/RIA R15.06, ANSI B11.19
Operating Temperature	Silicon rubber boot: –25 to 60°C (no freezing) NBR/PVC Polyblend rubber boot: –10 to 60°C (no freezing)
Relative Humidity	45 to 85% (no condensation)
Storage Temperature	–40 to +80°C (no freezing)
Pollution Degree	2 (inside panel, terminal side) 3 (outside panel, operator side)
Contact Resistance	50 mΩ maximum (initial value)
Insulation Resistance	Between live and dead metal parts: 100 MΩ minimum (500V DC megger) Between terminals of different pole: 100 MΩ minimum (500V DC megger)
Impulse Withstand Voltage	1.5 kV
Operating Frequency	1,200 operations per hour
Mechanical Durability	Position 1 → 2 → 1: 1,000,000 operations minimum Position 1 → 2 → 3 → 1: 100,000 operations minimum
Electrical Durability	100,000 operations minimum
Shock Resistance	Operating extremes: 150 m/s <sup>2</sup> Damage limits: 500 m/s <sup>2</sup>
Vibration Resistance	Operating extremes: 5 to 55 Hz, amplitude 0.5 mm Damage limits: 5 to 55 Hz, amplitude 1.5 mm
Terminal Style	Solder terminal
Applicable Wire	0.5 mm <sup>2</sup> maximum per line
Terminal Soldering Heat Resistance	310 to 350°C, 3 seconds maximum
Terminal Tensile Strength	20 N minimum
Locking Ring Recommended Tightening Torque	0.29 to 0.49 N·m
Degree of Protection	IP65 (IEC 60529)
Conditional Short-circuit Current	50A (125V) (Use 250V/10A fast-blow fuse for short circuit protection.)
Operator Strength	250N minimum (when pressing the entire operator surface)
Weight (approx.)	9g

# HE5B $\phi$ 16mm Round Three-position Enabling Switches

## Operating Characteristics

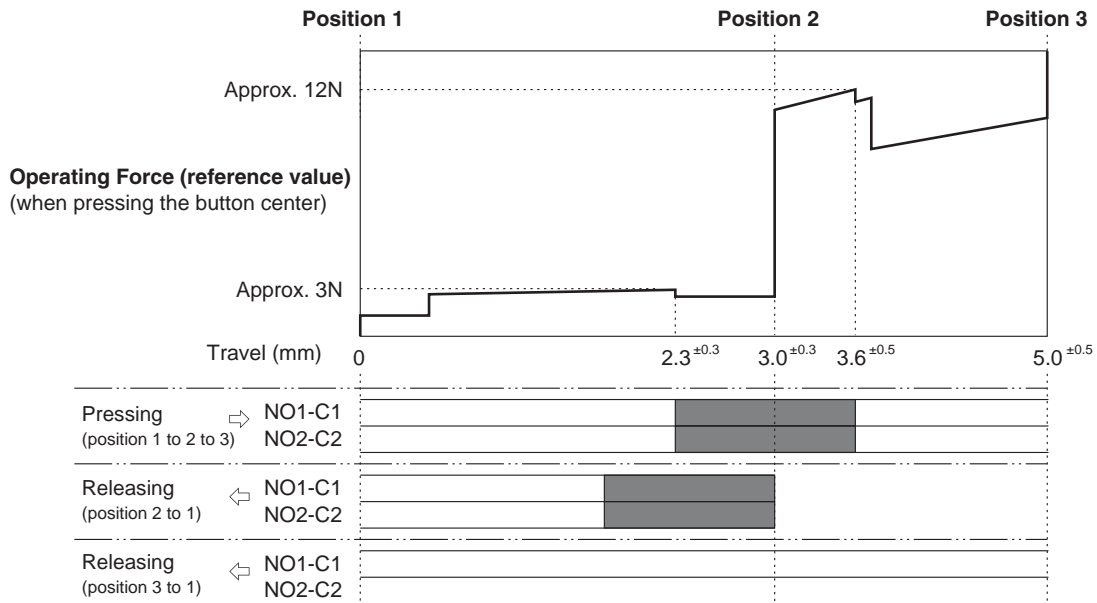

### Notes:

- Operating force depends on ambient temperature.
- The operating force to shift the switch from position 2 to position 3 can be changed. For details, consult IDEC.

## Terminal Arrangement (Bottom View)

- 3-position switch (Note)
- 2 contacts

Terminal No.: between NO1 and C1,  
NO2 and C2

Note: For OFF  $\rightarrow$  ON  $\rightarrow$  OFF 3-position switches, use NO and C terminals (NC terminal is not used).

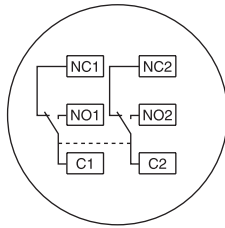

## Mounting Hole Layout

- Recommended Tightening Torque for Locking Ring: 0.29 to 0.49 N·m
- Use the MT-001 locking ring wrench for tightening.

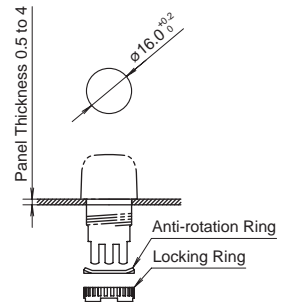

## Dimensions

### With Rubber Boot

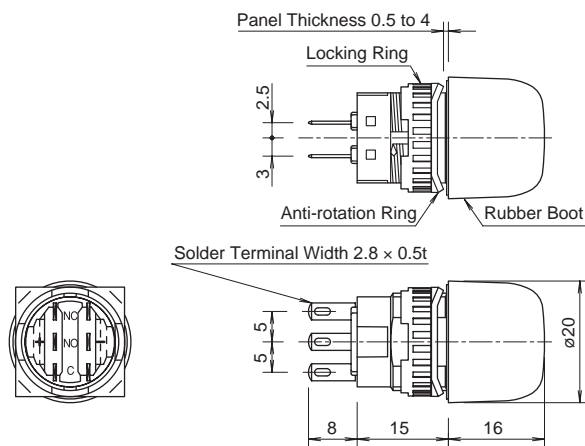

All dimensions in mm.

## Accessories

### Replacement Rubber Boot

Rubber Boot Material	Color	Part No.	Ordering No.	Package Quantity
Silicon Rubber	B: black Y: yellow	HE9Z-D5*	HE9Z-D5*PN10	10
NBR/PVC Polyblend	Gray	HE9Z-D5N1	HE9Z-D5N1PN10	

- Specify a rubber boot color code in place of \* in the Ordering No.



### Locking Ring Wrench

Part No: MT-001  
Material: Metal



# HE5B ø16mm Round Three-position Enabling Switches

## Grip Style Enabling Switch Housing

HE5B enabling switches can be installed in the HE9Z-GSH51 grip style enabling switch housing to be used as 3-position grip style enabling switches.

Part No.	Ordering No.	Package Quantity
HE9Z-GSH51	HE9Z-GSH51	1

### Specifications

Applicable Standards	IEC/EN 60529 UL50
Operating Temperature	-25 to 60°C (no freezing)
Relative Humidity	45 to 85% RH (no condensation)
Storage Temperature	-40 to 80°C (no freezing)
Pollution Degree	3
Shock Resistance	Damage limits: 500 m/s <sup>2</sup>
Vibration Resistance	Damage limits: 5 to 55 Hz, amplitude 0.5 mm
Electric Shock Protection Class	Class II (when using HE5B-M2P*)
Applicable Cable	Outside diameter ø4.5 to 10 mm
Conduit Port Size	M16 (cable gland is supplied with the grip style enabling switch housing)
Degree of Protection	IP65 (with HE5B-M2P*) NEMA type 4X indoor use only (with HE5B-M2P*)
Weight (approx.)	65g (grip style enabling switch housing only)

- The above specifications are for the grip style enabling switch housing only. For enabling switch, see the HE5B specifications on page 14.
- The following switches can be installed on the grip style enabling switch housing to be used as hand-held switches.
  - AB6M pushbuttons (IP65, except for AB6M-V)
  - AS6M selector switches (IP65)
  - AS6M key selector switches (IP65)



### Notes:

- The HE9Z-GSH51 grip style enabling switch housing does not include the HE5B enabling switch. The enabling switch must be ordered separately.
- The HE5B enabling switch must be installed and wired to the HE9Z-GSH51 grip style enabling switch housing by the user. For information on wiring, see the instruction sheet supplied with the HE9Z-GSH51.

## Dimensions

### HE9Z-GSH51

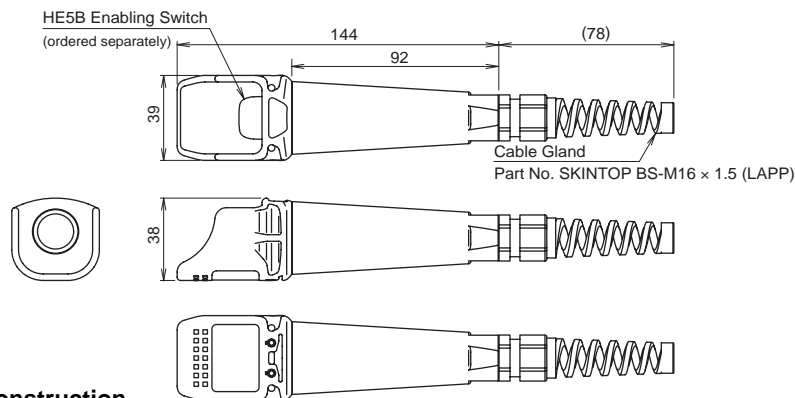

### HE9Z-GSH51 + HE5B Construction

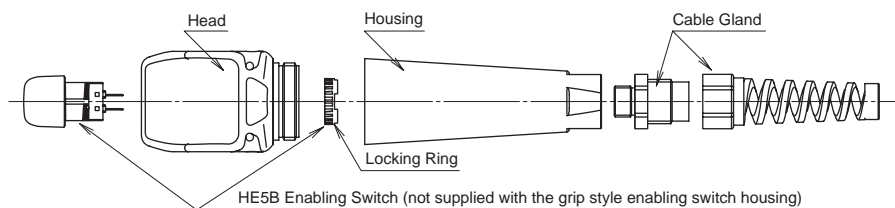

- Anti-rotation ring is not required when installing the HE5B enabling switch on the HE9Z-GSH51 grip style enabling switch housing. Use the locking ring only.

## Mounting Bracket

Part No: HE9Z-GH1

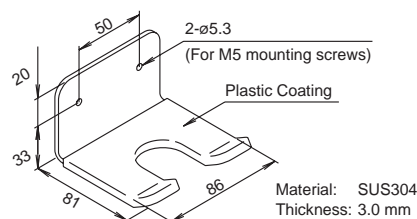

All dimensions in mm.

# HE6B Rectangular Three-position Enabling Switches

## 3-position enabling switch with monitoring contacts—Smallest in its class.

- Ergonomically-designed OFF-ON-OFF operation.
- The switch does not turn ON while returning from position 3 (OFF) to position 1 (OFF)  
IEC 60204-1 (2005), 10.9  
IEC 60947-5-8 (2006), 7.1.9
- Some teach pendants are equipped with two 3-position enabling switches, and when one switch is pressed to position 3 (OFF), the other switch must not enable machine operation even when pressed to position 2. Enabling of machine operation must resume after both switches are released. The monitoring switches monitor the OFF status of 3-position enabling switch, whether the button is returned to position 1 or the button is pressed to position 3 (monitor switches have direct opening action mechanism.)
- Two contacts are provided in a 3-position enabling switch so that even if one contact fails due to welding or short circuit, the other contact can disable machine operation.
- The waterproof rubber boot provides IP65 protection.



## HE6B

Style		Contact Configuration/No. of Contacts			Part No.	Ordering No.	Package Quantity
		3-position Switch	Return Monitor Switch	Depress Monitor Switch			
With Rubber Boot	Rubber Boot Material: Silicon Rubber Color: Y: yellow B: black	2	0	0	HE6B-M200*	HE6B-M200*	1
						HE6B-M200*PN10	10
		2	1	1	HE6B-M211*	HE6B-M211*	1
						HE6B-M211*PN10	10

- Specify rubber boot color code in place of \* in the Part No.

## Part No. Development

<b>HE6B - M 2 0 0 *</b>	
<b>3-position Switch</b> 2: 2 contacts  <b>Monitor Switch</b> 00: No switch 11: 1 contact of return monitor switch 1 contact of depress monitor switch 20: 2 contacts of return monitor switch 02: 2 contacts of depress monitor switch (20 and 02 are not standard. Contact IDEC for details.)	<b>Rubber Boot Material, Color</b> Blank: No rubber boot Y: Silicon rubber, yellow (Note 1) B: Silicon rubber, black (Note 1) [N1]: NBR/PVC polyblend, gray (Not standard. Contact IDEC) (Note 2)

- Note 1: Silicon rubber: Can be used in general factories. Remaining flexible in cold temperatures. Suitable for applications in a wide operating temperature range.  
 Note 2: NBR/PVC polyblend: Oil-proof. Suitable for environments subjected to machine oil and for painting robots where silicon rubber cannot be used.

## Accessories

### Replacement Rubber Boot

Material, Color	Part No.	Ordering No.	Package Quantity
Silicon Rubber Y: yellow B: black	HE9Z-D6*	HE9Z-D6*PN10	10



- Specify rubber boot color code in place of \* in the Ordering No.

# HE6B Rectangular Three-position Enabling Switches

## Specifications

Applicable Standards	IEC/EN60947-5-1 IEC/EN60947-5-8 (TÜV approved) GS-ET-22 (TÜV approved) UL508 (UL recognized) CSA C22.2 No.14 (c-UL recognized)
Applicable Standards for Use	ISO 12100/EN ISO 12100, IEC 60204-1/EN 60204-1, ISO 11161/EN ISO 11161, ISO 10218-1/EN ISO 10218-1, ANSI/RIA/ISO 10218-1, ANSI/RIA/R15.06, ANSI B 11.19 ISO 13849-1/EN ISO 13849-1
Operating Temperature	-25 to +60°C (no freezing)
Relative Humidity	45 to 85% RH (no condensation)
Storage Temperature	-40 to +80°C (no freezing)
Pollution Degree	2 (inside panel, terminal side) 3 (outside panel, operator side)
Contact Resistance	50 mΩ maximum (initial value)
Insulation Resistance	Between live and dead metal parts: 100 MΩ minimum (500V DC megger) Between terminals of different poles: 100 MΩ minimum (500V DC megger)
Impulse Withstand Voltage	1.5 kV (3 position switch) 2.5 kV (monitor switch)
Operating Frequency	1200 operations per hour
Mechanical Durability	Position 1→2→1: 1,000,000 operations minimum Position 1→2→3→1: 100,000 operations minimum
Electrical Durability	100,000 operations minimum (rated load) 1,000,000 operations minimum (24V AC/DC, 100 mA)
Shock Resistance	Operating extremes: 150 m/s <sup>2</sup> Damage limits: 500 m/s <sup>2</sup>
Vibration Resistance	Operating extremes: 5 to 55 Hz, amplitude 0.5 mm Damage limits: 16.7 Hz, amplitude 1.5 mm
Terminal Style	Solder terminal
Applicable Wire	1 cable, 0.5 mm <sup>2</sup> maximum
Solder Terminal Heat Resistance	310 to 350°C, 3 seconds maximum
Terminal Tensile Strength	20N minimum
Locking Ring Recommended Tightening Torque	0.5 to 0.8 N-m
Degree of Protection	IP65 (IEC 60529)
Conditional Short-circuit Current	50A (125V): 3-position switch (Use 120V/10A fast acting type fuse for short circuit protection.) (IEC 60127-1) 50A (250V): monitor switch (Use 250V/10A fast acting type fuse for short circuit protection.) (IEC 60127-1)
Direct Opening Force	40N minimum (monitor switch)
Direct Opening Stroke (when pressing the entire button surface)	0.9 mm minimum (return monitor switch) 4.0 mm minimum (depress monitor switch)
Operator Strength	250N minimum (when pressing the entire button surface)
Weight (approx.)	17g

## Dimensions

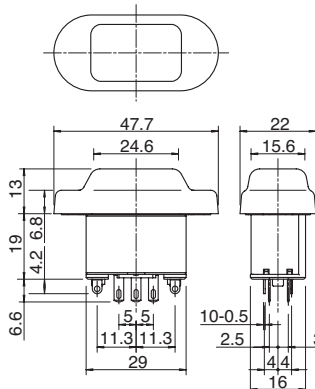

## Mounting Hole Layout

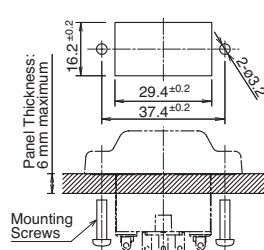

- Mounting screws: M3 screw × 2 (not attached and must be supplied by the user)
- Mounting screw length: 5 to 6 mm (panel thickness + gasket)

All dimensions in mm.

## Ratings

Rated Insulation Voltage (Ui)		125V (monitor switch: 250V)				
Rated Thermal Current (Ith)		3A				
Rated Voltage (Ue)		30V	125V	250V		
Rated Current (Ie)	3-position switch	AC	Resistive Load (AC-12)	—	0.5A	—
			Inductive Load (AC-15)	—	0.3A	—
		DC	Resistive Load (DC-12)	1A	—	—
		Inductive Load (DC-13)	0.7A	—	—	
	Return monitor switch	AC	Resistive Load (AC-12)	—	2A	1A
			Inductive Load (AC-15)	—	1A	0.5A
DC		Resistive Load (DC-12)	2A	0.4A	0.2A	
	Inductive Load (DC-13)	1A	0.22A	0.1A		
Contact Configuration	3-position switch		2 contacts			
	Return monitor switch		0 to 1 contact			
	Depress monitor switch		0 to 1 contact			

- Minimum applicable load (reference value): 3V AC/DC, 5 mA (Applicable operation area depends on the operating conditions and load.)

### TÜV ratings:

3 position switch:  
AC-12 125V/0.5A  
DC-12 30V/1A  
DC-13 30V/0.7A

Monitor Switch:  
AC-15 250V/0.5A  
DC-13 125V/0.22A  
DC-13 30V/1A

### UL ratings:

3-position switch:  
125V AC/0.5A (Resistive)  
30V DC/1A (Resistive)

Monitor switch:  
250V AC/0.5A (General use)  
30V DC/1A (General use)

## Operating Characteristics

### HE6B-M211

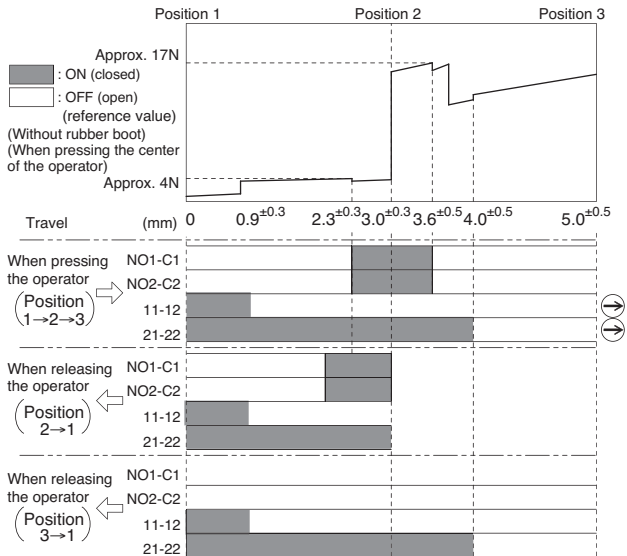

### Notes:

- When a rubber boot is used, the operating force depends on the operating temperature.
- The operating force to move the button from position 2 to position 3 can be changed. For details, contact IDEC.

## Terminal Arrangement (bottom view)

### HE6B-M211

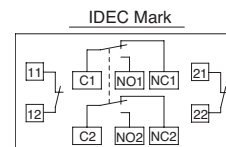

- 3-position switch (Note): 2 contacts
- Return monitor switch: 1 contact, terminal nos. 11-12
- Depress monitor switch: 1 contact, terminal nos. 21-22
- There are no terminal nos. 11-22 and 21-22 for HE6B-M200.

Note: Use NO and C terminals for OFF→ON→OFF 3-position switch (NC terminal is not used.)



# HE1G Grip Style Three-position Enabling Switches

## Ergonomically designed grip style enabling switch with two 3-position enabling switches.

- Ergonomically-designed OFF-ON-OFF operation.
- Direct opening action mechanism for shifting from position 2 (ON) to position 3 (OFF) (EN 60977-5-1/IEC 60947-5-1, Annex K).
- The switch does not turn ON when being released from position 3 (OFF when pressed) to position 1 (OFF when released) (IEC60204-1, 9.2.5.8).
- Two contacts are provided so that even if one contact fails due to welding or short-circuit, the other contact can disable machine operation.
- Emergency stop switch and momentary pushbutton versions are available.
- Cable gland supplied.
- HE1G-21SM is IP66 waterproof.
- Can be used for applications required by the ANSI robot standard.

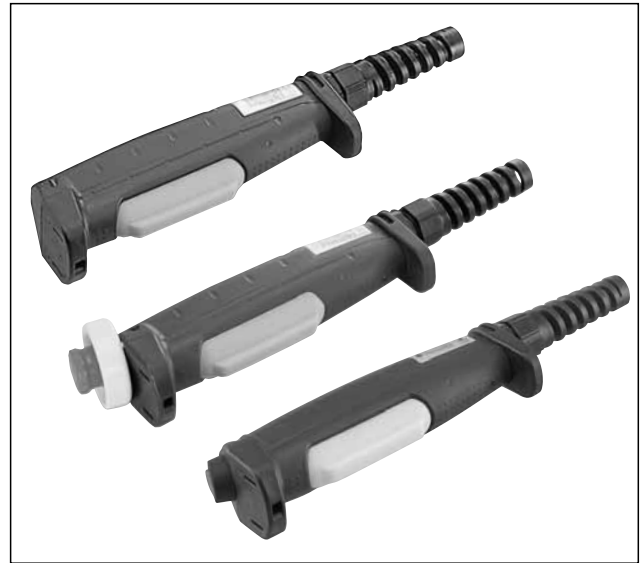

## HE1G

Contact Configuration			Rubber Boot	Part No.	Package Quantity	
3-position Switch	Monitor Switch	Pushbutton				
2 contacts	With (1NC)	Without	Silicon Rubber / yellow	<b>HE1G-21SM</b>	1	
			NBR/PVC Polyblend / gray	<b>HE1G-21SM-1N</b>		
		Momentary Pushbutton (1NO) (1NO: AB6M-M1PB)	Silicon Rubber / yellow	<b>HE1G-21SMB</b>		
		NBR/PVC Polyblend / gray	<b>HE1G-21SMB-1N</b>			
	Without	Emergency Stop Switch (2NC) (2NC: HA1E-V2S2R)		Silicon Rubber / yellow		<b>HE1G-20ME</b>
				NBR/PVC Polyblend / gray		<b>HE1G-20ME-1N</b>
Momentary Pushbutton (2NO) (2NO: AB6M-M2PB)			Silicon Rubber / yellow	<b>HE1G-20MB</b>		
		NBR/PVC Polyblend / gray	<b>HE1G-20MB-1N</b>			

## Ratings

### Contact Ratings

Rated Insulation Voltage (Ui)				250V (momentary pushbutton switch: 125V)		
Rated Thermal Current (Ith)				3A		
Rated Voltage (Ue)				30V	125V	250V
Rated Current (Ie)	3-position Switch (terminal No. 1-2, 3-4)	AC	Resistive Load (AC-12)	—	3A	1.5A
			Inductive Load (AC-15)	—	1.5A	0.75A
		DC	Resistive Load (DC-12)	2A	0.4A	0.2A
			Inductive Load (DC-13)	1A	0.22A	0.1A
	Monitor Switch (HE1G-21SM/HE1G-21SMB, terminal No. 5-6)	AC	Resistive Load (AC-12)	—	2A	1A
			Inductive Load (AC-15)	—	1A	0.5A
		DC	Resistive Load (DC-12)	2A	0.4A	0.2A
			Inductive Load (DC-13)	1A	0.22A	0.1A
	Emergency Stop Switch (HE1G-20ME, terminal No. 5-6, 7-8)	AC	Resistive Load (AC-12)	—	—	—
			Inductive Load (AC-15)	—	—	0.5A
		DC	Resistive Load (DC-12)	—	—	—
			Inductive Load (DC-13)	—	—	0.1A
Momentary Pushbutton Switch (HE1G-20M1SMB, terminal No. 7-8, HE1G-20MB, terminal No. 5-6, 7-8)	AC	Resistive Load (AC-12)	—	0.5A	—	
		Inductive Load (AC-15)	—	0.3A	—	
	DC	Resistive Load (DC-12)	1A	0.2A	—	
		Inductive Load (DC-13)	0.7A	0.1A	—	
Contact Configuration	3-position Switch			2 contacts		
	Monitor Switch			0 or 1 contact		
	Emergency Stop Switch			0 or 2 contacts		
	Momentary Pushbutton Switch			0 to 2 contacts		

- Minimum applicable load (reference value): 3V AC/DC, 5 mA  
(Applicable range is subject to the operating conditions and load.)

# HE1G Grip Style Three-position Enabling Switches

## Specifications

Applicable Standards	UL508 (UL listed), CSA C22.2, No. 14 (c-UL listed), IEC/EN 60947-5-1 (TÜV/BG approval), GS-ET-22 (TÜV/BG approval),
Applicable Standards for Use	ISO 12100-1, -2, EN12100-1, -2, IEC 60204-1 / EN 60204-1, ISO11161 / prEN11161, ISO 10218 / EN 775, ANSI/RIA R15.06, ANSI B11.19
Operating Temperature	Silicon rubber boot: -25 to 60°C (no freezing) NBR/PVC Polyblend rubber boot: -10 to 60°C (no freezing)
Relative Humidity	45 to 85% (no condensation)
Storage Temperature	-40 to +80°C (no freezing)
Pollution Degree	3
Contact Resistance	100 mΩ maximum (initial value)
Insulation Resistance	Between live and dead metal parts: 100 MΩ minimum (500V DC megger) Between terminals of different pole: 100 MΩ minimum (500V DC megger)
Impulse Withstand Voltage	2.5 kV (momentary pushbuttons: 1.5kV)
Electric Shock Protection Class	Class II (IEC 61140)
Operating Frequency	1,200 operations per hour
Mechanical Durability	Position 1 → 2 → 1: 1,000,000 operations minimum Position 1 → 2 → 3 → 1: 100,000 operations minimum
Electrical Durability	100,000 operations minimum
Shock Resistance	Operating extremes: 150 m/s <sup>2</sup> Damage limits: 1,000 m/s <sup>2</sup>
Vibration Resistance	Operating extremes: 5 to 55 Hz, amplitude 0.5 mm minimum Damage limits: 16.7 Hz, amplitude 1.5 mm minimum
Applicable Wire	0.14 to 1.5 mm <sup>2</sup> (AWG16-25)
Applicable Cable	Outside diameter ø7 to 13 mm
Conduit Port Size	M20 (cable gland is supplied with the grip style enabling switch)
Terminal Tensile Strength	20N minimum
Terminal Screw Tightening Torque	0.5 to 0.6 N·m
Degree of Protection	HE1G-21SM: IP66 (IEC 60529) HE1G-20ME: IP65 (IEC 60529) HE1G-20MB: IP65 (IEC 60529) HE1G-21SMB: IP65 (IEC 60529)
Conditional Short-circuit Current	50A (250V) (Use 250V/10A fast-blow fuse for short circuit protection.)
Direct Opening Force	90N minimum (3-position switch and monitor switch)
Operator Strength	500N minimum (when pressing the entire button surface)
Weight (approx.)	HE1G-21SM: 210g HE1G-20ME: 250g HE1G-20MB/HE1G-21SMB: 220g

## Operating Characteristics

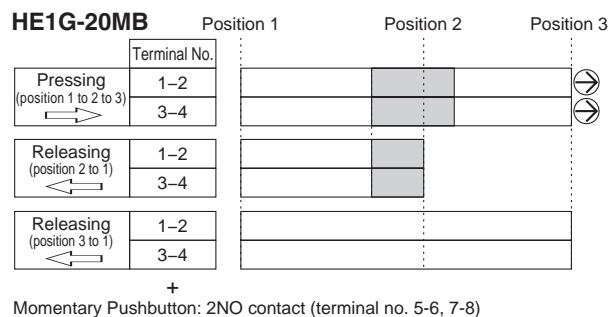
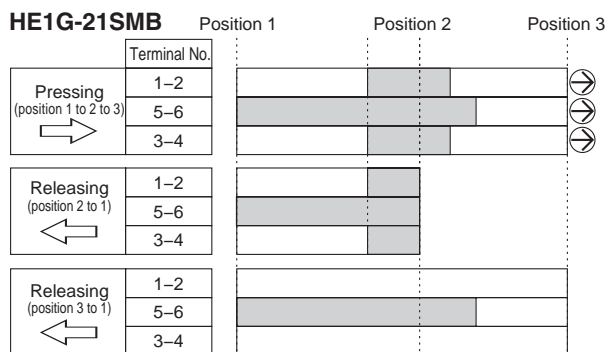
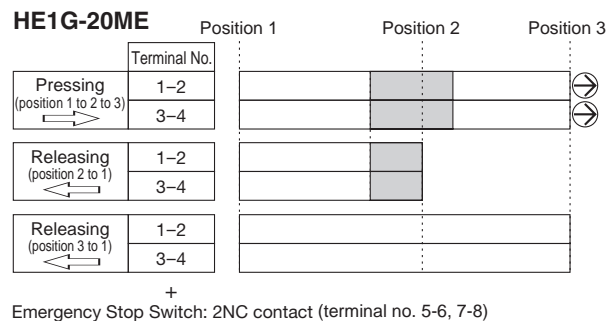
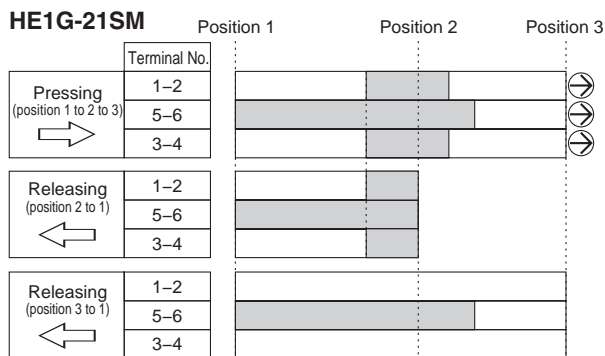

+  
Momentary Pushbutton: 1NO contact (terminal no. 7-8)

■ : contact ON (closed) □ : contact OFF (open)

### Notes:

- 3-position switches operate with direct opening action ⊕ when shifting from position 2 to position 3.
- For the output of the enabling device, use terminals 1-2 and 3-4.
- The above operation characteristics show when the center of the button is pressed. Pressing the edge of a button turns on one contact earlier than the other contact, causing a delay in operation.

# HE1G Grip Style Three-position Enabling Switches

## Dimensions

HE1G-21SM

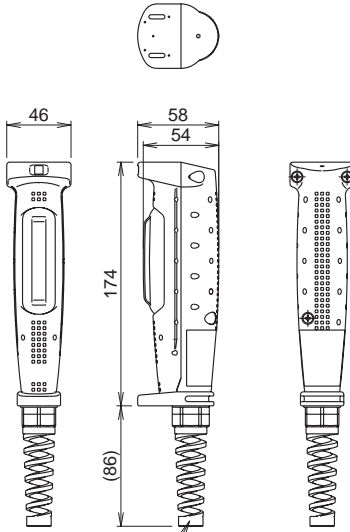

Cable Gland (supplied with grip style enabling switch)  
Part No.: SKINTOP BS-M20 x 1.5 (LAPP)

HE1G-20ME

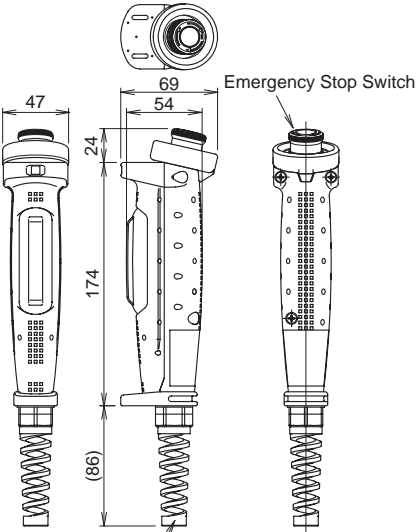

Cable Gland (supplied with grip style enabling switch)  
Part No.: SKINTOP BS-M20 x 1.5 (LAPP)

HE1G-20MB / HE1G-21SMB

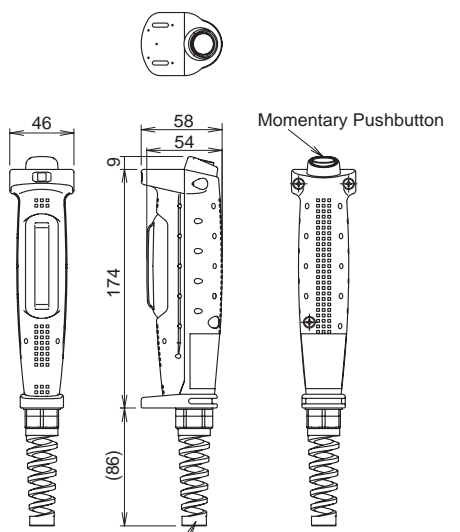

Cable Gland (supplied with grip style enabling switch)  
Part No.: SKINTOP BS-M20 x 1.5 (LAPP)

## Accessories

### Mounting Bracket (for hanging grip style enabling switch)

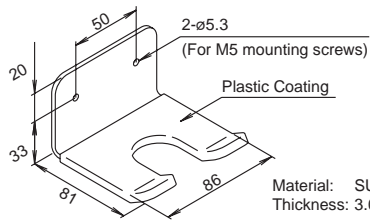

Material: SUS304  
Thickness: 3.0 mm

All dimensions in mm.

- Can be used with HE1G/HE1G-L//HE9Z-GSH51 only.

### Rubber Boot Kit (replacement)

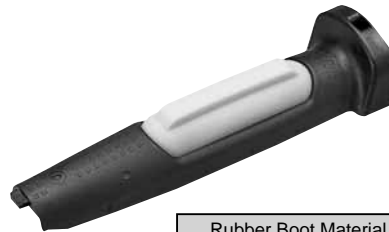

Rubber Boot Material	Part No.
Silicon Rubber / yellow	HE9Z-GBK1
NBR/PVC Polyblend / gray	HE9Z-GBK1-1N

# HE1G-L Grip Style Three-position Enabling Switches

The distinctive tactile feedback makes it easy to know the current position of the switch. Light operating force ideal for long-hour operation

- Ergonomically-designed OFF-ON-OFF operation.
- The switch does not turn ON when being released from position 3 (OFF when pressed) to position 1 (OFF when released) (IEC 60204-1, 9.2.5.8).
- Two contacts are provided so that even if one contact fails due to welding or short-circuit, the other contact can disable machine operation.
- Monitor switch is direct opening action.
- The distinctive tactile feedback when shifting to position 2 (enabling position) makes it easier to know where the enabling switch is currently positioned—position 1 (OFF), 2 (ON), or 3 (OFF).
- Lighter operating force on position 2 assures more comfortable, stress-free operation when operating long hours.
- Emergency stop switch and momentary pushbutton versions are available.
- Screw terminal and internal connector models can be selected.
- IP66 degree of protection (HE1G-L21SM)
- HE2B enabling switch is installed (  ).

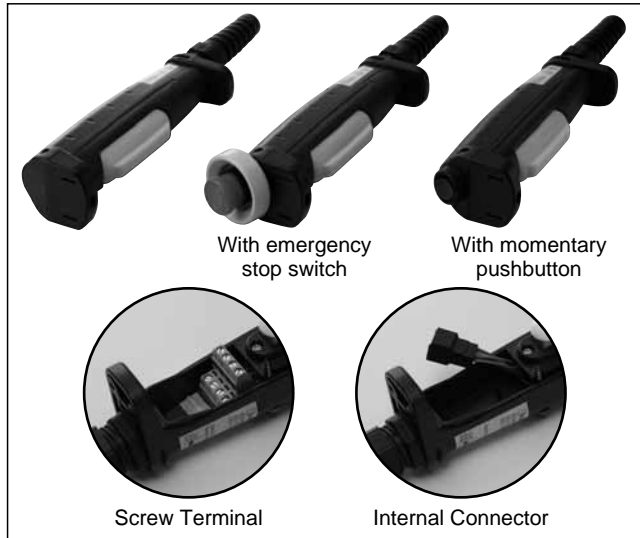

## HE1G-L

Contact Configuration			Rubber Boot	Wiring Style	Part No.	
3-position Switch	Monitor Switch	Additional Pushbutton Switch				
2 contacts	With (1NC)	Without	Silicon Rubber / yellow (Note 1)	Terminal Block	<b>HE1G-L21SM</b>	
			NBR/PVC Polyblend / gray (Note 2)	Internal Connector	<b>HE1G-L21SMC</b>	
		Momentary Pushbutton Switch (1NO: AB6M-M1PB)	Silicon Rubber / yellow	Terminal Block	<b>HE1G-L21SMB</b>	
			NBR/PVC Polyblend / gray	Internal Connector	<b>HE1G-L21SMB-1N</b>	
			Emergency Stop Switch (2NC: HA1E-V2S2R)	Silicon Rubber / yellow	Terminal Block	<b>HE1G-L20ME</b>
				NBR/PVC Polyblend / gray	Internal Connector	<b>HE1G-L20MCE</b>
	Without	Momentary Pushbutton Switch (2NO: AB6M-M2PB)	Silicon Rubber / yellow	Terminal Block	<b>HE1G-L20MB</b>	
			NBR/PVC Polyblend / gray	Internal Connector	<b>HE1G-L20MCB-1N</b>	
		Emergency Stop Switch (2NC: HA1E-V2S2R)	Silicon Rubber / yellow	Terminal Block	<b>HE1G-L20ME</b>	
			NBR/PVC Polyblend / gray	Internal Connector	<b>HE1G-L20MCE</b>	
			Silicon Rubber / yellow	Terminal Block	<b>HE1G-L20MB</b>	
			NBR/PVC Polyblend / gray	Internal Connector	<b>HE1G-L20MCB-1N</b>	

Note 1: Silicon rubber: Can be used in general factories. Remains flexible at cold temperatures. Suitable to applications in a wide operating temperature range.  
 Note 2: NBR/PVC polyblend: Oil-proof. Suitable for environments subjected to machine oil and painting robot where silicon rubber cannot be used.

## Contact Ratings

Rated Insulation Voltage (Ui)		250V (momentary pushbutton: 125V)					
Rated Thermal Current (Ith)		2.5A (Note)					
Rated Voltage (Ue)		30V	125V	250V			
Rated Current (Ie)	Grip Style Enabling Switch	3-position Switch (Terminal No.1-2/A1-B1,3-4/A2-B2)	AC	Resistive Load (AC-12)	—	1A	0.5A
			DC	Resistive Load (DC-12)	1A	0.2A	—
		Monitor Switch (HE1G-L21SM/HE1G-L21SMB, Terminal No.5-6/A3-B3)	AC	Resistive Load (AC-12)	—	2A	1A
			DC	Resistive Load (DC-12)	2A	0.4A	0.2A
	Pushbutton	Emergency Stop Switch (HE1G-L20M, Terminal No. 5-6/A3-B3, 7-8/A4-B4)	AC	Resistive Load (AC-12)	—	—	—
			DC	Resistive Load (DC-12)	—	—	—
Momentary Pushbutton (HE1G-L20M, Terminal No.5-6/A3-B3,7-8/A4-B4) (HE1G-L21SM, Terminal No.7-8/A4-B4)		AC	Resistive Load (AC-12)	—	0.5A	—	
		DC	Resistive Load (DC-12)	1A	0.2A	—	

• Minimum applicable load (reference value): 3V AC/DC, 5 mA (Applicable range is subject to the operating conditions and load.)  
 Note: Operating temp. 40 to up to +50°C (not included): 2A (4 circuits)  
 50 to +60°C: 1.5A (3 or 4 circuits)

# HE1G-L Grip Style Three-position Enabling Switches

## Specifications

Applicable Standards	UL508 (UL listed, screw terminal only) CSA C22.2, No. 14 (c-UL listed, screw terminal only) IEC/EN 60947-5-1 (TÜV/BG approval) GS-ET-22 (TÜV/BG approval)
Applicable Standards for Use	ISO 12100-1, -2, IEC 60204-1/EN 60204-1, ISO11161 / prEN11161, ISO 10218 / EN 775, ANSI/RIA R15.06, ANSI B11.19
Operating Temperature	Silicon rubber boot: -25 to 60°C (no freezing) NBR/PVC Polyblend rubber boot: -10 to 60°C (no freezing)
Relative Humidity	45 to 85% (no condensation)
Storage Temperature	-40 to +80°C (no freezing)
Pollution Degree	3
Contact Resistance	100 mΩ maximum (initial value)
Insulation Resistance	Between live and dead metal parts: 100 MΩ minimum (500V DC megger) Between terminals of different pole: 100 MΩ minimum (500V DC megger)
Impulse Withstand Voltage	Screw terminal: 2.5 kV (momentary pushbuttons: 1.5 kV) Internal connector: 1.5 kV
Electric Shock Protection Class	Class II (IEC 61140)
Operating Frequency	1,200 operations per hour
Mechanical Durability	Position 1 → 2 → 1: 1,000,000 operations minimum Position 1 → 2 → 3 → 1: 100,000 operations minimum
Electrical Durability	100,000 operations minimum (rated load) 1,000,000 operations minimum (24V AC/DC, 100 mA)
Shock Resistance	Operating extremes: 150 m/s <sup>2</sup> Damage limits: 1,000 m/s <sup>2</sup>
Vibration Resistance	Operating extremes: 5 to 55 Hz, amplitude 0.5 mm minimum Damage limits: 16.7 Hz, amplitude 1.5 mm minimum
Applicable Wire	Screw terminal: 0.14 to 1.5 mm <sup>2</sup> (AWG16 to 25) Internal connector: 0.05 to 0.86 mm <sup>2</sup> (AWG18 to 30)
Applicable Cable	Outside diameter ø7 to 13 mm
Conduit Port Size	M20 (cable gland is supplied with the grip style enabling switch)
Terminal Tensile Strength	20N minimum
Terminal Screw Tightening Torque	0.5 to 0.6 N·m
Degree of Protection	HE1G-L21SM: IP66 (IEC 60529) HE1G-L20ME: IP65 (IEC 60529) HE1G-L20MB: IP65 (IEC 60529) HE1G-L21SMB: IP65 (IEC 60529)
Conditional Short-circuit Current	50A (250V) (Use 250V/10A fast-blow fuse for short circuit protection.)
Direct Opening Force	70N minimum (monitor switch)
Operator Strength	500N minimum (when pressing the entire button surface)
Weight (approx.)	HE1G-L21SMC: 190g HE1G-L21SM/L21SMCB/L20MCB: 200g HE1G-L21SMB/L20MB: 210g HE1G-L20MCE: 230g HE1G-L20ME: 240g

## Operating Characteristics

### HE1G-L21SM, HE1G-L21SMC, HE1G-L21SM-1N, HE1G-L21SMC-1N

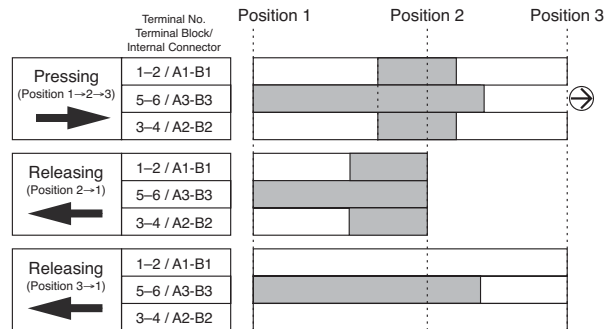

■ : contact ON (closed) □ : contact OFF (open)

- Terminals 1-2/A1-B1 and 3-4/A2-B2 are outputs of the 3-position enabling switch.
- Terminals 5-6/A3-B3 are outputs of the monitor switch.
- The above operation characteristics show when the center of the grip style enabling switch button is pressed. Because two contacts are designed to operate independently, pressing the edge of the button turns on one contact earlier than the other contact, causing a delay in operation. To avoid this, always press the center of the button.

## Dimensions

### HE1G-L21SM, HE1G-L21SMC, HE1G-L21SM-1N, HE1G-L21SMC-1N

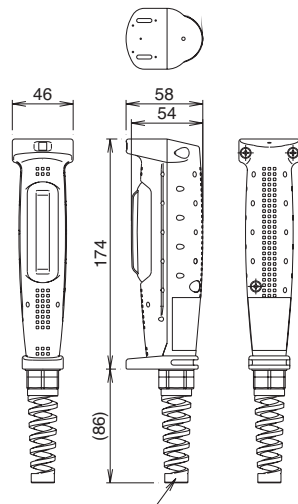

Cable Gland (supplied with grip style enabling switch)  
Part No.: SKINTOP BS-M20 × 1.5 (LAPP)

Internal Connector Terminal No.

B1	B2	B3	B4
A1	A2	A3	A4

## Connector

- Tyco Electronics D-1200D series
- Receptacle housing: 1-1827864-4
  - Receptacle contact
    - 1827586-2: AWG28 to 30 (Hand tool: 1762952-1)
    - 1827587-2: AWG22 to 28 (Hand tool: 1762846-1)
    - 1827588-2: AWG22 to 28 (Hand tool: 1762950-1)
    - 1827589-2: AWG18 to 22 (Hand tool: 1762625-1)

## Accessory

### Mounting Bracket HE9Z-GH1 (for hanging the switch)

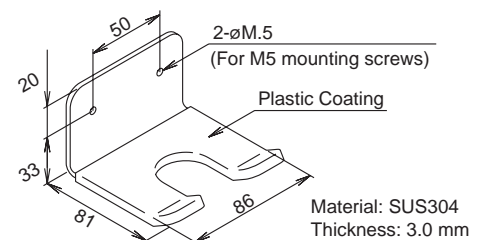

Note: Available for HE1G/HE1G-L/HE9Z-GSH51 only.



# HE2G Grip Style Three-position Enabling Switches

## New compact, light-weight grip style enabling switch provides a comfortable hold

- An HE2B enabling switch, compliant with IEC/EN60947-5-8, is installed.
- Equipped with different control units for various use.
- Choice of wire-saving internal connectors or solder terminal connectors.
- The curved grip and small-size makes operation comfortable. The light-weight (approx. 140g, HE2G-21SH) and compact size is suitable for operators with small hands and for use in tight working environments.
- The operating force required to shift from position 1 (contact OFF) to position 2 (contact ON) is reduced by 50% compared with IDEC's HE1G grip style enabling switch. Less operating force ensures worry-free operation.
- Tactile clicking feedback allows easy recognition of switch operation when shifting from position 1 (contact OFF) to position 2 (contact ON).
- Dual enabling contacts with a separate actuator for each contact is IDEC's original design. This ensures a higher safety level. Disparity detection of category 4 (ISO 13849-1) can be achieved by using this switch with a safety relay module or a safety controller.



## HE2G

3-Position Switch	Monitor Switch	Contact Configuration				Rubber Boot Material / Color	Wiring Style	Part No.	
		Additional Control Units (Note 1)							
		Emergency Stop Switch	Control Unit (A)	Control Unit (B)	Pilot Switch (green) (C)				
2 contacts	With (1NC)	Without				Silicon Rubber / (Yellow) (Note 2)	Solder Terminal	<b>HE2G-21SH</b>	
						NBR/PVC Polyblend / (Gray) (Note 3)	Internal Connector	<b>HE2G-21SC</b>	
							Solder Terminal	<b>HE2G-21SH-1N</b>	
		With (2NC)	Without		Without	Silicon Rubber / (Yellow) (Note 2)	Internal Connector	<b>HE2G-21SC-1N</b>	
		Without			With		Solder Terminal	<b>HE2G-21SHE</b>	
		With (2NC)	Momentary Pushbutton (DPDT)	Momentary Pushbutton (DPDT)	Without		Solder Terminal	<b>HE2G-21SHE-P-0</b>	
							Key Selector Switch (DPDT)	Solder Terminal	<b>HE2G-21SH-L-L</b>
							Without	Internal Connector	<b>HE2G-21SHE-L-L</b>
							Without	Solder Terminal	<b>HE2G-21SHE-L-K</b>
							Without	Internal Connector	<b>HE2G-21SCE-L-L</b>
				Without	Solder Terminal		<b>HE2G-21SCE-L-K</b>		
				Without	Internal Connector		<b>HE2G-21SCE-L-K</b>		

Note 1: Additional control units installed on the HE2G are as follows:

Emergency Stop Switch: XA1E-BV3U02R

Momentary Pushbutton: AB6M-M2PLW

Key Selector Switch: AS6M-2KT2PA Pilot Light: UP9P-2498G

Note 2: Silicon rubber: Can be used in general factories. Remains flexible in cold temperatures. Suitable in applications with a wide operating temperature range.

Note 3: NBR/PVC polyblend: Oil-proof. Suitable for environments subjected to machine oil and painting robots where silicon rubber cannot be used.

## Additional Control Unit Layout

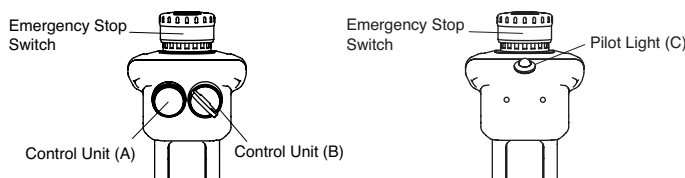

# HE2G Grip Style Three-position Enabling Switches

## Contact Ratings

Rated Insulation Voltage (Ui)		250V (momentary pushbutton and key selector: 125V) / 30V (with pilot light)					
Rated Thermal Current (Ith)		3A (emergency stop switch: 5A)*					
Rated Voltage (Ue)		30V	125V	250V			
Rated Current	Grip Style Enabling Switch	AC	Resistive Load (AC-12)	—	1A	0.5A	
			Inductive Load (AC-15)	—	0.7A	0.5A	
		DC	Resistive Load (DC-12)	1A	0.2A	—	
			Inductive Load (DC-13)	0.7A	0.1A	—	
		AC	Resistive Load (AC-12)	—	2A	1A	
			Inductive Load (AC-15)	—	1A	0.5A	
	DC	Resistive Load (DC-12)	2A	0.4A	0.2A		
		Inductive Load (DC-13)	1A	0.22A	0.1A		
	Control Unit	Emergency Stop Switch XA1E-BV3U02 (Terminal No.1-2/ A1-B1, 1-2/A2-B2)	AC	Resistive Load (AC-12)	—	5A	3A
				Inductive Load (AC-15)	—	3A	1.5A
		DC	Resistive Load (DC-12)	2A	0.4A	0.2A	
			Inductive Load (DC-13)	1A	0.22A	0.1A	
AC		Resistive Load (AC-12)	—	0.5A	—		
		Inductive Load (AC-15)	—	0.3A	—		
DC	Resistive Load (DC-12)	1A	0.2A	—			
	Inductive Load (DC-13)	0.7A	0.1A	—			
UP9 Pilot Light UP9P-2498G (Terminal No. +, -)		Rated operating voltage: 24V DC ±10% Rated current: 15mA					

Note: Minimum applicable load (reference value): 3V AC/DC, 5 mA  
(Applicable range is subject to the operating conditions and load.)

\*Operating temperature for internal connectors:

–25°C min., 40°C max. 2.5A (12 to 19 poles), 2A (20 to 22 poles)

40°C min., 50°C max. 2.5A (8 to 12 poles), 2A (13 to 22 poles)

50°C min., 60°C max. 2.5A (6, 7 poles), 2A (8 to 13 poles), 1.5A (14 to 22 poles)

## Specifications

Applicable Standards	UL508 (UL approval pending) CSA C22.2, No. 14 (c-UL approval pending) IEC/EN 60947-5-1 (TÜV) GS-ET-22 (TÜV approval)
Applicable Standards for Use	ISO 12100-1, -2 IEC 60204-1/EN 60204-1 ISO 11161 / prEN11161 ISO 10218 / EN 775 ANSI/RIA R15.06 ANSI B11.19
Operating Temperature	Silicon rubber boot: –25 to 60°C (no freezing) NBR/PVC Polyblend rubber boot: –10 to 60°C (no freezing)
Relative Humidity	45 to 85% (no condensation)
Storage Temperature	–40 to +80°C (no freezing)
Pollution Degree	3
Contact Resistance	50 mΩ maximum (initial value)
Insulation Resistance	Between live and dead metal parts: 100 MΩ minimum (500V DC megger) Between terminals of different pole: 100 MΩ minimum (500V DC megger)
Impulse Withstand Voltage	(Solder terminal) Grip style enabling switch/emergency stop switch: 2.5 kV Momentary pushbutton/key selector switch: 1.5 kV Pilot light: 500V AC, 1 minute (between live and dead parts) (Internal connector) Grip style enabling switch/emergency stop switch/ momentary pushbutton/key selector switch: 1.5 kV
Electric Shock Protection Class	Class II (IEC 61140) (With pilot light: class III)
Operating Frequency	1,200 operations per hour
Mechanical Durability	Position 1 → 2 → 1: 1,000,000 operations minimum Position 1 → 2 → 3 → 1: 100,000 operations minimum
Electrical Durability	100,000 operations minimum (rated load) 1,000,000 operations minimum (24V AC/DC, 100 mA)
Shock Resistance	Operating extremes: 150 m/s <sup>2</sup> Damage limits: 1,000 m/s <sup>2</sup>
Vibration Resistance	Operating extremes: 5 to 55 Hz, amplitude 0.5 mm minimum Damage limits: 16.7 Hz, amplitude 1.5 mm minimum
Applicable Wire	Solder terminal: 0.5 mm <sup>2</sup> maximum Internal connector: 0.05 to 0.86 mm <sup>2</sup> (AWG18 to 30)
Applicable Wire Size	Solder terminal: 0.5 mm <sup>2</sup> Internal connector: 0.05 to 0.86 mm <sup>2</sup> (AWG18 to 30) (AWG22 between switch and connector)
Applicable Cable	Outside diameter: ø4.5 to 10 mm
Conduit Port Size	M16 (cable gland is supplied)
Terminal Tensile Strength	20N minimum
Degree of Protection	With control unit: IP67/IP66 (IEC 60529) Without control unit: IP65 (IEC 60529)
Conditional Short-circuit Current	50A (250V) (Use 250V/10A fast-blow fuse for short circuit protection.)
Direct Opening Force	60N minimum (monitor switch)
Operator Strength	500N minimum (when pressing the entire button surface)
Free Fall	1.0m 1 fall (IEC 60068-2-32 compliant)
Weight (approx.)	HE2G-21SH: 140g HE2G-21SH-P-0/-21SC: 145g HE2G-21SHE/-21SC-P-0: 150g HE2G-21SH-L-L/-21SHE-P-0/-21SCE: 155g HE2G-21SH-L-K/-21SCE-P-0: 160g HE2G-21SHE-L-L/-21SC-L-L: 165g HE2G-21SHE-L-K/-21SC-L-K: 170g HE2G-21SCE-L-L: 175g HE2G-21SCE-L-K: 180g

# HE2G Grip Style Three-position Enabling Switches

## Operation Characteristics

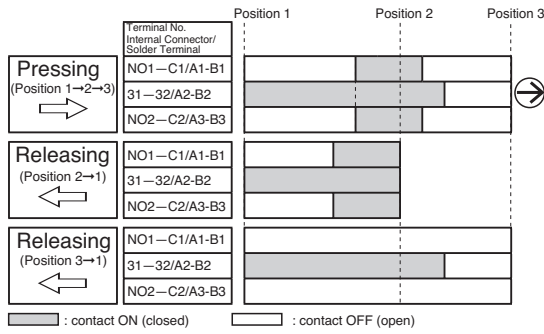

- Terminals NO1-C1/A1-B1, NO2-C2/A3-B3 are outputs of the 3-position enabling switch.
- The above operation characteristics show when the center of the grip style enabling switch button is pressed. Because two contacts are designed to operate independently, pressing the edge of the button turns on one contact earlier than the other contact, causing a delay in operation. To avoid this, always press the center of the button.

## Dimensions

### HE2G-21SH/HE2G-21SC

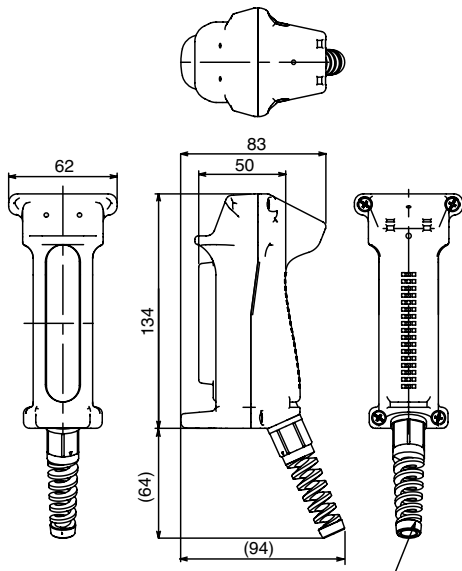

Cable Gland (supplied with grip style enabling switch)  
Part No.: SKINTOP BS-M16 × 1.5 (LAPP)

All dimensions in mm.

### Internal Connector

Cable side connector:  
Tyco Electronics D-1200D Series

- Receptacle: 1-1827864-□
- Receptacle contact
  - 1827586-2: AWG28 to 30 (Hand tool: 1762952-1)
  - 1827587-2: AWG22 to 28 (Hand tool: 1762846-1)
  - 1827588-2: AWG22 to 28 (Hand tool: 1762950-1)
  - 1827589-2: AWG18 to 22 (Hand tool: 1762625-1)

Specify 2 or 3 in place of □.

- 2: 4-pin connector
- 3: 6-pin connector

The customer needs to purchase the connector separately.

## Contact Arrangement (Internal Connector)

### Internal Connector Pin No.

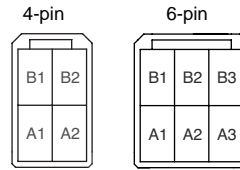

- Emergency stop switch
- 3-position switch
- Momentary pushbutton
- Key selector switch

3-position switch /control unit side connector:  
Tyco Electronics D-1200D Series  
Tab housing: 1-1903130-2 (4-pin connector)  
1-1903130-3 (6-pin connector)  
Tab contact: 19303116-2

### Terminal Arrangement (TOP VIEW)

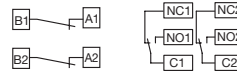

- Emergency stop switch
- Momentary pushbutton
- Key selector switch

### 6-Pin Connector Allotment Table

Internal Connector Pin No.	Momentary pushbutton Key selector switch
A1	C2
A2	NO2
A3	NC2
B1	C1
B2	NO1
B3	NC1

- For signal of the 3-position switch, see "Operation Characteristics".
- For solder terminal type terminal arrangement of each control unit, see each catalog.

# Three-position Enabling Switches/Grip Style Three-position Enabling Switches



## Safety Precautions

- The enabling switches have been designed for industrial purposes. Use for residential, commercial, or lighting purposes may cause unwanted electromagnetic disturbances in which case the user may be required to take adequate mitigation measures.
- In order to avoid electric shock or fire, turn the power off before installation, removal, wiring, maintenance, or inspection of the enabling switch.
- Do not disassemble or modify the enabling switches. Also do not disable the enabling function, otherwise failure or accident will occur.
- Provide sufficient strength to the mounting panel. Insufficient strength of the mounting panel or excessive operating force may damage the enabling switch, resulting in electric shock or fire.
- Use wires of the proper size to meet voltage and current requirements, and solder the wires correctly according to the wiring instruction described below. If soldering is incomplete, the wire may heat during operation, causing a fire hazard.
- When using the enabling switch in a safety related part of a control system, use the enabling switch properly in accordance with the safety standards and regulations of the actual machine, system, and application, of the country or region where the enabling switch is used. Also, perform a risk assessment before using the enabling switch.
- Do not disable the safety function of the enabling switch by using tape, elastic band, or by disfiguring the rubber boot, otherwise the loss of enabling switch function may cause serious accidents.

## Instructions

### Installation Instructions

#### HE2B/HE6B Enabling Switch with Rubber Boot

- The ridge on the bottom of rubber boot serves as a seal, and waterproof characteristics are attained when the ridge is tightly pressed to the mounting panel. When the mounting panel is bent and the ridge cannot be pressed to the panel, add a reinforcing rib to secure the boot to the mounting panel.
- The edge of rubber boot may stick out if excessive force is applied on the rubber boot. When such event is anticipated, it is recommended to embed the rubber boot in the mounting panel as shown in the figure below.

#### HE2B

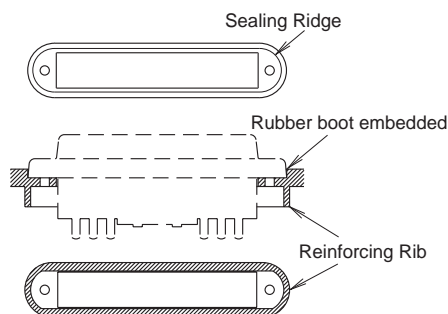

#### HE6B

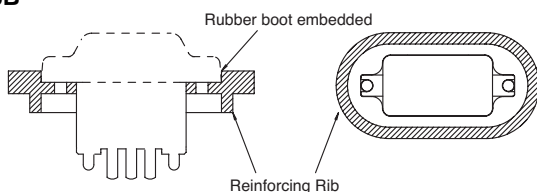

#### HE2B/HE3B/HE5B/HE6B Enabling Switch with Rubber Boot

- When an enabling switch with rubber boot is mounted in a hermetically-sealed control box, a large change in internal air pressure may cause the rubber boot to inflate and deflate, affecting the performance of the enabling switch. Check periodically to make sure that the enabling switch operates correctly.

#### HE3B Enabling Switch with Rubber Boot

- If the mounting panel is deformed, waterproof characteristics of the enabling switch with rubber boot cannot be achieved. Keep sufficient strength on the mounting panel.
- The rubber boot has a projection for positioning the enabling switch onto the mounting panel. To maintain waterproof characteristics of the switch, do not drill through the anti-rotation hole in the mounting panel. When not providing the hole, remove the anti-rotation projection from the rubber boot. When removing the projection, ensure not to make a hole in the rubber boot.

- Secure the flange part when tightening the locking ring so that the enabling switch does not rotate. When the enabling switch may rotate during operation, it is recommended to embed the switch in the mounting panel as shown below.

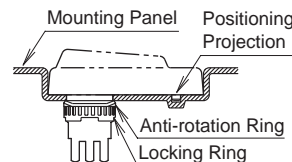

#### HE5B Enabling Switch with Rubber Boot

- If the mounting panel is deformed when mounting an enabling switch with rubber boot, the normal waterproof characteristics cannot be assured. Keep sufficient strength on the mounting panel.
- Do not press the rubber boot with excessive pressure in an inappropriate direction, otherwise the waterproof function can be damaged.

### Wiring Instructions

#### HE1B/HE2B/HE3B/HE5B/HE6B Enabling Switch

- Applicable wire size: 0.5 mm<sup>2</sup> maximum × 1 pc.
- Solder the terminal at a temperature of 310 to 350°C within 3 seconds using a soldering iron. Sn-Ag-Cu type is recommended when using lead-free solder. Do not use flow or dip soldering.
- When soldering, take care not to touch the enabling switch with the soldering iron. Also ensure that no tensile force is applied to the terminal. Do not bend the terminal or apply excessive force to the terminal.
- Use non-corrosive liquid rosin as soldering flux.

#### HE9Z-GSH51 Grip Style Enabling Switch Housing

##### Recommended Tightening Torque

Parts for tightening		Torque
A	Head and body	1.0 ± 0.2 N·m
B	Body and cable gland	3.0 ± 0.3 N·m
C	Cable gland	3.0 ± 0.3 N·m

Note: The recommended tightening torques of B and C are for the supplied cable gland. When using another cable gland, refer to the tightening torque of the cable gland used.

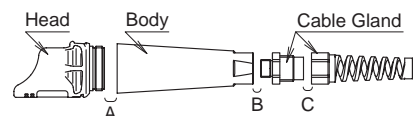

# Three-position Enabling Switches/Grip Style Three-position Enabling Switches

## HE1G/HE1G-L Grip Style Enabling Switch

### Wire Length inside the Grip Style Enabling Switch

	Terminal No. 1-4	Terminal No. 5-8
Wire length L1, L2 (mm)	L1 = 40 mm	L2 = 27 mm
Wire stripping length L3 (mm)	L3 = 6 mm	

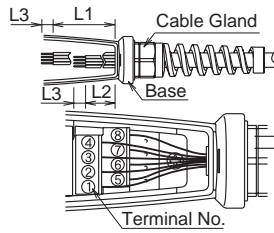

### Applicable Wire Size

<Direct wiring>

0.14 to 1.5 mm<sup>2</sup> (one wire per terminal)

Note: When using stranded wire, make sure that adjoining terminals are not short-circuited by frayed wires. Also, do not solder the wires to avoid frayed wires.

<Ferrules>

Recommended ferrules (Phoenix Contact)

Part No.	Applicable Wire
AI 0,5-8 WH	0.34 to 0.5 mm <sup>2</sup>
AI 0,75-8 GY	0.5 to 0.75 mm <sup>2</sup>
AI 1,0-8 RD	0.75 to 1.0 mm <sup>2</sup>
AI 1,5-8 BK	1.0 to 1.5 mm <sup>2</sup>

Crimping tool: CRIMPFOX UD6

### Recommended Tightening Torque

Parts for Tightening		Torque
A	Rubber boot and the base (M4 screw x 3)	1.2 ± 0.1 N·m
B	Connector and grip style enabling switch	4.0 ± 0.3 N·m
C	Connector and connector	4.0 ± 0.3 N·m
D	Terminal screw (M3 screw x 8)	0.5 to 0.6 N·m
E	Do not remove screws	—

The torque of screws B and C in the table above are values when the recommended connector is used. When using another connector, refer to the specifications of the connector used.

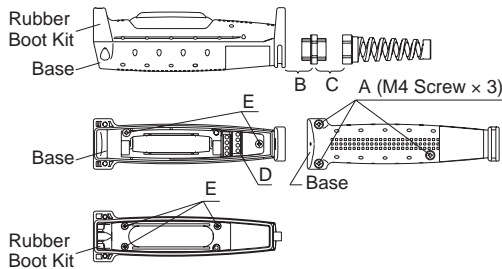

## HE1G-L (Internal Connector)

### Wire Length inside the Switch

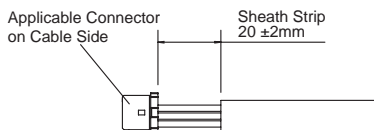

### Applicable Wire Size

• 0.05 to 0.86mm<sup>2</sup> (AWG18 to 30): Check the compliance with receptacle and contact.

Tool: 1762846-1 (manual tool)

Observe the requirements of GS-ET-22: 2003, 4.2.6 for wiring.

Note: When using stranded wires, make sure that loose wires do not cause short circuit. Also, do not solder the terminals to prevent loose wires. Use copper wire of 60°C or 75°C temperature rating in order to comply with UL508. Observe the requirements of GS-ET-22: 2003, 4.2.6 for wiring.

### Recommended Tightening Torque

Parts for Tightening		Torque
A	Base and rubber kit (M4 screw x 3)	1.1 to 1.3 N·m
B	Cable gland and grip style enabling switch	3.7 to 4.3 N·m
C	Cable gland	3.7 to 4.3 N·m
D	Do not touch	—

Note: The recommended tightening torques of B and C are for the supplied cable gland. When using another cable gland, refer to the tightening torque of the cable gland used.

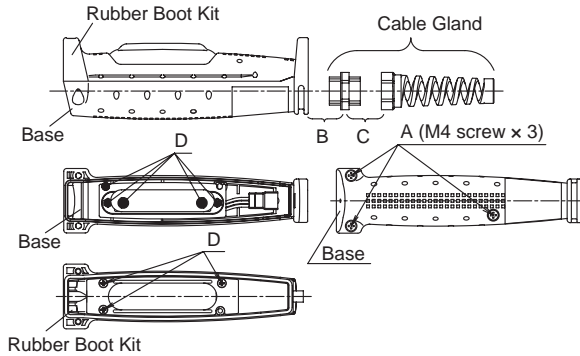

## HE2G (Solder Terminal)

### Wire Length inside the Switch

	Grip Style Enabling Switch						Momentary Pushbutton/Key Selector Switch		Emergency Stop Switch		Pilot Light				
	NO1	C1	11	12	31	32	NO2	C2	C	NO	NC	1	2	+	-
Wire stripping length L1 (mm)	40	45	50	60	50	60	85	80	120			110		115	
Wire stripping length L2 (mm)	L2=5mm														

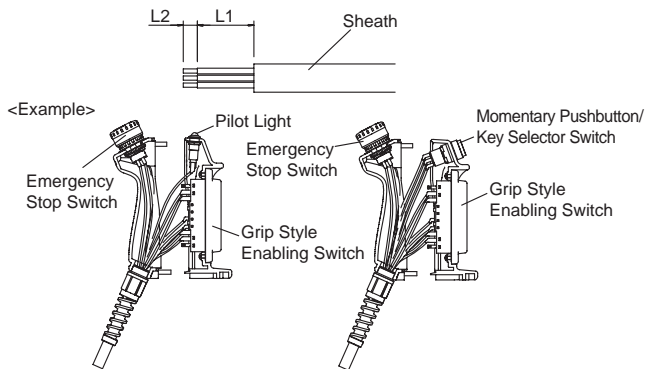

### Applicable Wire Size in Solder Terminal

0.5mm<sup>2</sup> maximum (Observe the requirements of IEC 60204-1 for wiring.)



# Three-position Enabling Switches/Grip Style Three-position Enabling Switches

## Recommended Tightening Torque

	Parts for tightening	Torque
A	Base and rubber kit (M4 screw x 4)	1.1 to 1.3 N·m
B	Cable gland and grip style enabling switch	2.7 to 3.3 N·m
C	Cable gland	2.7 to 3.3 N·m
D	HE2B Enabling Switch (M3 screws x 2) *	0.5 to 0.8 N·m

Note: The recommended tightening torques of B and C are for the supplied cable gland. When using another cable gland, refer to the tightening torque of the cable gland used.

\* For replacing HE2B enabling switch or rubber boot only

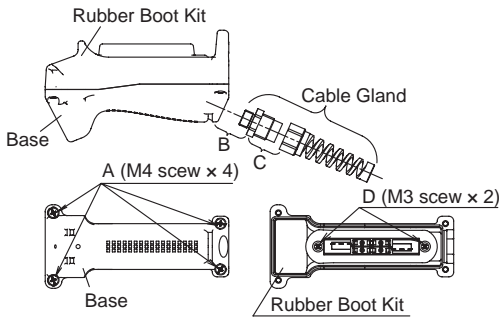

## HE2G (internal connector)

### Wire Length inside the Switch

	Grip Style Enabling Switch	Momentary Pushbutton/Key Selector Switch	Emergency Stop Switch
Wire stripping length L1 (mm)	20	60	75

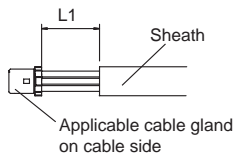

<Example>

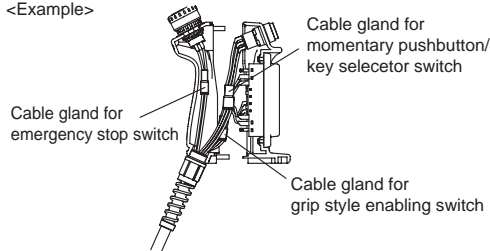

### Applicable wire size for the cable gland on cable side

- 0.05 to 0.86mm<sup>2</sup> (AWG18 to 30): Check the compliance with receptacle and contact.

Tool: 1762846-1 (manual tool)

Note: When using stranded wires, make sure that loose wires do not cause short circuit. Also, do not solder the terminals to prevent loose wires. Use copper wire of 60°C or 75°C temperature rating in order to comply with UL508. Observe the requirements of GS-ET-22: 2003, 4.2.6 for wiring.

## Operating Instructions

### HE2B/HE3B/HE5B/HE6B/HE1G/HE1G-L/HE2G

- To achieve a high level of safety, connect the two contacts of the 3-position switch to a disparity detection circuit (e.g., safety relay module) (ISO 13849-1, EN 954-1).
- Because two contacts are designed to operate independently, pressing the edge of a button turns on one contact earlier than the other contact, causing a delay in operation. To avoid this, always press the center of the button.

### HE1B/HE2B/HE3B/HE5B/HE6B/HE1G/HE1G-L/HE2G

- 3-position enabling switches output ON signals in position 2. Systems must be designed to enable machine operation when the 3-position enabling switch is in position 2 only.
- Perform a risk assessment in actual applications as strong force may be applied to the switch when depressed to position 3.
- Perform a risk assessment for the shape and structure of the part where the enabling switch is installed, to prevent unintended operation of the enabling switch. For example, an enabling switch protruding from the teach pendant may result in an unintended operation of the enabling switch.
- Strong force may be applied to a 3-position enabling switch when pressed to position 3. Provide sufficient strength to the part where 3-position enabling switches will be installed.

# Actuator with Plastic Holder

## HS5 series interlock switches detect the installation/removal of grip style enabling switches.

- The actuator with plastic holder for the HS5 series interlock switches can be installed onto the HE1G/HE1G-L/HE2G grip style enabling switches easily using the two mounting screws supplied with the actuator.
- Inserting the actuator on the grip style enabling switch into the entry slot of HS5D/HS5B/HS5E/HS5E-K interlock switch, the grip style enabling switch can be retained firmly in position.
- Using with HS5E/HS5E-K interlock switches prevent unauthorized removal of grip style enabling switches.
- Easy switching by removing/installing the grip style enabling switches can be achieved by designing the circuit to initiate automatic or manual operation when the interlock switch is installed or removed, respectively.

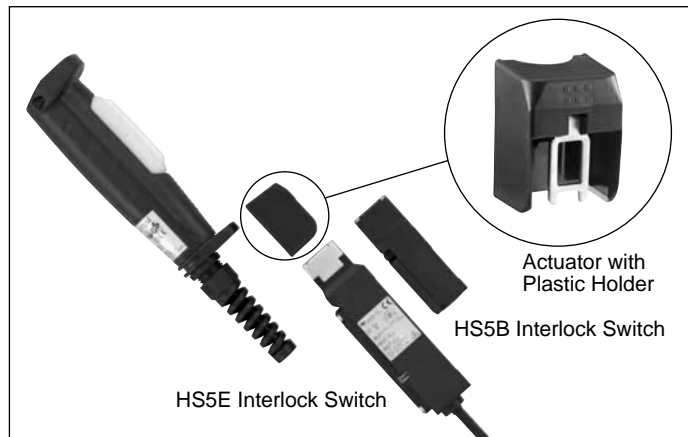

Description	Part No.
Actuator with plastic holder for HE1G/HE1G-L/HE2G	<b>HE9Z-GP15</b>

Note: The HE1G/HE1G-L/HE2G grip style enabling switches and HS5 series interlock switches are ordered separately.

## Specifications

Applicable Model	HE1G/HE1G-L/HE2G Grip Style Enabling Switch HS5D/HS5B/HS5E/HS5E-K Interlock Switch
Mechanical Durability	10,000 operations
Weight (approx.)	30g

Note: Refer to the specifications of HE1G/HE1G-L/HE2G grip style enabling switches and HS5D/HS5B/HS5E/HS5E-K interlock switches.

## Dimensions

When used with an HE1G/HE1G-L and HS5D/HS5B

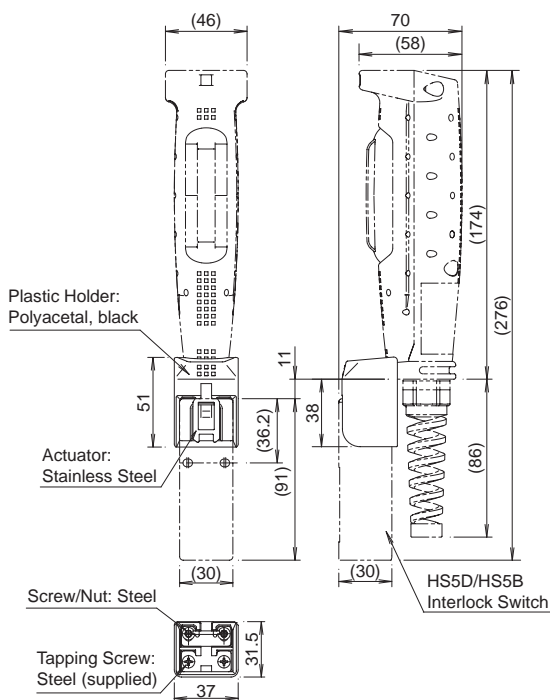

When used with an HE1G/HE1G-L and HS5E/HS5E-K

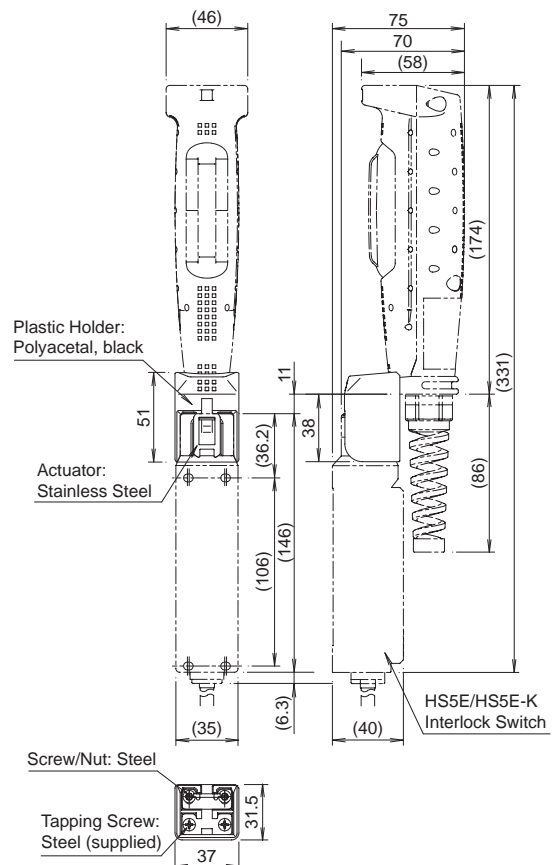

All dimensions in mm.

# Actuator with Plastic Holder

## Instructions

### Mounting

- ① The HE9Z-GP15 and the HE1G/HE1G-L are installed as shown in the following figure.

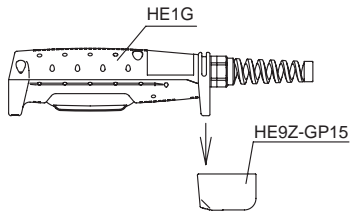

- ② Secure the actuator using the attached two screws in the direction of the arrow as shown in the following figure.

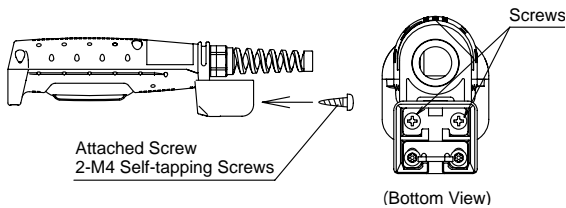

- Using the attached screws (M4 self-tapping screw x 2), secure the HE9Z-GP15 to the grip style enabling switch. Recommended tightening torque:  $1.0 \pm 0.1$  N·m. Do not use excessive force to tighten the HE9Z-GP15 onto the switch, otherwise the mounting holes will become deformed and the HE9Z-GP15 cannot be secured. Prevent the screws from loosening by applying epoxy. (Recommended: LOCTITE 425, ThreeBond 1401)

### Precautions for Installation

- When using the HE9Z-GP15 for safety-related equipment in a control system, refer to safety standards and regulations in each country and region to make sure of correct operation. Also, perform a risk assessment to ensure safety before starting operation of the machine.
- Read the instruction sheets for both the grip style enabling switch and interlock switch to be used.
- Insert the HE9Z-GP15 in the direction shown in the following figure only. Do not insert from any other direction. Also, do not use the slot plug attached to the interlock switch.

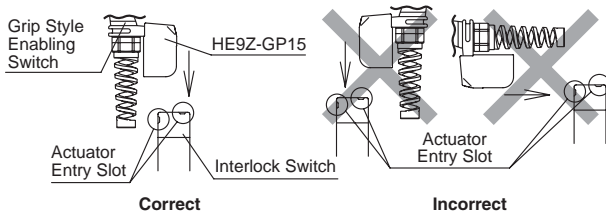

- See below for vertical installation. Do not install in any other direction. Also, make sure that the mounting surface is provided for the entire area of the grip style enabling switch, so that the switch does not tilt as shown below. Otherwise the HE9Z-GP15 actuator will be deformed.

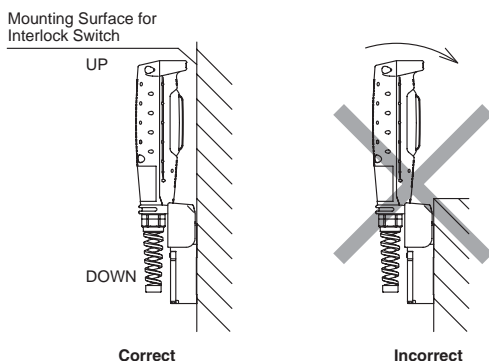

- Do not install the grip style enabling switch and the interlock switch in an area subjected to vibration. Excessive vibration may cause malfunction of the switch contacts of the grip style enabling switch. Also, exposure to vibration for a long period of time can cause scratching and deformation of plastic parts.
- When installing or removing the grip style enabling switch, do not use excessive force in any direction other than shown in the following figure. Otherwise the HE9Z-GP15 actuator can become deformed or damaged.

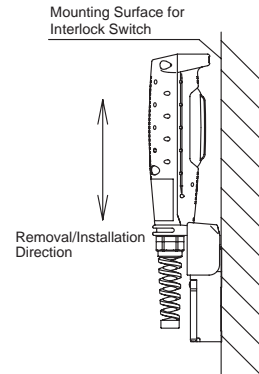

- Make sure that the HE9Z-GP15 actuator is inserted completely into the interlock switch. Avoid any foreign objects between the actuator and interlock switch as they may interfere with the plastic spring, resulting in possible damage to the actuator.

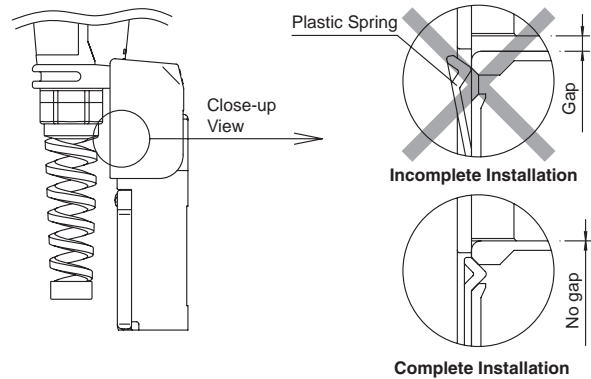

- When manually unlocking the HS5E interlock switch attached to the grip style enabling switch, bend the spiral part of the connector slightly to be able to access the manual unlock key.

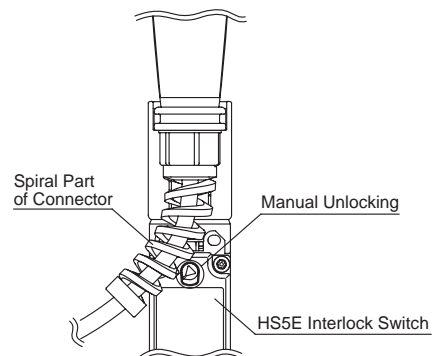

- Do not apply excessive shocks to the HE9Z-GP15 when attached to the interlock switch, otherwise the actuator may be removed from the interlock switch. Also excessive shocks may result in damage or failure of the interlock switch.
- When the plastic part of the HE9Z-GP15 or the actuator is damaged or deformed, stop using immediately.
- The HE9Z-GP15 is used for HE1G/HE1G-L/HE2G grip style enabling switch and HS5D/HS5B/HS5E/HS5E-K interlock switches only. Do not use the HE9Z-GP15 for other products.
- Do not modify or disassemble the HE9Z-GP15.

Specifications and other descriptions in this catalog are subject to change without notice.



## IDEC CORPORATION

7-31, Nishi-Miyahara 1-Chome, Yodogawa-ku, Osaka 532-8550, Japan  
Tel: +81-6-6398-2571, Fax: +81-6-6392-9731  
E-mail: marketing@idec.co.jp

### IDEC CORPORATION (USA)

1175 Elko Drive  
Sunnyvale, CA 94089-2209, USA  
Tel: +1-408-747-0550 / (800) 262-IDEAC (4332)  
Fax: +1-408-744-9055 / (800) 635-6246  
E-mail: opencontact@idec.com

### IDEC CANADA LIMITED

3155 Pepper Mill Court, Unit 4  
Mississauga, Ontario, L5L 4X7, Canada  
Tel: +1-905-890-8561, Toll Free: (888) 317-4332  
Fax: +1-905-890-8562  
E-mail: sales@ca.idec.com

### IDEC AUSTRALIA PTY. LTD.

Unit 17, 104 Ferntree Gully Road,  
Oakleigh, Victoria 3166, Australia  
Tel: +61-3-8523-5900, Toll Free: 1800-68-4332  
Fax: +61-3-8523-5999  
E-mail: sales@au.idec.com

### IDEC ELECTRONICS LIMITED

Unit 2, Beechwood, Chineham Business Park,  
Basingstoke, Hampshire RG24 8WA, UK  
Tel: +44-1256-321000, Fax: +44-1256-327755  
E-mail: sales@uk.idec.com

### IDEC ELEKTROTECHNIK GmbH

Wendenstrasse 331, 20537 Hamburg, Germany  
Tel: +49-40-25 30 54 - 0, Fax: +49-40-25 30 54 - 24  
E-mail: service@idec.de

### IDEC (SHANGHAI) CORPORATION

Room 701-702 Chong Hing Finance Center,  
No. 288 Nanjing Road West, Shanghai 200003, PRC  
Tel: +86-21-6135-1515  
Fax: +86-21-6135-6225 / +86-21-6135-6226  
E-mail: idec@cn.idec.com

### IDEC (BEIJING) CORPORATION

Room 211B, Tower B, The Grand Pacific Building,  
8A Guanghua Road, Chaoyang District,  
Beijing 100026, PRC  
Tel: +86-10-6581-6131, Fax: +86-10-6581-5119

### IDEC (SHENZHEN) CORPORATION

Unit AB-3B2, Tian Xiang Building, Tian'an Cyber Park,  
Fu Tian District, Shenzhen, Guang Dong 518040, PRC  
Tel: +86-755-8356-2977, Fax: +86-755-8356-2944

### IDEC IZUMI (H.K.) CO., LTD.

Units 11-15, Level 27, Tower 1,  
Millennium City 1, 388 Kwun Tong Road,  
Kwun Tong, Kowloon, Hong Kong  
Tel: +852-2803-8989, Fax: +852-2565-0171  
E-mail: info@hk.idec.com

### IDEC TAIWAN CORPORATION

8F-1, No. 79, Hsin Tai Wu Road, Sec. 1,  
Hsi-Chih District, New Taipei City, Taiwan  
Tel: +886-2-2698-3929, Fax: +886-2-2698-3931  
E-mail: service@tw.idec.com

### IDEC IZUMI ASIA PTE. LTD.

No. 31, Tannery Lane #05-01,  
HB Centre 2, Singapore 347788  
Tel: +65-6746-1155, Fax: +65-6844-5995  
E-mail: info@sg.idec.com