

**ROBO Cylinder®
with Battery-less Absolute Encoder**

Cleanroom Type

RCP5 RCP5CR

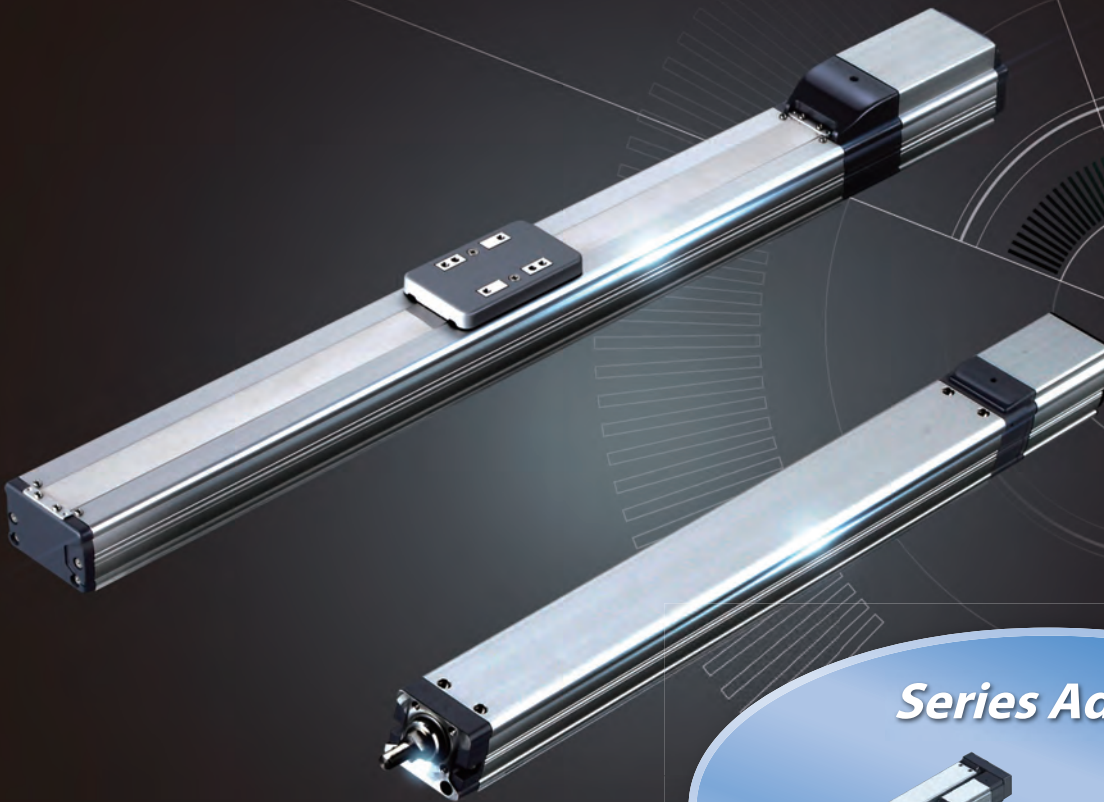

**Battery-less
Absolute**

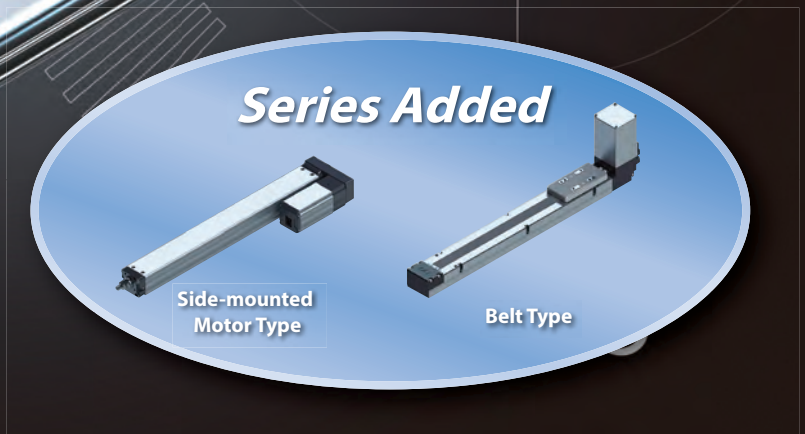

Introducing the RCP5 Series, powered by a battery-less actuator, with the convenience of an absolute encoder and the cost and simplicity of an incremental encoder

The innovative battery-less absolute encoder (patent pending) operates through a combination of gears to read the rotational position data. This eliminates the need for the battery that is normally required for a conventional absolute encoder. This means there is no longer a need for battery replacement, with the associated costs and adjustments.

Slider Type



Rod Type

Radial Cylinder

Can carry radial loads.

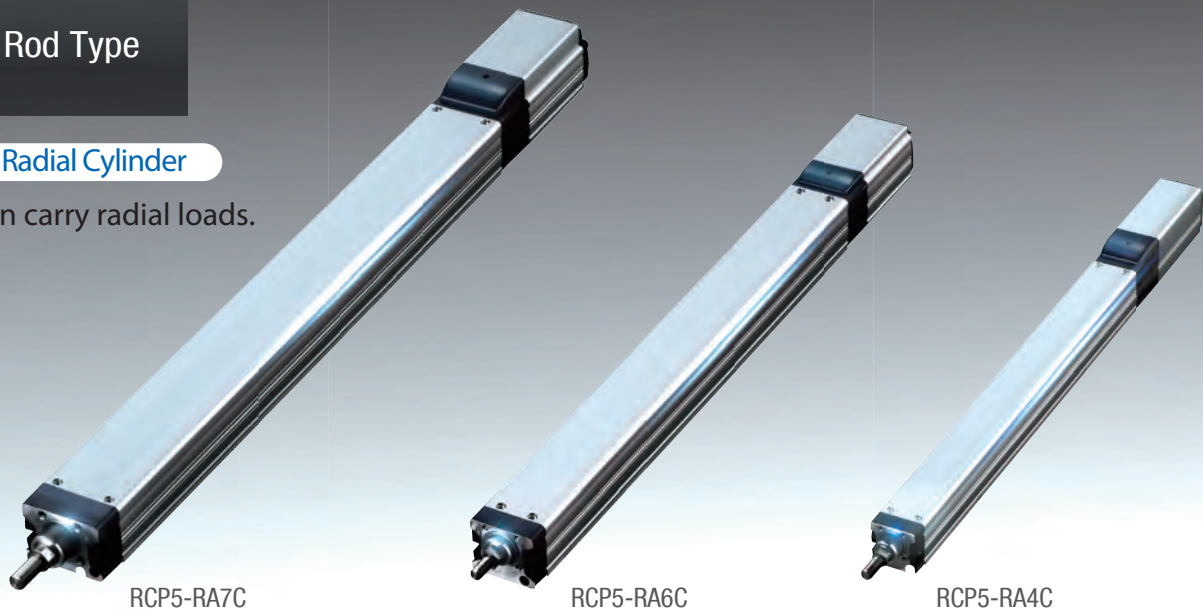

Added to the Series: Side-mounted Motor and Belt Types

Compared to the existing model (RCP2-BA), the belt type is;

- Available with a maximum stroke of 2,600mm
- Equipped with a standard stainless steel dust cover
- 1.5 times greater maximum speed and maximum payload

Side-mounted
Motor Type

Belt Type

Slider Type

Rod Type (Radial Cylinder)

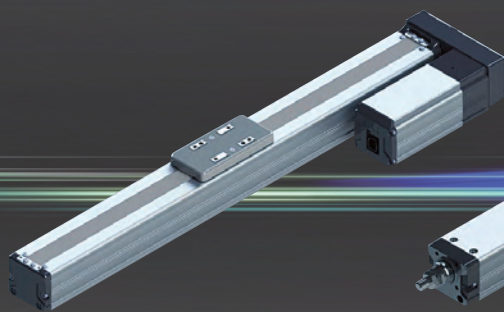

RCP5-SA4R/SA6R/SA7R

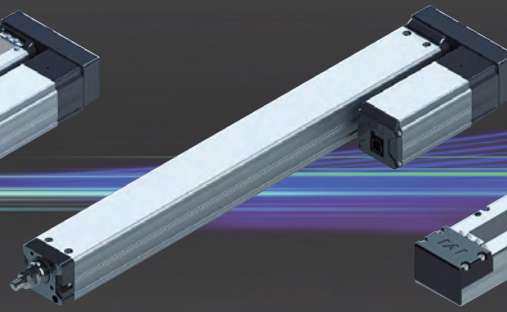

RCP5-RA4R/RA6R/RA7R

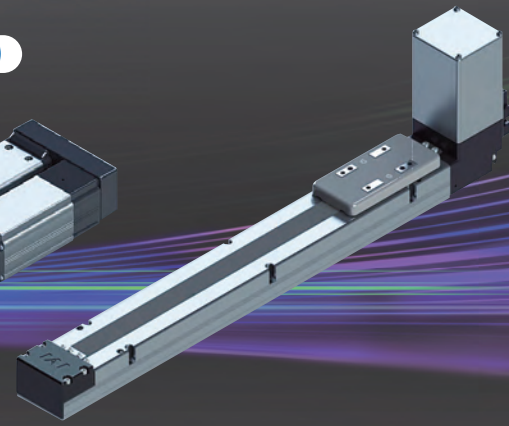

RCP5-BA4/BA6/BA7

Cleanroom
Type

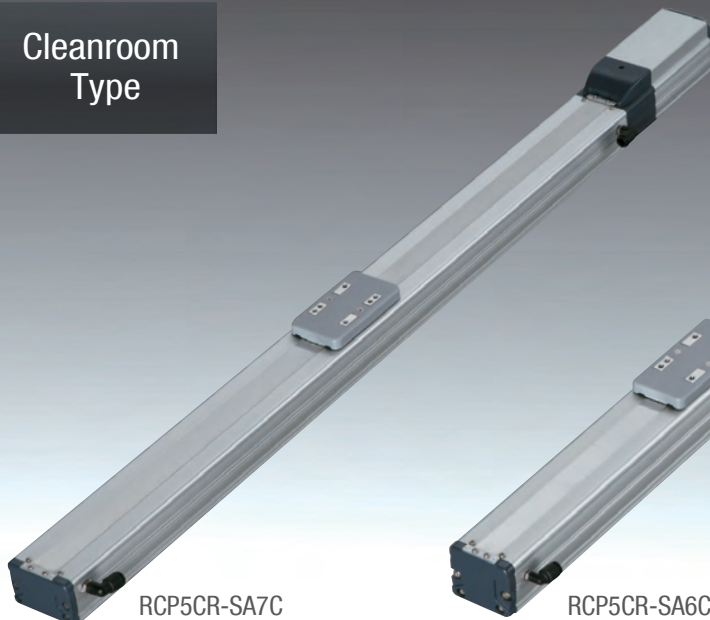

RCP5CR-SA7C

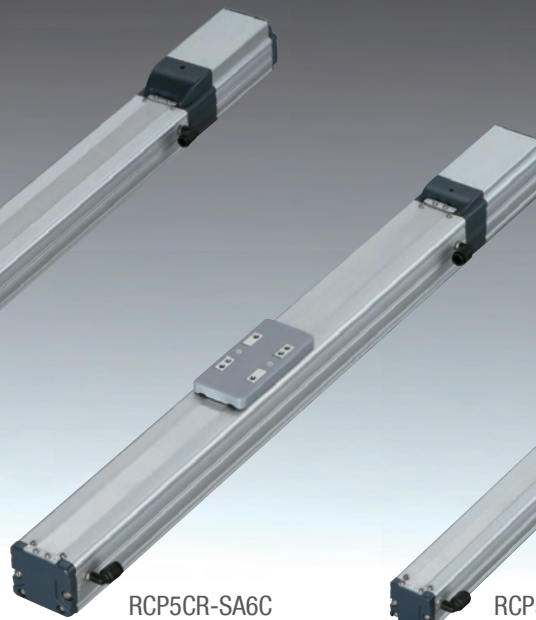

RCP5CR-SA6C

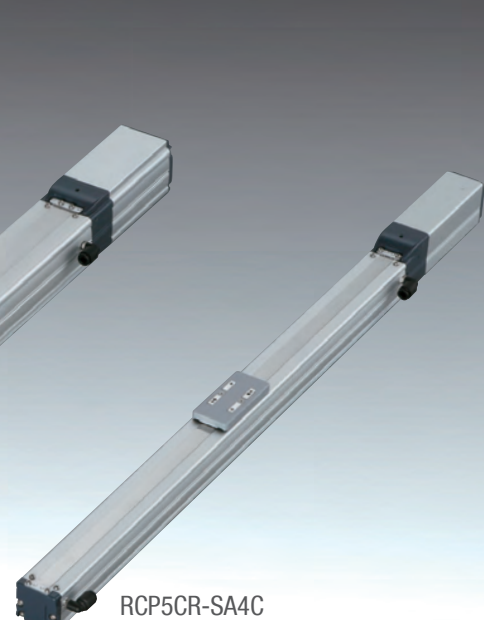

RCP5CR-SA4C

The ROBO Cylinder is Easy to Use!!!

Problem Solving

Manufacturing Site Problems and Solutions

Air Cylinder Problems

- 1 Reduced operation rate due to choco-tei caused by position switch failure or air pressure fluctuations
- 2 Cycle time cannot be shortened when sudden stops limit the operating speed.

Electric Actuator (Incremental Type) Problems

- 1 After an emergency stop is reset, there is a long delay before the actuator returns to its home position or for an adjustment

Electric Actuator (Absolute Type) Problems

- 1 Higher cost
- 2 Battery replacement time management is required
- 3 Battery replacement labor and cost



Electric Actuator Solutions (CT Effect)*

- 1 Choco-tei significantly reduced
- 2 Operating speeds are able to increase since there are no sudden stops

Absolute Type Solutions

- 1 Home return is not required

Battery-less Absolute Type Solutions

- 1 Battery is not required
- 2 Slider type offered at the same price as the incremental type in RCP4 Series

Problems solved with the RCP5 Series!





Battery-less
ABSOLUTE

* The "CT Effect" refers to the increase in production volume per unit of time, which enables "shorter cycle-times" and "reduced choco-tei", due to re-evaluating the configuration of the automated equipment.

The Battery-less Absolute Encoder

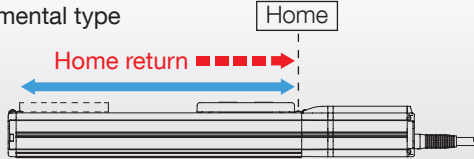
What is an absolute encoder?

<p>Incremental type</p> 	<p>Since position data is lost when the power is shut down, this type of encoder will not operate until it has established its home position.</p>
<p>Absolute type</p> 	<p>This type of encoder will maintain its position data even when the power is shut off, and will resume operating from its current position when the power is switched on.</p>

Advantages of an absolute encoder

Advantage 1:

Home return is not required, which means reduced amount of labor and time required for adjustment when starting up the device.

Advantage 2:

The amount of time required for adjustment after an emergency stop until operation resumes is reduced.

What is a battery-less absolute encoder?

The battery-less absolute encoder verifies its current position based on the linked gear positions. A conventional absolute encoder uses a battery to store its current position, but since the battery-less type has no need to store this data, the battery was eliminated.



Advantages of a battery-less absolute encoder

Advantage 1:

More economical with no cost associated with battery replacement.

Advantage 2:

Battery replacement management is no longer required. Labor for replacement work is also no longer required.

Advantage 3:

Battery installation space is not required.

Advantage 4:

Even if the cable between the controller and the actuator is replaced, operation will resume with no adjustments needed, since positioning data is read each time it operates.

Advantage 5:

No external sensor, such as a sensor to check the origin, is required since home return is not necessary.

Advantage 6:

IAI's slider type, even with the battery-less absolute encoder, is offered for the same price as the conventional incremental type in RCP4 series.

Service life of a battery-less absolute encoder

The mechanical configuration of the battery-less absolute encoder offers a service life that is approximately four times the actuator guide's standard rating. Furthermore, it can be used with a sense of security because it will output an error when a certain amount of wear in the gear section is detected.

The ROBO Cylinder is Easy to Use!!!

Feature **2**

1.5 Times Higher Maximum Speed and Double the Payload When Combined with a PowerCON®

Shorter cycle time significantly boosts the productivity of your system

The new controller (PowerCON) is equipped with the newly developed high-output driver (patent pending) and has achieved significantly higher speeds up to 1.5 times more than IAI's conventional models. In addition, the payload is as much as two times greater, which are astonishing improvements in specifications. Furthermore, due to the motor's torque improvement at increased rotations, maximum speeds are not reduced even when the payload is increased, and it has achieved performance equivalent to a higher-class model at a lower cost.

(*) The specific rates of improvement vary depending on the model.

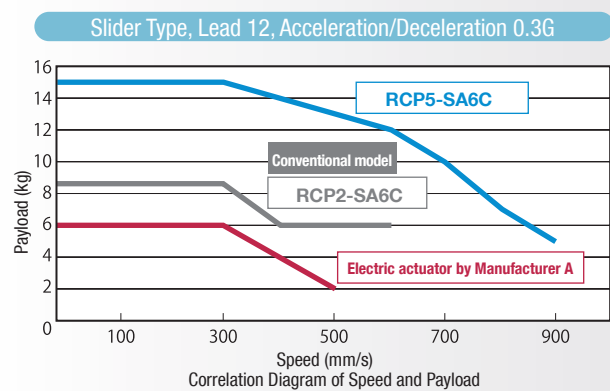

Multi-axis type is now available with a PowerCON

Since the MSEP Controller uses the PowerCON® specification, it has speeds up to 1.5 times higher and a payload of up to 2 times higher compared to the existing models, and can operate a maximum of four RCP5 axes at once. Also, if high-output capability is not used, maximum of eight axes is possible. In addition, the designated target location can be changed via the field network.

A Maximum of Four RCP5 Axes Can Be Operated at Once*

Compatible Field Networks



Feature

3

The Rod Type Can Carry Radial Loads.

The rod type <Radial Cylinder> with a built-in guide mechanism can carry radial loads over a long stroke of up to 800mm.

The rod type (Radial Cylinder) has a built-in ball circulating type linear guide mechanism, which allows it to carry radial loads and have a long stroke of up to 800mm. In addition, the actuator can support a radial load that is offset from the center of the rod.

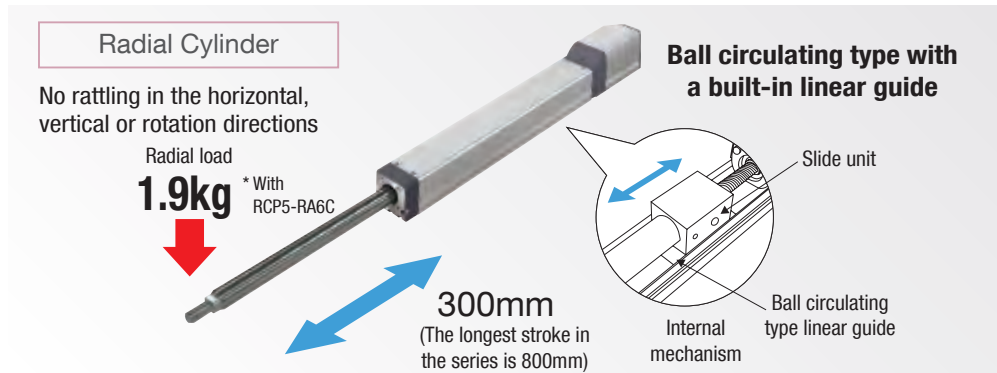

Usage example 1 When a guide mechanism is required in a tight space

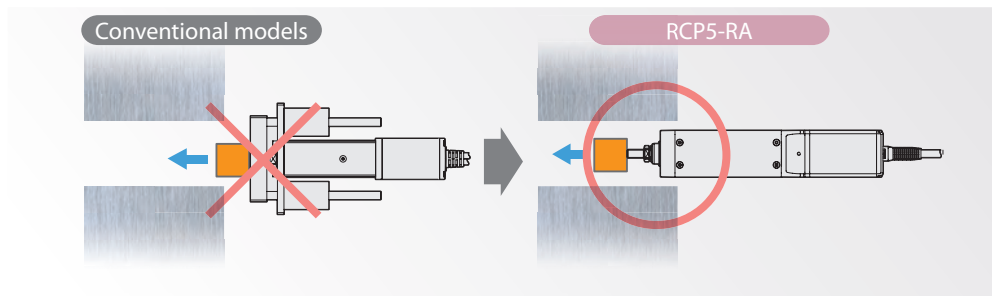

Usage example 2 When the rod needs to be straight

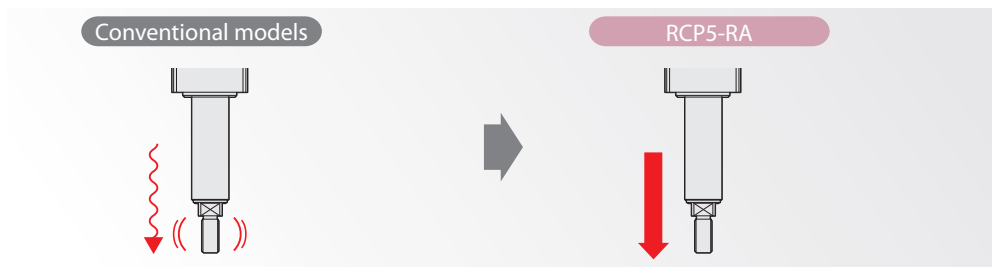

Feature

4

Easier to Maintain

Once the frame cover is removed, both the ball screw and guide can be greased at the same time using the right and left grease nipples. (For the RCP5-RA8/RA10 models, apply grease directly to the grease nipples without removing the frame cover.)

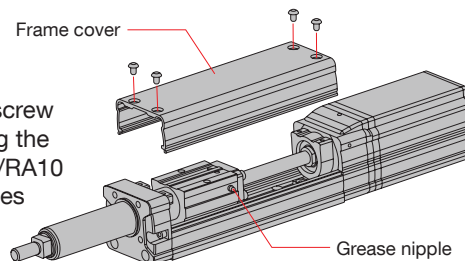

Feature











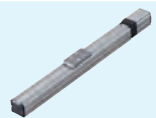

5

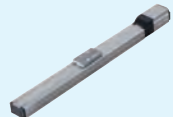
Added to the Series: Side-mounted Motor and Belt Type

In addition to the cleanroom type which is applicable for Cleanliness Class 10, the side-mounted motor and belt types have been added in the series.











The ROBO Cylinder is Easy to Use!!!

Slider Type →P. 15

Model	Type	External view	Actuator width	Stroke (mm)	Ball screw lead (mm)	Maximum speed (mm/s)	Maximum payload (kg)		Page	
							Horizontal	Vertical		
Straight motor specification	SA4C		 40 mm	50~500	16	1260	4	1	→P. 15	
					10	785	10	2.25		
					5	390	12	4.5		
					2.5	195	12	9		
	SA6C		 58 mm	50~800	20	1440<1280>	10	1	→P. 17	
					12	900	15	2.5		
					6	450	25	6		
	SA7C		 73 mm	50~800	24	1200	20	3	→P. 19	
					16	980<840>	40	8		
					8	490	45	16		
	Side-mounted motor specification	SA4R		 40 mm	50~500	16	1260	4	1	→P. 21
						10	785	10	2.25	
5						390	12	4.5		
2.5						195	12	9		
SA6R			 58 mm	50~800	20	1280	10	1	→P. 23	
					12	900<800>	15	2.5		
					6	450	25	6		
SA7R			 73 mm	50~800	24	1000	20	3	→P. 25	
					16	840<700>	40	8		
					8	490	45	16		
						4	210	45	25	

Values in brackets < > are for vertical use.









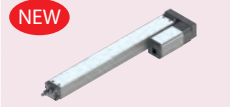

Rod Type →P. 27

Model	Type	External view	Actuator width	Stroke (mm)	Ball screw lead (mm)	Maximum speed (mm/s)	Maximum payload (kg)		Page
							Horizontal	Vertical	
Straight motor specification	RA4C		 40 mm	60~410	16	1120<840>	6	1.5	→P. 27
					10	700	15	2.5	
					5	350	28	5	
					2.5	175	40	10	
	RA6C		 58 mm	65~415	20	800	6	1.5	→P. 29
					12	700	25	4	
					6	450	40	10	
	RA7C		 73 mm	70~520	24	800<600>	20	3	→P. 31
					16	700<560>	50	8	
					8	420	60	18	
	RA8C		 88 mm	50~700	20	600<450>	30	5	→P. 33
					10	300<250>	60	40	
					5	150	100	70	
	RA10C		 108 mm	50~800	10	250<167>	80	80	→P. 35
					5	125	150	100	
					2.5	63	300	150	

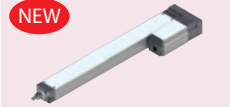
Values in brackets < > are for vertical use.

Rod Type







→P. 37

Model	Type	External view	Actuator width	Stroke (mm)	Ball screw lead (mm)	Maximum speed (mm/s)	Maximum payload (kg)		Page	
							Horizontal	Vertical		
Side-mounted motor specification	RA4R			60~410	40 mm	16	840	5	1	→P. 37
						10	610	12	2.5	
						5	350	25	5	
						2.5	175	40	10	
	RA6R			65~415	58 mm	20	800	6	1.5	→P. 39
						12	700	25	4	
						6	450	40	10	
						3	225	60	20	
	RA7R			70~520	73 mm	24	800<600>	20	3	→P. 41
						16	560	50	8	
						8	420<350>	60	18	
						4	175	80	28	
	RA8R			50~700	88 mm	20	400	30	5	→P. 43
						10	200	60	40	
						5	100	100	70	
RA10R			50~800	108 mm	10	200<140>	80	80	→P. 45	
					5	100	150	100		
					2.5	50	300	150		

Values in brackets < > are for vertical use.

Cleanroom Type







→P. 47

Type	External view	Actuator width	Stroke (mm)	Ball screw lead (mm)	Maximum speed (mm/s)	Maximum payload (kg)		Page	
						Horizontal	Vertical		
SA4C			50~500	40 mm	16	1260	4	1	→P. 47
					10	785	10	2.25	
					5	390	12	4.5	
					2.5	195	12	9	
SA6C			50~800	58 mm	20	1440<1280>	10	1	→P. 49
					12	900	15	2.5	
					6	450	25	6	
					3	225	25	16	
SA7C			50~800	73 mm	24	1200	20	3	→P. 51
					16	980<840>	40	8	
					8	490	45	16	
					4	245<210>	45	25	

Values in brackets < > are for vertical use.

Belt Type

→P. 53

Type	External view	Actuator width	Stroke (mm)	Ball screw lead (mm)	Maximum speed (mm/s)	Maximum payload (kg)	Page	
						Horizontal		
BA4/BA4U			300~1200	40 mm	Equivalent to 48	1200	1.5	→P. 53
BA6/BA6U			300~2200	58 mm	Equivalent to 48	1500	6	→P. 55
BA7/BA7U			300~2600	70 mm	Equivalent to 48	1600	16	→P. 57

Model Specification Items

Model Specification Items

<Slider type>

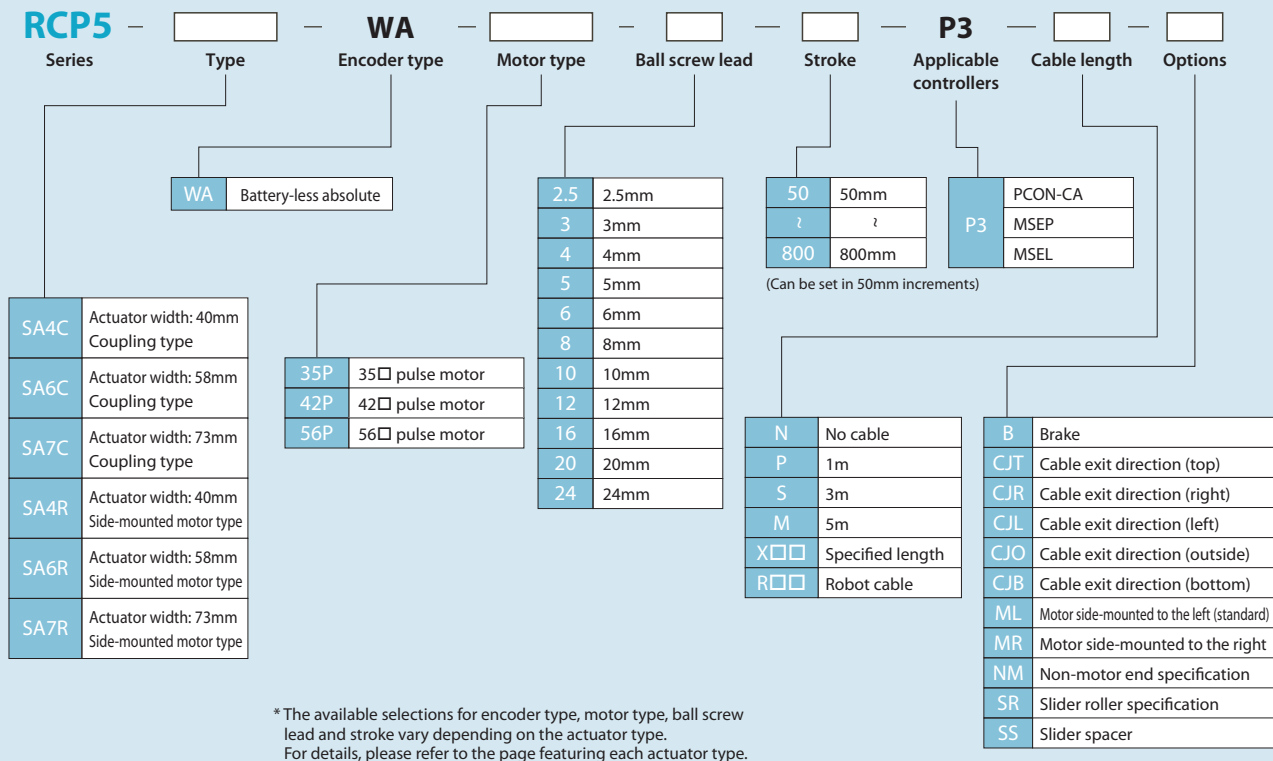

<Rod type: Straight motor specification>

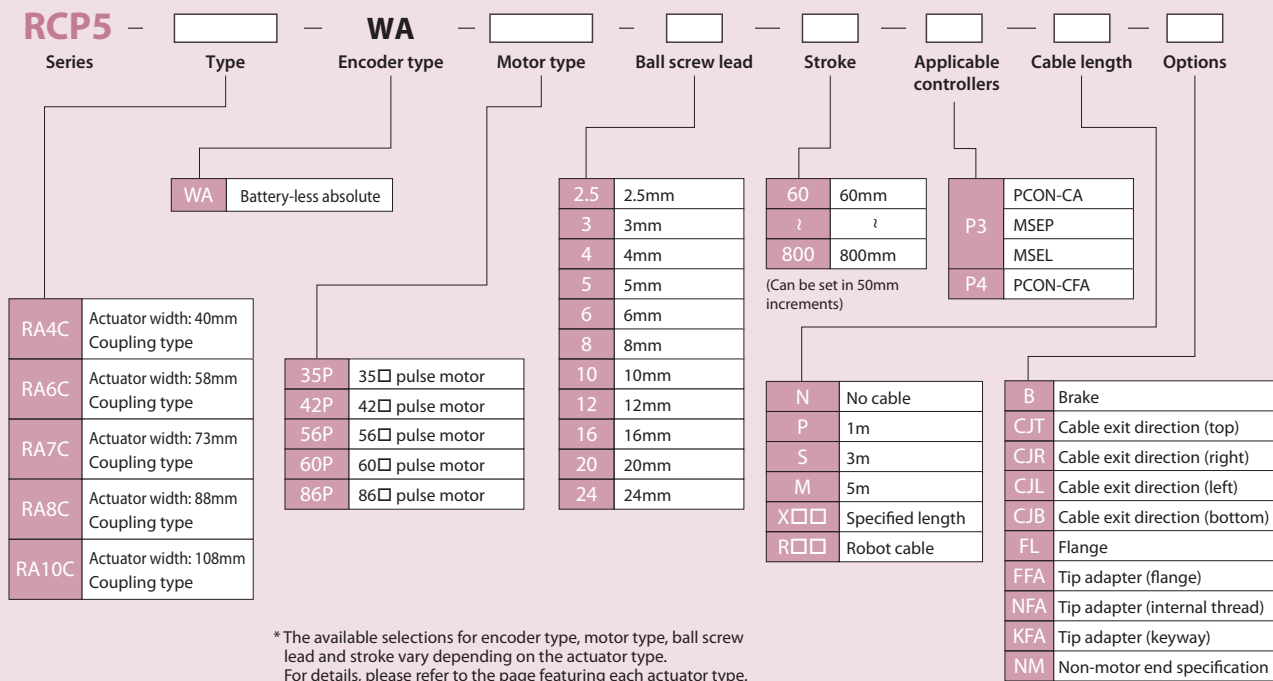

<Rod type: Side-mounted motor specification>

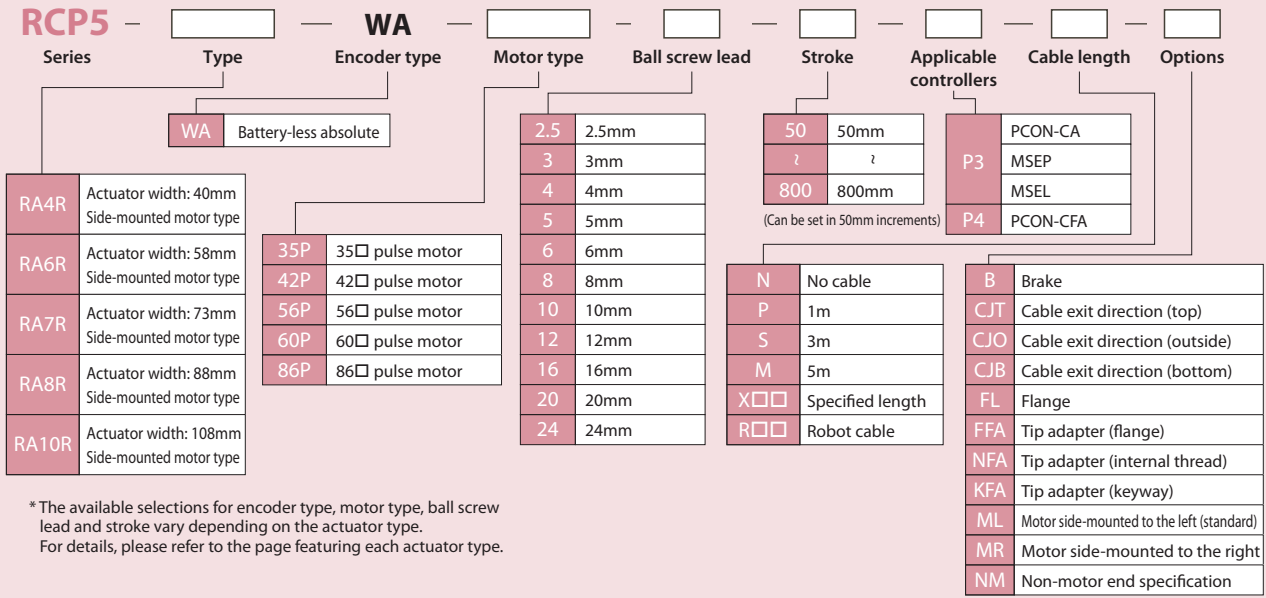

<Cleanroom type>

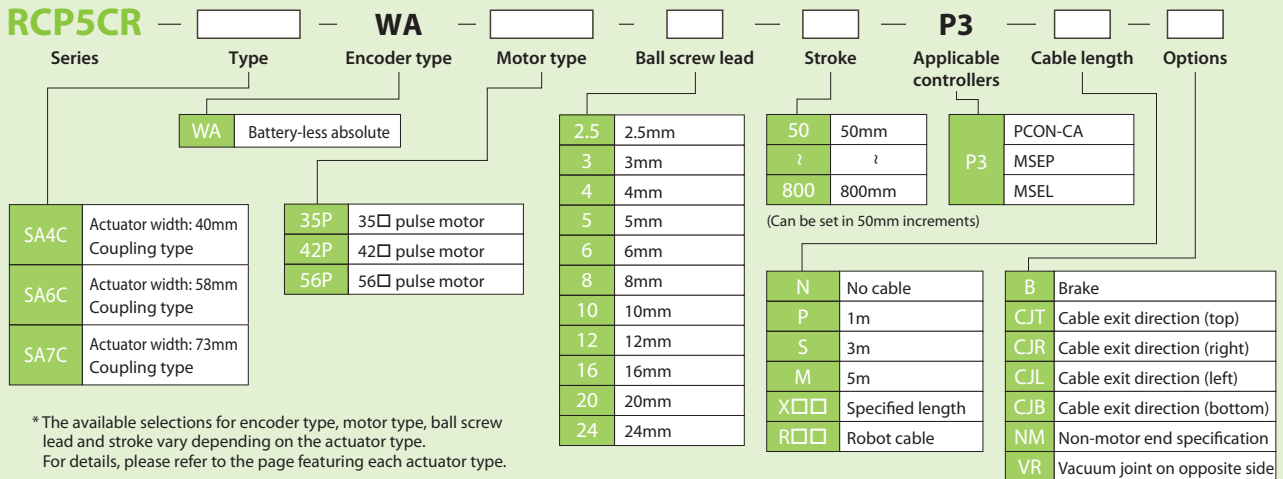

<Belt type>

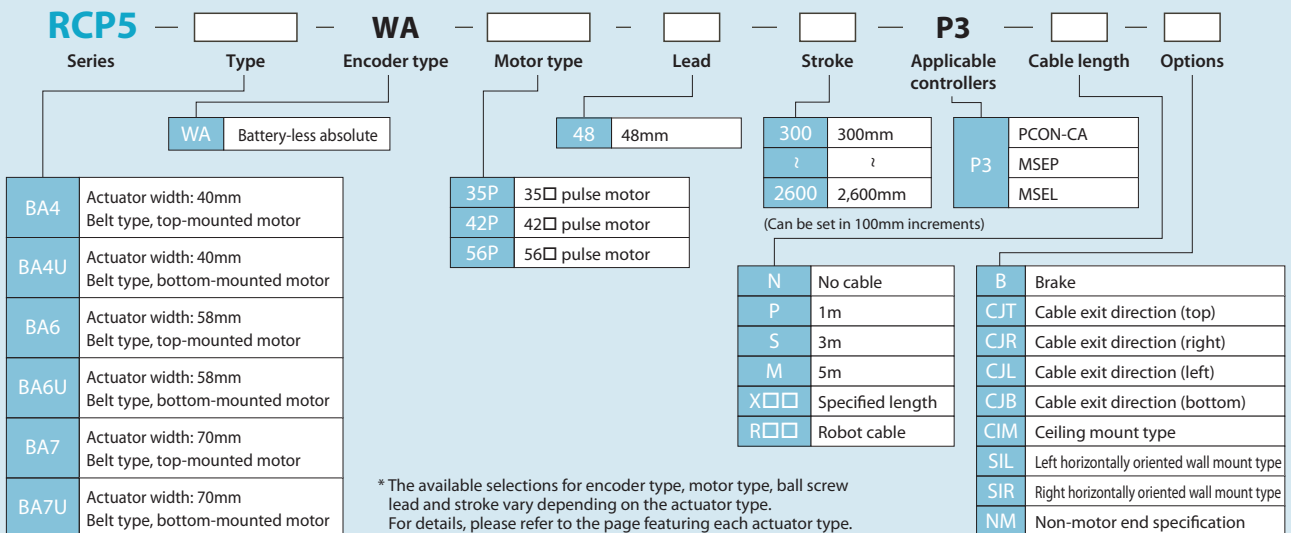

Options

Actuator Options

Brake

Option code: **B**

Applicable models **All models**

Description

This is a holding mechanism that prevents the slider from falling and damaging any attached fittings when the power or servo is turned off.

Optional cable exit direction

Option code: **CJT**

CJR

CJL

CJB

CJO

Applicable models **All models**

Description

This option allows you to change the exit direction of the motor-encoder cable to up, down, left or right.

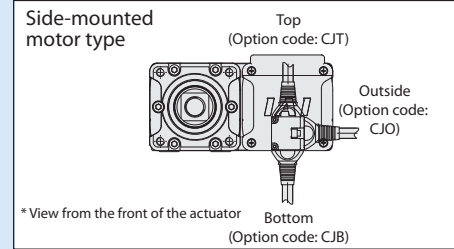
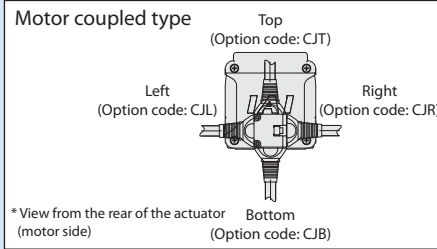

Side-mounted motor direction

Option code: **ML/MR**

* Please make sure to specify either "ML" or "MR" when ordering the side-mounted motor type.

Applicable models **RCP5-SA□R/RA□R**

Description

This allows you to specify the direction of the side-mounted motor. As viewed from the motor side of the actuator, ML represents left and MR represents right.

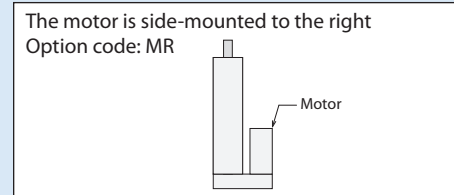
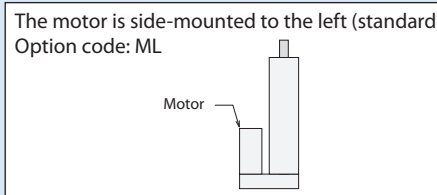

Non-motor end specification

Option code: **NM**

Applicable models **All models**

Description

This option changes the home position of the actuator's slider or rod from the normal position (motor-side), to the opposite side.

Slider spacer

Option code: **SS**

Applicable models **RCP5-SA7R**

Description

This option changes the top of the slider position to be higher than the motor height.

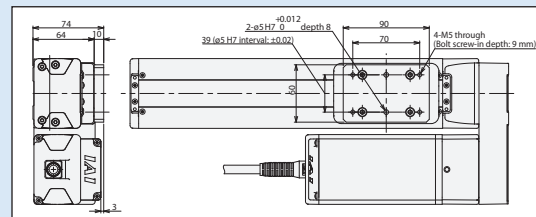

Slider roller specification

Option code: **SR**

Applicable models **RCP5-SA4□/SA6□/SA7□**

Description

The slider of the standard slider type specification is changed to the same roller structure of the cleanroom type. When using the slider roller specification, the appearance and dimensions of the slider cover will be the same as the cleanroom type.

Vacuum joint on opposite side

Option code: **VR**

Applicable models **RCP5CR-SA4C/SA6C/SA7C**

Description

The vacuum joint in the standard models are installed on the left side of the actuator as viewed from the motor side. This option changes the position to the right (opposite) side.

Rod Attachment Options

Front flange

Option code: **FL**

Applicable models RCP5-RA4□/RA6□/RA7□/RA8□/RA10□

Flange

Option code :
FL

Description | A bracket that attaches to the actuator body with bolts.



RCP5-RA4□

Model number of flange
RCP5-FL-RA4

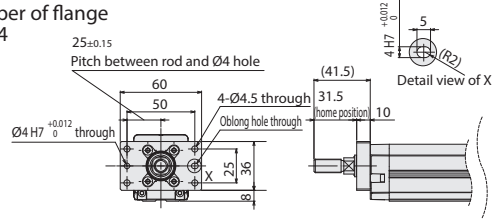

RCP5-RA6□

Model number of flange
RCP5-FL-RA6

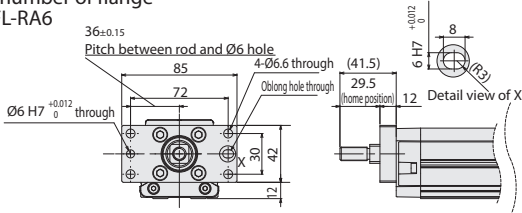

RCP5-RA7□

Model number of flange
RCP5-FL-RA7

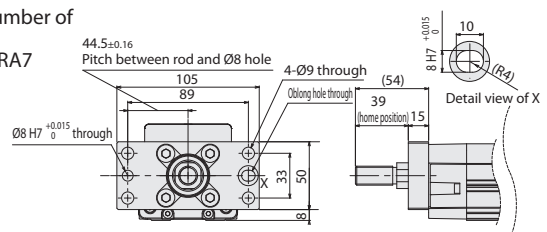

RCP5-RA8□

Model number of flange
RCP5-FL-RA8

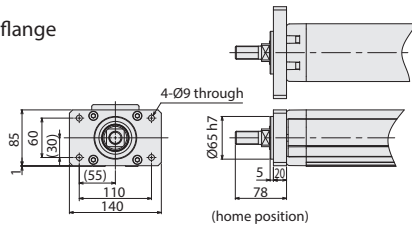

RCP5-RA10□

Model number of flange
RCP5-FL-RA10

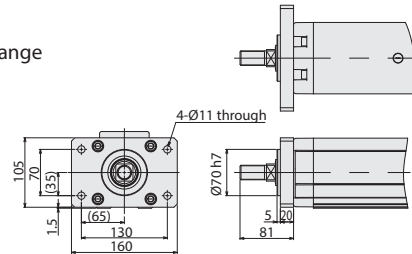

Tip Adapter (Flange)

Option code: **FFA**

Applicable models RCP5-RA4□/RA6□/RA7□

Tip Adapter (Flange)

Option code :
FFA

Description | A rod-end tooling adapter with 4 threaded holes.



RCP5-RA4□

Model number of tip adapter (flange)
RCP5-FFA-RA4

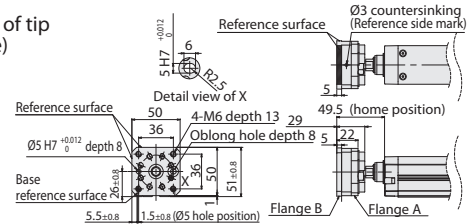

RCP5-RA6□

Model number of tip adapter (flange)
RCP5-FFA-RA6

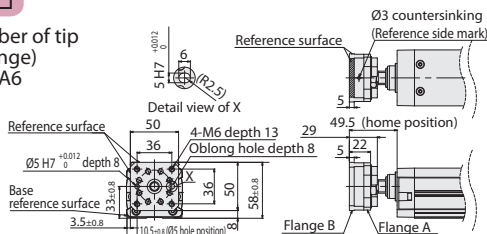

RCP5-RA7□

Model number of tip adapter (flange)
RCP5-FFA-RA7

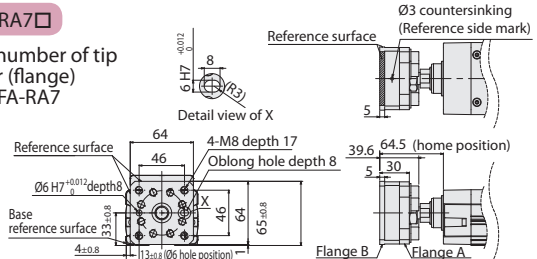

Rod Attachment Options

Tip Adapter (Internal Thread)

Option code: **NFA**

Applicable models RCP5-RA4□/RA6□/RA7□

Tip Adapter (Internal Thread):

Option code: **NFA**

Description | A threaded female tip adapter.



RCP5-RA4□

Model number of tip adapter (internal thread)
RCP5-NFA-RA4

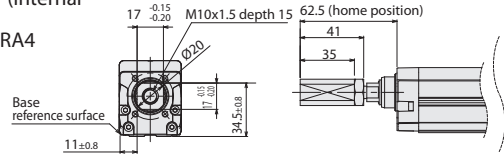

RCP5-RA6□

Model number of tip adapter (internal thread)
RCP5-NFA-RA6

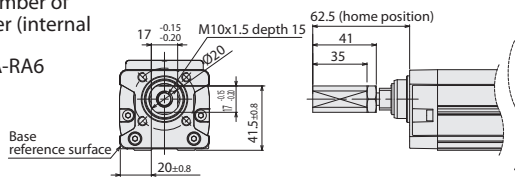

RCP5-RA7□

Model number of tip adapter (internal thread)
RCP5-NFA-RA7

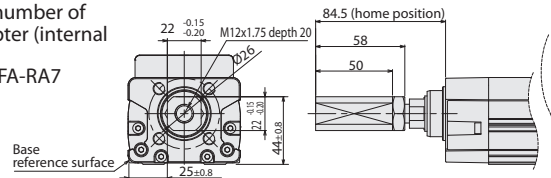

Tip Adapter (Keyway)

Option code: **KFA**

Applicable models RCP5-RA4□/RA6□/RA7□

Tip Adapter (Keyway)

Option code: **KFA**

Description | A female threaded tip adapter with a parallel keyway.



RCP5-RA4□

Model number of tip adapter (keyway)
RCP5-KFA-RA4

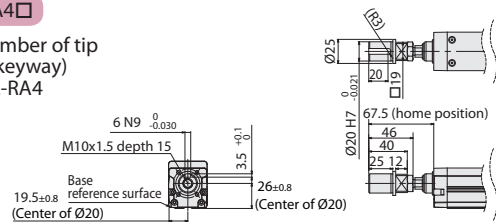

RCP5-RA6□

Model number of tip adapter (keyway)
RCP5-KFA-RA6

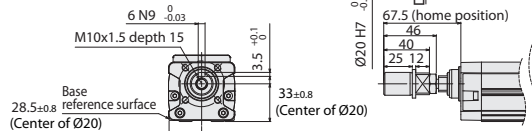

RCP5-RA7□

Model number of tip adapter (keyway)
RCP5-KFA-RA7

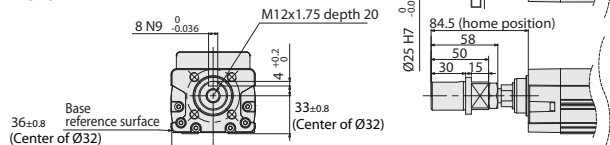

Warnings when Selecting the Rod Attachment Option

When Selecting the Front Flange (FL)

- The front flange (FL) rod attachment option cannot be selected when the following strokes are selected for RCP5-RA4R/RA6R/RA7R;

- (1) RA4R: 60mm (standard) and 60~110mm (with brake)
- (2) RA6R: 65mm (with brake)
- (3) RA7R: 70mm (standard) and 70~120mm (with brake)

- Please be careful of nearby objects when selecting the front flange (FL) option for the RCP5-RA4R/RA6R/RA7R models, as selecting a short stroke may cause some interference between the cable and installation surface for certain strokes.

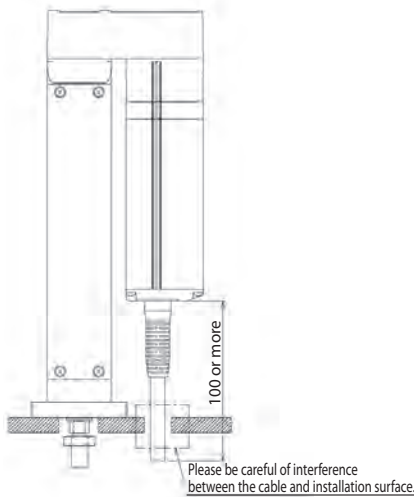

When Selecting the Tip Adapter Option (FFA, NFA, KFA)

- Please be careful of nearby objects when selecting the tip adapter option (FFA, NFA, KFA) for the RCP5-RA4R/RA6R/RA7R models, as selecting a short stroke may cause some interference between the cable and work piece for certain strokes.

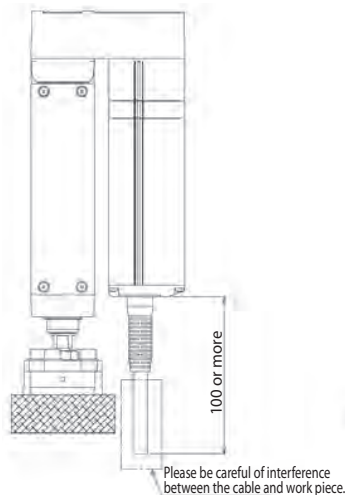
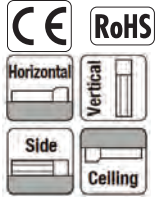

Figure above shows the case of tip adapter (Flange=FFA).

RCP5-SA4C ROBO Cylinder, Slider Type, Motor Unit Coupled, Actuator Width 40mm, 24V Pulse Motor

Model	RCP5	SA4C	WA	35P			P3		
Specification	Series	Type	Encoder type	Motor type	Lead	Stroke	Applicable controllers	Cable length	Options
Items			WA: Battery-less absolute specification	35P: Pulse motor, size 35□	16: 16mm 10: 10mm 5: 5mm 2.5: 2.5mm	50: 50mm 500: 500mm (Every 50mm)	P3: PCON-CA MSEP MSEL	N: No cable P: 1m S: 3m M: 5m X□: Specified length R□: Robot cable	Please refer to the options table below.

*Controller is not included.



* Depending on the model, there may be some limitations to using the vertical, side, and ceiling mount positions. Please refer to P.59 for details.



POINT
Note on selection

(1) The actuator specification displays the payload's maximum value, but it will vary depending on the acceleration. Please refer to the "Selection Guidelines" (RCP5 Payload by Speed/Acceleration Table) on P. 61.
(2) Please refer to P. 59 for push-motion operation.

Correlation Diagrams of Speed and Payload

(1) High-output enabled with PCON-CA, MSEP, MSEL connected

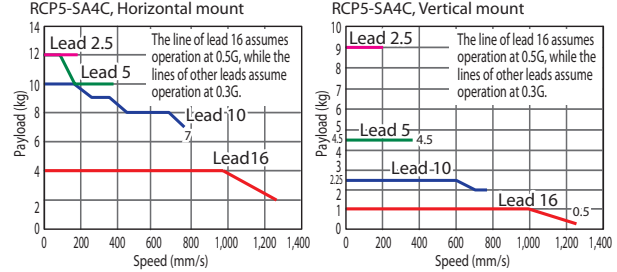

(2) High-output disabled with PCON-CA, MSEP connected

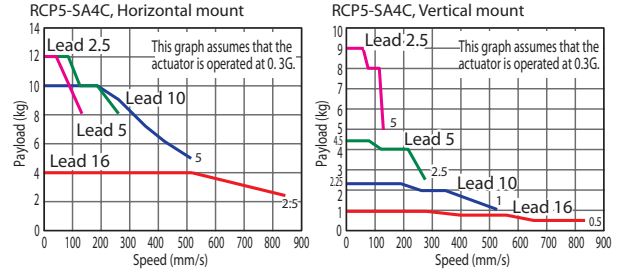

Actuator Specifications

Lead and Payload

Model number	Lead (mm)	Connected controller	Maximum payload		Stroke (mm)
			Horizontal (kg)	Vertical (kg)	
RCP5-SA4C-WA-35P-16-①-P3-②-③	16	High-output enabled	4	1	50~500 (Every 50mm)
		High-output disabled			
RCP5-SA4C-WA-35P-10-①-P3-②-③	10	High-output enabled	10	2.25	
		High-output disabled			
RCP5-SA4C-WA-35P-5-①-P3-②-③	5	High-output enabled	12	4.5	
		High-output disabled			
RCP5-SA4C-WA-35P-2.5-①-P3-②-③	2.5	High-output enabled	12	9	
		High-output disabled			

Legend: ① Stroke ② Cable length ③ Options *Please refer to P. 59 for push-motion operation.

Stroke and Maximum Speed

(Unit: mm/s)

Lead (mm)	Connected controller	50~400 (Every 50mm)	450 (mm)	500 (mm)
16	High-output enabled	1,260	1,060	875
	High-output disabled	840		
10	High-output enabled	785	675	555
	High-output disabled	525		
5	High-output enabled	390	330	275
	High-output disabled	260		
2.5	High-output enabled	195	165	135
	High-output disabled	130		

① Stroke

Stroke (mm)	Standard price	Stroke (mm)	Standard price
50	-	300	-
100	-	350	-
150	-	400	-
200	-	450	-
250	-	500	-

② Cable Length

Type	Cable code	Standard price	
Standard type	P (1m)	-	
	S (3m)	-	
	M (5m)	-	
Special length	X06 (6m) ~X10 (10m)	-	
	X11 (11m)~X15 (15m)	-	
	X16 (16m)~X20 (20m)	-	
	R01 (1m) ~R03 (3m)	-	
Robot cable	R04 (4m) ~R05 (5m)	-	
	R06 (6m) ~R10 (10m)	-	
	R11 (11m)~R15 (15m)	-	
	R16 (16m)~R20 (20m)	-	

*Please refer to P. 89 for maintenance cables.

③ Options

Name	Option code	Reference page	Standard price
Brake	B	→P. 11	-
Cable exit direction (Top)	CJT	→P. 11	-
Cable exit direction (Right)	CJR	→P. 11	-
Cable exit direction (Left)	CJL	→P. 11	-
Cable exit direction (Bottom)	CJB	→P. 11	-
Slider roller specification	SR	→P. 11	-
Non-motor end specification	NM	→P. 11	-

Actuator Specifications

Item	Description
Drive system	Ball screw Ø8mm, rolled C10
Positioning repeatability	±0.02mm
Lost motion	0.1mm or less
Base	Material: Aluminum with white alumite treatment
Dynamic allowable moment (*1)	Ma: 4.98N·m, Mb: 7.11N·m, Mc: 9.68N·m
Static allowable moment	Ma: 8.6N·m, Mb: 12.2N·m, Mc: 16.7N·m
Ambient operating temperature, humidity	0 to 40°C, 85% RH or less (Non-condensing)

*Reference for overhang load length/Ma: 120mm or less, Mb, Mc: 120mm or less

(*1) Assumes a standard rated life of 5,000km.

(*) The operational life will vary depending on operation and installation conditions. Please refer to the general catalog for details on operational life, allowable moment direction, and overhang load length.

Dimensions

CAD drawings can be downloaded from our website. www.intelligentactuator.com



- *1 When the slider is returning to its home position, please be careful of interference from surrounding objects, as it will travel until it reaches the ME.
- ME: Mechanical end
- SE: Stroke end
- *2 Please see P.48 for slider roller specification (SR).

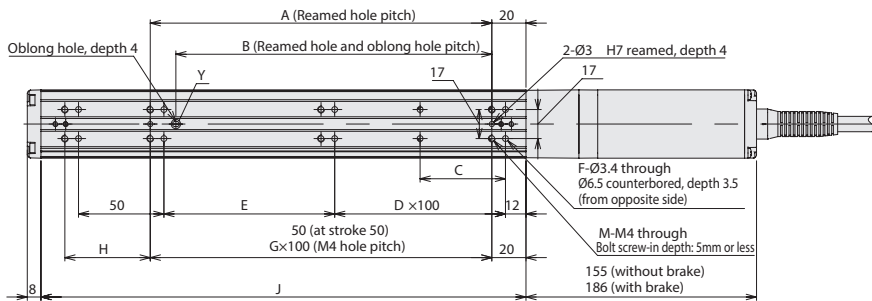
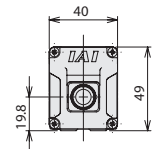
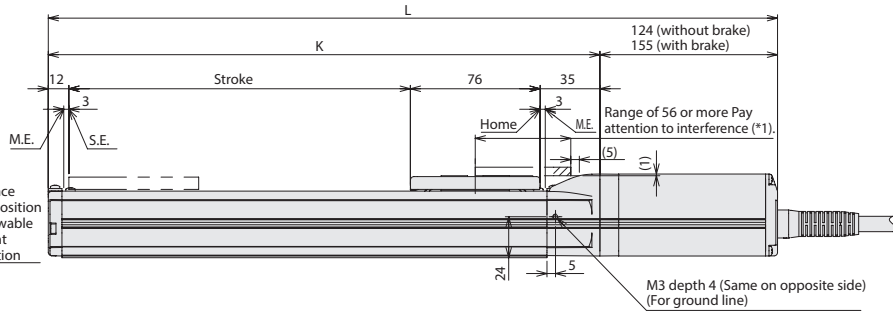
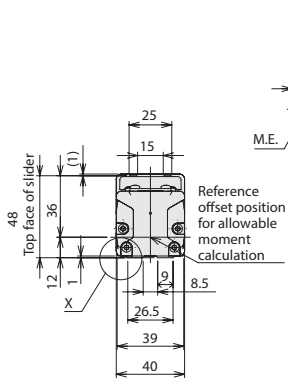
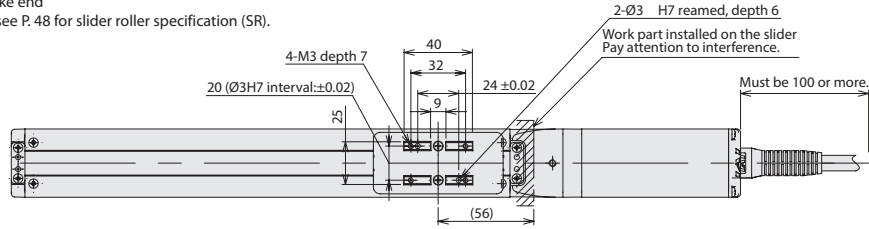
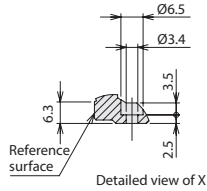

Cable Exit Direction (Option)

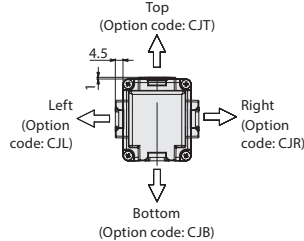
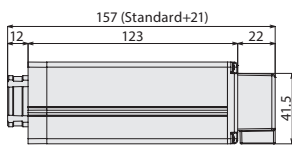

Dimensions and Mass by Stroke

Stroke	Stroke										
	50	100	150	200	250	300	350	400	450	500	
L	Without brake	297	347	397	447	497	547	597	647	697	747
	With brake	328	378	428	478	528	578	628	678	728	778
A	50	100	100	200	200	300	300	400	400	500	
B	35	85	85	185	185	285	285	385	385	485	
C	25	50	50	50	50	50	50	50	50	50	
D	0	0	1	1	2	2	3	3	4	4	
E	50	100	50	100	50	100	50	100	50	100	
F	8	8	10	10	12	12	14	14	16	16	
G	0	1	1	2	2	3	3	4	4	5	
H	50	50	100	50	100	50	100	50	100	50	
J	134	184	234	284	334	384	434	484	534	584	
K	173	223	273	323	373	423	473	523	573	623	
M	6	6	6	8	8	10	10	12	12	14	
Mass (kg)	Without brake	1.0	1.1	1.2	1.3	1.3	1.4	1.5	1.6	1.7	1.8
	With brake	1.2	1.3	1.4	1.5	1.5	1.6	1.7	1.8	1.9	2.0

Applicable Controllers

The RCP5 series actuators can be operated by the controllers indicated below. Please select the type depending on your intended use.

Name	External view	Model number	Max. number of controlled axes	Maximum number of positioning points	Input power	Standard price	Reference page
Positioner type (High-output specification)		PCON-CA-35PWAI-①-2-0	1	512 points	DC24V	-	→P.69
Pulse train type (High-output specification)		PCON-CA-35PWAI-PL②-2-0				-	
Network type (High-output specification)		PCON-CA-35PWAI-③-0-0				-	
Solenoid valve multi-axis type (PIO specification)		MSEL-④-⑤-⑥-⑦-⑧-⑨-⑩-2-0	C: 8 (4 when high-output enabled) LC: 6 (3 when high-output enabled)	3 points	-	-	→P.77
Solenoid valve multi-axis type (Network specification)		MSEL-④-⑤-⑥-⑦-⑧-⑨-⑩-0-0				256 points	
Program control multi-axis type		MSEL-PC-1-35PWAI-①-2-4	4	30,000 points	Single-phase AC 100V~230V	-	→P.87
Program control multi-axis type (w/network board)		MSEL-PC-1-35PWAI-②-0-4				-	
Program control multi-axis type (Safety category compliant spec.)		MSEL-PG-1-35PWAI-③-2-4				-	
Program control multi-axis type (Safety category compliant spec. w/network board)		MSEL-PG-1-35PWAI-④-0-4				-	

*Above MSEL models are for single-axis specification *① I/O type (NP/PN) *② Number of axes
 *③ Field network specification code *④ C or LC *⑤ N (NPN specification) or P (PNP specification) code
 *The high output enabled operation is only available when the "High-output setting specs" is selected in the MSEL-C/LC.

RCP5-SA6C ROBO Cylinder, Slider Type, Motor Unit Coupled, Actuator Width 58mm, 24V Pulse Motor

Model	RCP5	SA6C	WA	42P			P3		
Specification	Series	Type	Encoder type	Motor type	Lead	Stroke	Applicable controllers	Cable length	Options
Items			WA: Battery-less absolute specification	42P: Pulse motor, size 42□	20: 20mm 12: 12mm 6: 6mm 3: 3mm	50: 50mm 800: 800mm (Every 50mm)	P3: PCON-CA MSEP MSEL	N: No cable P: 1m S: 3m M: 5m X□: Specified length R□: Robot cable	Please refer to the options table below.

*Controller is not included.

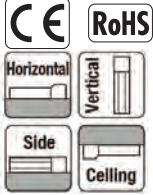

* Depending on the model, there may be some limitations to using the vertical, side, and ceiling mount positions. Please refer to P.59 for details.

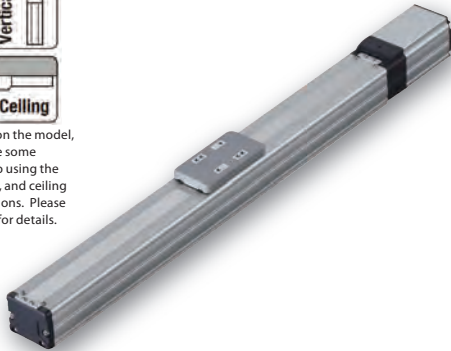

POINT
Note on selection

(1) The actuator specification displays the payload's maximum value, but it will vary depending on the acceleration. Please refer to the "Selection Guidelines" (RCP5 Payload by Speed/Acceleration Table) on P. 61.

(2) Please refer to P. 59 for push-motion operation.

Correlation Diagrams of Speed and Payload

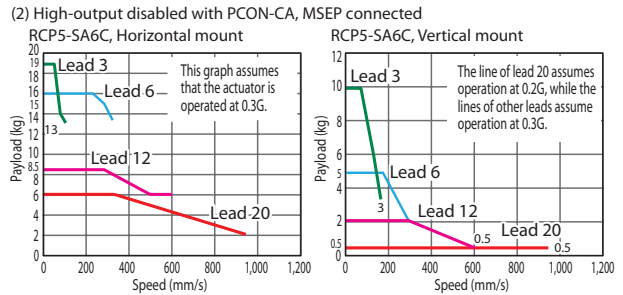
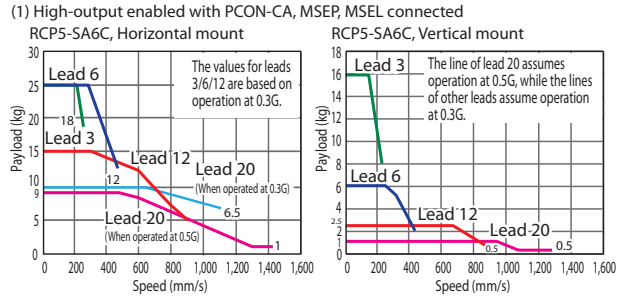

Actuator Specifications

Lead and Payload

Model number	Lead (mm)	Connected controller	Maximum payload		Stroke (mm)
			Horizontal (kg)	Vertical (kg)	
RCP5-SA6C-WA-42P-20-①-P3-②-③	20	High-output enabled	10	1	50~800 (Every 50mm)
		High-output disabled	6	0.5	
RCP5-SA6C-WA-42P-12-①-P3-②-③	12	High-output enabled	15	2.5	
		High-output disabled	8.5	2	
RCP5-SA6C-WA-42P-6-①-P3-②-③	6	High-output enabled	25	6	
		High-output disabled	16	5	
RCP5-SA6C-WA-42P-3-①-P3-②-③	3	High-output enabled	25	16	
		High-output disabled	19	10	

Legend: ① Stroke ② Cable length ③ Options *Please refer to P.59 for push-motion operation.

Stroke and Maximum Speed

Values in brackets < > are for vertical use. (Unit: mm/s)

Lead (mm)	Connected controller	50~400 (Every 50mm)	450 (mm)	500 (mm)	550 (mm)	600 (mm)	650 (mm)	700 (mm)	750 (mm)	800 (mm)
20	High-output enabled	1,440 <1,280>	1,335 <1,280>	1,130	970	840	735	650	575	
	High-output disabled	960				840	735	650	575	
12	High-output enabled	900	885	735	620	535	460	405	355	315
	High-output disabled	600				535	460	405	355	315
6	High-output enabled	450	435	365	305	265	230	200	175	155
	High-output disabled	300				265	230	200	175	155
3	High-output enabled	225	215	180	150	130	115	100	85	75
	High-output disabled	150				130	115	100	85	75

① Stroke

Stroke (mm)	Standard price	Stroke (mm)	Standard price
50	-	450	-
100	-	500	-
150	-	550	-
200	-	600	-
250	-	650	-
300	-	700	-
350	-	750	-
400	-	800	-

② Cable Length

Type	Cable code	Standard price
Standard type	P (1m)	-
	S (3m)	-
	M (5m)	-
Special length	X06 (6m) ~X10 (10m)	-
	X11 (11m)~X15 (15m)	-
	X16 (16m)~X20 (20m)	-
	R01 (1m) ~R03 (3m)	-
Robot cable	R04 (4m) ~R05 (5m)	-
	R06 (6m) ~R10 (10m)	-
	R11 (11m)~R15 (15m)	-
	R16 (16m)~R20 (20m)	-

*Please refer to P. 89 for maintenance cables.

③ Options

Name	Option code	Reference page	Standard price
Brake	B	→P. 11	-
Cable exit direction (Top)	CJT	→P. 11	-
Cable exit direction (Right)	CJR	→P. 11	-
Cable exit direction (Left)	CJL	→P. 11	-
Cable exit direction (Bottom)	CJB	→P. 11	-
Slider roller specification	SR	→P. 11	-
Non-motor end specification	NM	→P. 11	-

Actuator Specifications

Item	Description
Drive system	Ball screw Ø10mm, rolled C10
Positioning repeatability (*1)	±0.02mm [±0.03mm]
Lost motion	0.1mm or less
Base	Material: Aluminum with white alumite treatment
Dynamic allowable moment (*2)	Ma: 11.6N·m, Mb: 16.6N·m, Mc: 24.6N·m
Static allowable moment	Ma: 38.3N·m, Mb: 54.7N·m, Mc: 81N·m
Ambient operating temperature, humidity	0 to 40°C, 85% RH or less (Non-condensing)

*Reference for overhang load length/Ma: 150mm or less, Mb, Mc: 150mm or less

(*1) The values in brackets [] are for Lead 20.

(*2) Assumes a standard rated life of 5,000km.

(*3) The operational life will vary depending on operation and installation conditions. Please refer to the general catalog for details on operational life, allowable moment direction, and overhang load length.

Dimensions

CAD drawings can be downloaded from our website. www.intelligentactuator.com



*1 When the slider is returning to its home position, please be careful of interference from surrounding objects, as it will travel until it reaches the ME.

ME: Mechanical end

SE: Stroke end

*2 Please see P.50 for slider roller specification (SR).

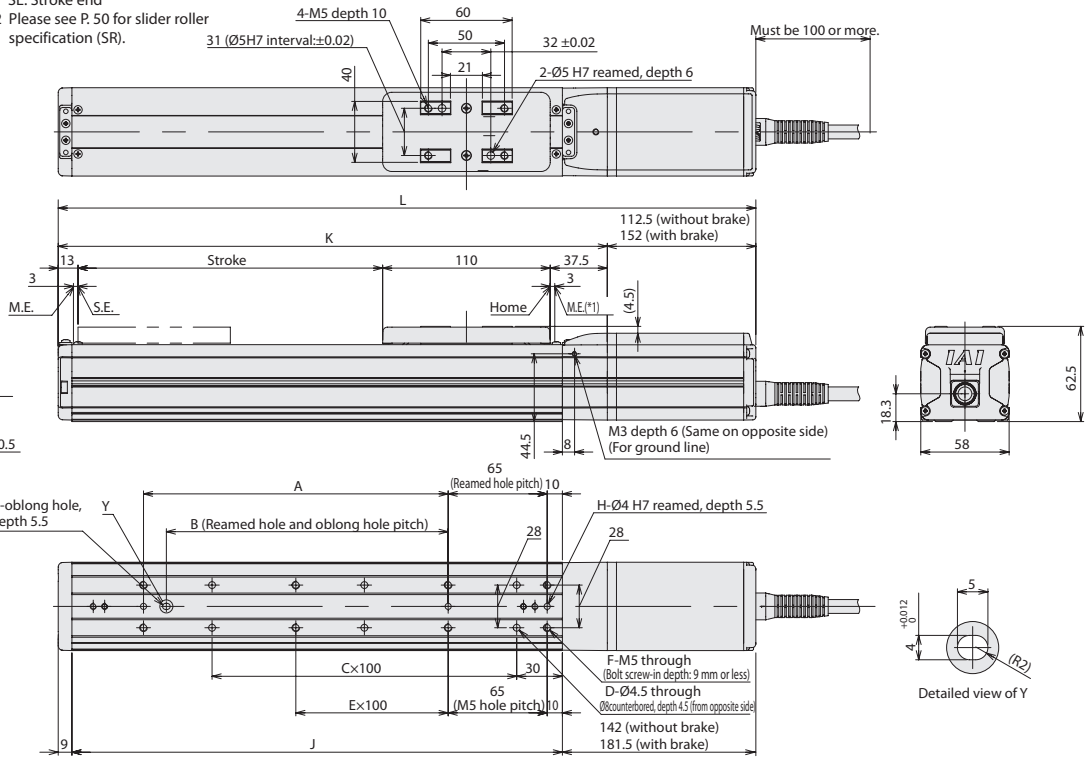
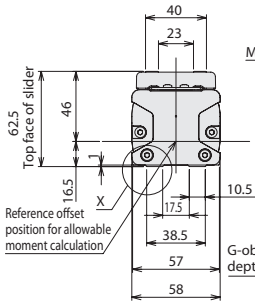
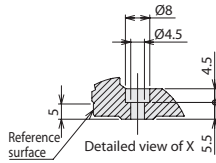

■ Cable Exit Direction (Option)

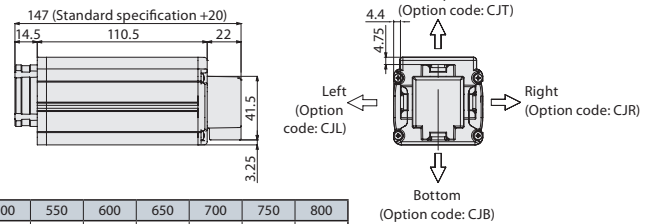

■ Dimensions and Mass by Stroke

Stroke	50	100	150	200	250	300	350	400	450	500	550	600	650	700	750	800	
L	Without brake	323	373	423	473	523	573	623	673	723	773	823	873	923	973	1,023	1,073
	With brake	362.5	412.5	462.5	512.5	562.5	612.5	662.5	712.5	762.5	812.5	862.5	912.5	962.5	1,012.5	1,062.5	1,112.5
A	0	100	100	200	200	300	300	400	400	500	500	600	600	700	700	800	800
B	0	85	85	185	185	285	285	385	385	485	485	585	585	685	685	785	785
C	1	1	2	2	3	3	4	4	5	5	6	6	7	7	8	8	8
D	4	4	6	6	8	8	10	10	12	12	14	14	16	16	18	18	18
E	0	0	0	1	1	1	2	2	3	3	4	4	5	5	6	6	7
F	4	6	6	8	8	10	10	12	12	14	14	16	16	18	18	20	20
G	0	1	1	1	1	1	1	1	1	1	1	1	1	1	1	1	1
H	2	3	3	3	3	3	3	3	3	3	3	3	3	3	3	3	3
J	172	222	272	322	372	422	472	522	572	622	672	722	772	822	872	922	922
K	210.5	260.5	310.5	360.5	410.5	460.5	510.5	560.5	610.5	660.5	710.5	760.5	810.5	860.5	910.5	960.5	960.5
Mass (kg)	Without brake	1.7	1.8	2.0	2.2	2.4	2.5	2.7	2.9	3.1	3.2	3.4	3.6	3.8	3.9	4.1	4.3
	With brake	1.9	2.0	2.2	2.4	2.6	2.7	2.9	3.1	3.3	3.4	3.6	3.8	4.0	4.1	4.3	4.5

Applicable Controllers

The RCP5 series actuators can be operated by the controllers indicated below. Please select the type depending on your intended use.

Name	External view	Model number	Max. number of controlled axes	Maximum number of positioning points	Input power	Standard price	Reference page
Positioner type (High-output specification)		PCON-CA-42PWAI-①-2-0	1	512 points	DC24V	-	→P.69
Pulse train type (High-output specification)		PCON-CA-42PWAI-PL②-2-0				-	
Network type (High-output specification)		PCON-CA-42PWAI-③-0-0				-	
Solenoid valve multi-axis type (PIO specification)		MSEP-④-⑤-⑥-⑦-2-0	C: 8 (4 when high-output enabled) LC: 6 (3 when high-output enabled)	3 points	Single-phase AC 100V~230V	-	→P.77
Solenoid valve multi-axis type (Network specification)		MSEP-④-⑤-⑥-⑦-0-0				256 points	
Program control multi-axis type		MSEL-PC-1-42PWAI-①-2-4	4	30,000 points	Single-phase AC 100V~230V	-	→P.87
Program control multi-axis type (w/network board)		MSEL-PC-1-42PWAI-③-0-4				-	
Program control multi-axis type (Safety category compliant spec.)		MSEL-PG-1-42PWAI-④-2-4				-	
Program control multi-axis type (Safety category compliant spec. w/network board)		MSEL-PG-1-42PWAI-④-0-4				-	

*Above MSEL models are for single-axis specification

*① I/O type (NP/PN)

*② Number of axes

*③ Field network specification code

*④ C or LC

*⑤ N (NPN specification) or P (PNP specification) code

*The high output enabled operation is only available when the "High-output setting specs" is selected in the MSEP-C/LC.

RCP5-SA7C ROBO Cylinder, Slider Type, Motor Unit Coupled, Actuator Width 73mm, 24V Pulse Motor

Model	RCP5	SA7C	WA	56P			P3		
Specification	Series	Type	Encoder type	Motor type	Lead	Stroke	Applicable controllers	Cable length	Options
Items			WA: Battery-less absolute specification	56P: Pulse motor, size 56□	24: 24mm 16: 16mm 8: 8mm 4: 4mm	50: 50mm 800: 800mm (Every 50mm)	P3: PCON-CA MSEP MSEL	N: No cable P: 1m S: 3m M: 5m X□: Specified length R□: Robot cable	Please refer to the options table below.

*Controller is not included.

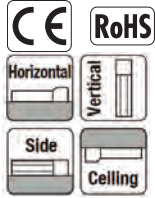

* Depending on the model, there may be some limitations to using the vertical, side, and ceiling mount positions. Please refer to P.59 for details.



POINT
Note on selection

(1) The actuator specification displays the payload's maximum value, but it will vary depending on the acceleration. Please refer to the "Selection Guidelines" (RCP5 Payload by Speed/Acceleration Table) on P. 61.

(2) Please refer to P. 59 for push-motion operation.

Correlation Diagrams of Speed and Payload

(1) High-output enabled with PCON-CA, MSEP, MSEL connected

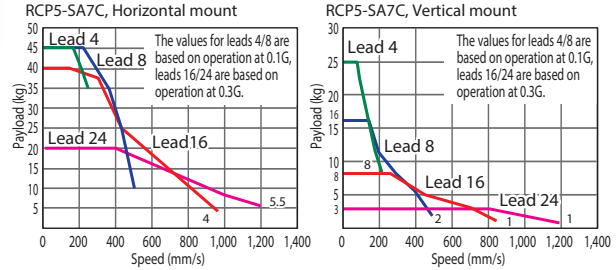

(2) High-output disabled with PCON-CA, MSEP connected

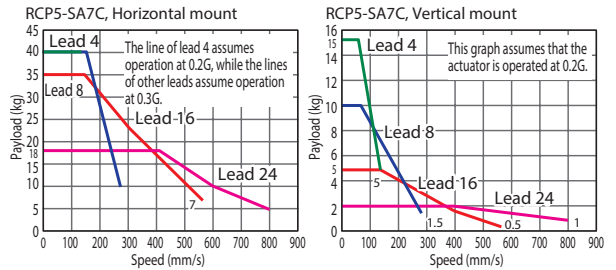

Actuator Specifications

Lead and Payload

Model number	Lead (mm)	Connected controller	Maximum payload		Stroke (mm)
			Horizontal (kg)	Vertical (kg)	
RCP5-SA7C-WA-56P-24-①-P3-②-③	24	High-output enabled	20	3	50~800 (Every 50mm)
		High-output disabled	18	2	
RCP5-SA7C-WA-56P-16-①-P3-②-③	16	High-output enabled	40	8	
		High-output disabled	35	5	
RCP5-SA7C-WA-56P-8-①-P3-②-③	8	High-output enabled	45	16	
		High-output disabled	40	10	
RCP5-SA7C-WA-56P-4-①-P3-②-③	4	High-output enabled	45	25	
		High-output disabled	40	15	

Legend: ① Stroke ② Cable length ③ Options *Please refer to P. 59 for push-motion operation.

Stroke and Maximum Speed

Values in brackets <> are for vertical use. (Unit: mm/s)

Lead (mm)	Connected controller	Maximum speed (mm/s)					
		50~550 (Every 50mm)	600 (mm)	650 (mm)	700 (mm)	750 (mm)	800 (mm)
24	High-output enabled	1,200	1,145	1,000	885	785	
	High-output disabled	800					785
16	High-output enabled	980 <840>	875 <840>	755	660	585	
	High-output disabled	560					520
8	High-output enabled	490	430	375	325	290	
	High-output disabled	280					255
4	High-output enabled	245 <210>	215 <210>	185	160	140	
	High-output disabled	140					125

① Stroke

Stroke (mm)	Standard price	Stroke (mm)	Standard price
50	-	450	-
100	-	500	-
150	-	550	-
200	-	600	-
250	-	650	-
300	-	700	-
350	-	750	-
400	-	800	-

② Cable Length

Type	Cable code	Standard price	Type	Cable code	Standard price
Standard type	P (1m)	-	Robot cable	R01 (1m) ~R03 (3m)	-
	S (3m)	-		R04 (4m) ~R05 (5m)	-
	M (5m)	-		R06 (6m) ~R10 (10m)	-
Special length	X06 (6m) ~X10 (10m)	-		R11 (11m)~R15 (15m)	-
	X11 (11m)~X15 (15m)	-		R16 (16m)~R20 (20m)	-
	X16 (16m)~X20 (20m)	-			

*Please refer to P. 89 for maintenance cables.

③ Options

Name	Option code	Reference page	Standard price
Brake	B	→P. 11	-
Cable exit direction (Top)	CJT	→P. 11	-
Cable exit direction (Right)	CJR	→P. 11	-
Cable exit direction (Left)	CJL	→P. 11	-
Cable exit direction (Bottom)	CJB	→P. 11	-
Slider roller specification	SR	→P. 11	-
Non-motor end specification	NM	→P. 11	-

Actuator Specifications

Item	Description
Drive system	Ball screw Ø12mm, rolled C10
Positioning repeatability (*1)	±0.02mm [±0.03mm]
Lost motion	0.1mm or less
Base	Material: Aluminum with white alumite treatment
Dynamic allowable moment (*2)	Ma: 11.6N·m, Mb: 16.6N·m, Mc: 33.7N·m
Static allowable moment	Ma: 51.2N·m, Mb: 73.1N·m, Mc: 148N·m
Ambient operating temperature, humidity	0 to 40°C, 85% RH or less (Non-condensing)

*Reference for overhang load length/Ma: 230mm or less, Mb, Mc: 230mm or less

(*1) The values in brackets [] are for Lead 24.

(*2) Assumes a standard rated life of 5,000km.

(*3) The operational life will vary depending on operation and installation conditions. Please refer to the general catalog for details on operational life, allowable moment direction, and overhang load length.

Dimensions

CAD drawings can be downloaded from our website. www.intelligentactuator.com



*1 When the slider is returning to its home position, please be careful of interference from surrounding objects, as it will travel until it reaches the ME.

ME: Mechanical end
SE: Stroke end
*2 Please see P.52 for slider roller specification (SR).

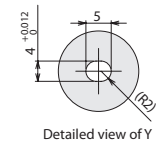
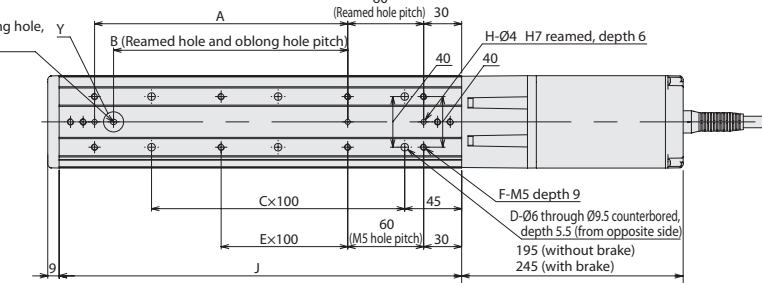
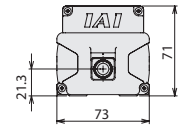
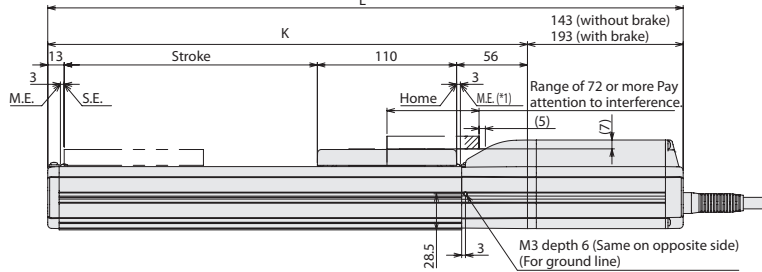
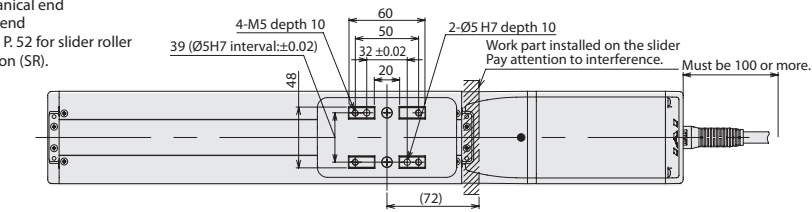
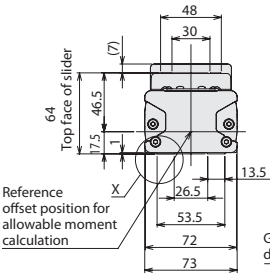
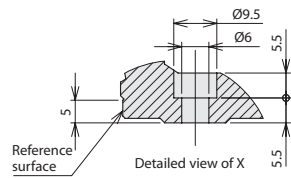

■ Cable Exit Direction (Option)

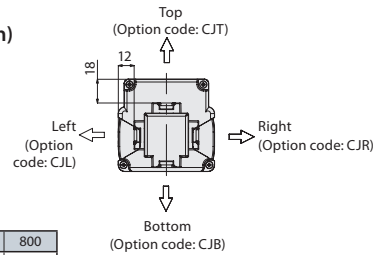
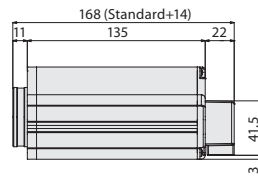

■ Dimensions and Mass by Stroke

Stroke	50	100	150	200	250	300	350	400	450	500	550	600	650	700	750	800
	L	372	422	472	522	572	622	672	722	772	822	872	922	972	1,022	1,072
Without brake	372	422	472	522	572	622	672	722	772	822	872	922	972	1,022	1,072	1,122
With brake	422	472	522	572	622	672	722	772	822	872	922	972	1,022	1,072	1,122	1,172
A	0	100	100	200	200	300	300	400	400	500	500	600	600	700	700	800
B	0	85	85	185	185	285	285	385	385	485	485	585	585	685	685	785
C	1	1	2	2	3	3	4	4	5	5	6	6	7	7	8	8
D	4	4	6	6	8	8	10	10	12	12	14	14	16	16	18	18
E	0	0	0	1	1	2	2	3	3	4	4	5	5	6	6	7
F	4	6	6	8	8	10	10	12	12	14	14	16	16	18	18	20
G	0	1	1	1	1	1	1	1	1	1	1	1	1	1	1	1
H	2	3	3	3	3	3	3	3	3	3	3	3	3	3	3	3
J	168	218	268	318	368	418	468	518	568	618	668	718	768	818	868	918
K	229	279	329	379	429	479	529	579	629	679	729	779	829	879	929	979
Mass (kg)																
Without brake	3.0	3.2	3.5	3.7	3.9	4.1	4.4	4.6	4.8	5.0	5.3	5.5	5.7	5.9	6.1	6.4
With brake	3.5	3.7	4.0	4.2	4.4	4.6	4.9	5.1	5.3	5.5	5.8	6.0	6.2	6.4	6.6	6.9

Applicable Controllers

The RCP5 series actuators can be operated by the controllers indicated below. Please select the type depending on your intended use.

Name	External view	Model number	Max. number of controlled axes	Maximum number of positioning points	Input power	Standard price	Reference page
Positioner type (High-output specification)		PCON-CA-56PWAI-①-2-0	1	512 points	DC24V	-	→P.69
Pulse train type (High-output specification)		PCON-CA-56PWAI-PL②-2-0					
Network type (High-output specification)		PCON-CA-56PWAI-③-0-0					
Solenoid valve multi-axis type (PIO specification)		MSEP-④-⑤-⑥-⑦-⑧-⑨-⑩-2-0	4 (4 when high-output enabled) LC: 6 (3 when high-output enabled)	3 points	-	-	→P.77
Solenoid valve multi-axis type (Network specification)		MSEP-④-⑤-⑥-⑦-⑧-⑨-⑩-0-0					
Program control multi-axis type		MSEL-PC-1-56PWAI-⑪-2-4	4	30,000 points	Single-phase AC 100V~230V	-	→P.87
Program control multi-axis type (w/network board)		MSEL-PC-1-56PWAI-⑫-0-4					
Program control multi-axis type (Safety category compliant spec.)		MSEL-PG-1-56PWAI-⑬-2-4					
Program control multi-axis type (Safety category compliant spec. w/network board)		MSEL-PG-1-56PWAI-⑭-0-4					

*Above MSEL models are for single-axis specification *① I/O type (NP/PN) *② Number of axes
 *③ Field network specification code *④ C or LC *⑤ N (NPN specification) or P (PNP specification) code
 *The high output enabled operation is only available when the "High-output setting specs" is selected in the MSEP-C/LC.

RCP5-SA4R ROBO Cylinder, Slider Type, Side-mounted Motor Type, Actuator Width 40mm, 24V Pulse Motor

Model	RCP5	SA4R	WA	35P			P3		
Specification Items	Series	Type	Encoder type	Motor type	Lead	Stroke	Applicable controllers	Cable length	Options
			WA: Battery-less absolute specification	35P: Pulse motor, size 35□	16: 16mm 10: 10mm 5: 5mm 2.5: 2.5mm	50: 50mm 500: 500mm (Every 50mm)	P3: PCON-CA MSEP MSEL	N: No cable P: 1m S: 3m M: 5m X□: Specified length R□: Robot cable	Please refer to the options table below.

*Controller is not included.

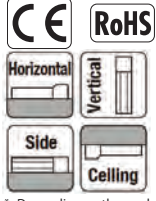

* Depending on the model, there may be some limitations to using the vertical, side, and ceiling mount positions. Please refer to P.59 for details.



The figure above is the motor side-mounted to the left (ML).

POINT
Note on selection

(1) The actuator specification displays the payload's maximum value, but it will vary depending on the acceleration. Please refer to the "Selection Guidelines" (RCP5 Payload by Speed/Acceleration Table) on P. 61.
(2) Please refer to P. 59 for push-motion operation.

Correlation Diagrams of Speed and Payload

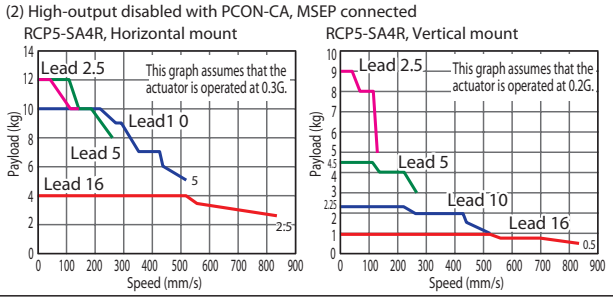
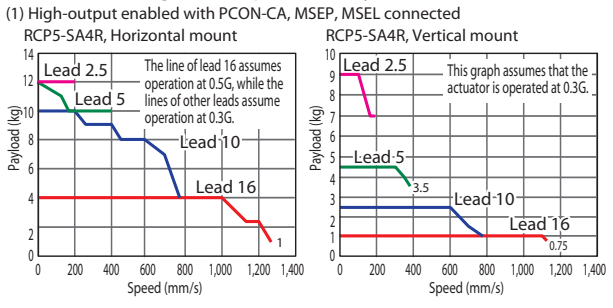

Actuator Specifications

Lead and Payload

Model number	Lead (mm)	Connected controller	Maximum payload		Stroke (mm)
			Horizontal (kg)	Vertical (kg)	
RCP5-SA4R-WA-35P-16-①-P3-②-③	16	High-output enabled	4	1	50~500 (Every 50mm)
		High-output disabled			
RCP5-SA4R-WA-35P-10-①-P3-②-③	10	High-output enabled	10	2.25	
		High-output disabled			
RCP5-SA4R-WA-35P-5-①-P3-②-③	5	High-output enabled	12	4.5	
		High-output disabled			
RCP5-SA4R-WA-35P-2.5-①-P3-②-③	2.5	High-output enabled	12	9	
		High-output disabled			

Legend: ① Stroke ② Cable length ③ Options *Please refer to P.59 for push-motion operation.

Stroke and Maximum Speed

Lead (mm)	Connected controller	Maximum speed (Unit: mm/s)		
		50~400 (Every 50mm)	450 (mm)	500 (mm)
16	High-output enabled	1,260	1,060	875
	High-output disabled	840		
10	High-output enabled	785	675	555
	High-output disabled	525		
5	High-output enabled	390	330	275
	High-output disabled	260		
2.5	High-output enabled	195	165	135
	High-output disabled	130		

① Stroke

Stroke (mm)	Standard price	Stroke (mm)	Standard price
50	-	300	-
100	-	350	-
150	-	400	-
200	-	450	-
250	-	500	-

② Cable Length

Type	Cable code	Standard price
Standard type	P (1m)	-
	S (3m)	-
	M (5m)	-
Special length	X06 (6m) ~X10 (10m)	-
	X11 (11m)~X15 (15m)	-
	X16 (16m)~X20 (20m)	-
		-
Robot cable	R01 (1m) ~R03 (3m)	-
	R04 (4m) ~R05 (5m)	-
	R06 (6m) ~R10 (10m)	-
	R11 (11m)~R15 (15m)	-
	R16 (16m)~R20 (20m)	-
		-
		-
		-

*Please refer to P. 89 for maintenance cables.

③ Options

Name	Option code	Reference page	Standard price
Brake	B	→P. 11	-
Cable exit direction (Top)	CJT	→P. 11	-
Cable exit direction (Outside)	CJO	→P. 11	-
Cable exit direction (Bottom)	CJB	→P. 11	-
Motor side-mounted to the left (Standard)	ML	→P. 11	-
Motor side-mounted to the right	MR	→P. 11	-
Slider roller specification	SR	→P. 11	-
Non-motor end specification	NM	→P. 11	-

Actuator Specifications

Item	Description
Drive system	Ball screw Ø8mm, rolled C10
Positioning repeatability	±0.02mm
Lost motion	0.1mm or less
Base	Material: Aluminum with white alumite treatment
Dynamic allowable moment (*1)	Ma: 4.98N·m, Mb: 7.11N·m, Mc: 9.68N·m
Static allowable moment	Ma: 8.6N·m, Mb: 12.2N·m, Mc: 16.7N·m
Ambient operating temperature, humidity	0 to 40°C, 85% RH or less (Non-condensing)

*Reference for overhang load length/Ma: 120mm or less, Mb, Mc: 120mm or less (*1) Assumes a standard rated life of 5,000km.

(*) The operational life will vary depending on operation and installation conditions. Please refer to the general catalog for details on operational life, allowable moment direction, and overhang load length.

Dimensions

CAD drawings can be downloaded from our website. www.intelligentactuator.com



- *1 When the slider is returning to its home position, please be careful of interference from surrounding objects, as it will travel until it reaches the ME.
- ME: Mechanical end
- SE: Stroke end
- *2 Please see P.48 for slider roller specification (SR).

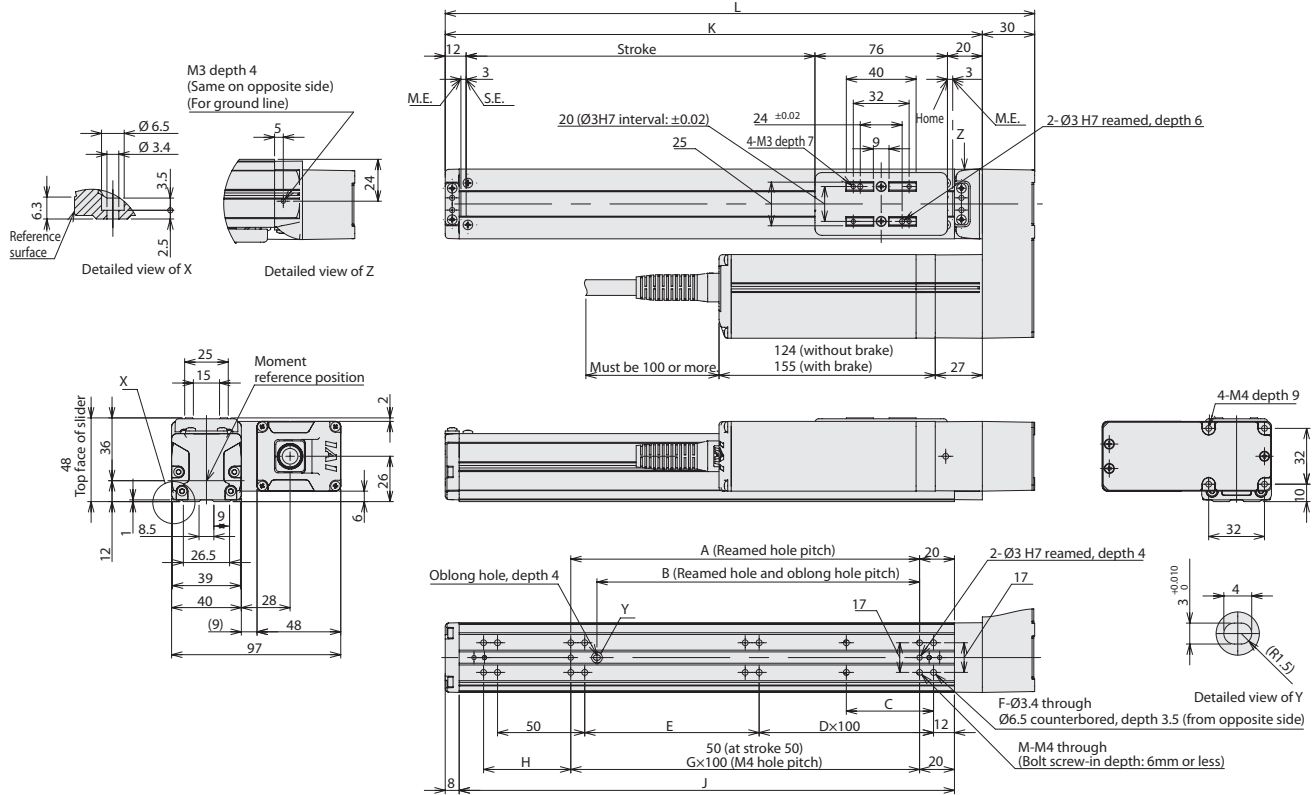

■ Cable Exit Direction (Option)

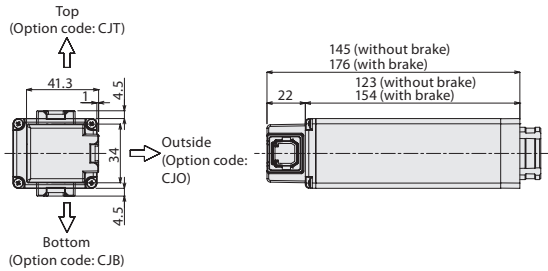

*The figure above is for the motor side-mounted to the left (ML).

■ Dimensions and Mass by Stroke

Stroke	50	100	150	200	250	300	350	400	450	500	
L	188	238	288	338	388	438	488	538	588	638	
A	50	100	100	200	200	300	300	400	400	500	
B	35	85	85	185	185	285	285	385	385	485	
C	25	50	50	50	50	50	50	50	50	50	
D	0	0	1	1	2	2	3	3	4	4	
E	50	100	50	100	50	100	50	100	50	100	
F	8	8	10	10	12	12	14	14	16	16	
G	-	1	1	2	2	3	3	4	4	5	
H	50	50	100	50	100	50	100	50	100	50	
J	134	184	234	284	334	384	434	484	534	584	
K	158	208	258	308	358	408	458	508	558	608	
M	6	6	6	8	8	10	10	12	12	14	
Mass (kg)	Without brake	1.3	1.4	1.5	1.6	1.6	1.7	1.8	1.9	2.0	2.1
	With brake	1.5	1.6	1.7	1.8	1.8	1.9	2.0	2.1	2.2	2.3

Applicable Controllers

The RCP5 series actuators can be operated by the controllers indicated below. Please select the type depending on your intended use.

Name	External view	Model number	Max. number of controlled axes	Maximum number of positioning points	Input power	Standard price	Reference page
Positioner type (High-output specification)		PCON-CA-35PWAI-①-2-0	1	512 points	DC24V	-	→P.69
Pulse train type (High-output specification)		PCON-CA-35PWAI-PL②-2-0				-	
Network type (High-output specification)		PCON-CA-35PWAI-③-0-0				-	
Solenoid valve multi-axis type (PIO specification)		MSEP-④-⑤-⑥-⑦-⑧-⑨-⑩-2-0	4 (when high-output enabled) LC: 6 (3 when high-output enabled)	3 points	Single-phase AC 100V~230V	-	→P.77
Solenoid valve multi-axis type (Network specification)		MSEP-④-⑤-⑥-⑦-⑧-⑨-⑩-0-0				256 points	
Program control multi-axis type		MSEL-PC-1-35PWAI-①-2-4	4	30,000 points	Single-phase AC 100V~230V	-	→P.87
Program control multi-axis type (w/network board)		MSEL-PC-1-35PWAI-②-0-4				-	
Program control multi-axis type (Safety category compliant spec.)		MSEL-PG-1-35PWAI-③-2-4				-	
Program control multi-axis type (Safety category compliant spec. w/network board)		MSEL-PG-1-35PWAI-④-0-4				-	

*Above MSEL models are for single-axis specification *① I/O type (NP/PN) *② Number of axes
 *③ Field network specification code *④ C or LC *⑤ N (NPN specification) or P (PNP specification) code
 *The high output enabled operation is only available when the "High-output setting specs" is selected in the MSEP-C/LC.

RCP5-SA6R ROBO Cylinder, Slider Type, Side-mounted Motor Type, Actuator Width 58mm, 24V Pulse Motor

Model	RCP5	SA6R	WA	42P			P3		
Specification Items	Series	Type	Encoder type	Motor type	Lead	Stroke	Applicable controllers	Cable length	Options
			WA: Battery-less absolute specification	42P: Pulse motor, size 42□	20: 20mm 12: 12mm 6: 6mm 3: 3mm	50: 50mm 800: 800mm (Every 50mm)	P3: PCON-CA MSEP MSEL	N: No cable P: 1m S: 3m M: 5m X□: Specified length R□: Robot cable	Please refer to the options table below.

*Controller is not included.

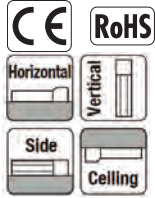

* Depending on the model, there may be some limitations to using the vertical, side, and ceiling mount positions. Please refer to P.59 for details.

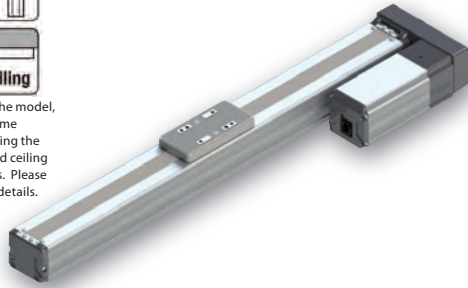

The figure above is the motor side-mounted to the left (ML).

POINT
Note on selection

(1) The actuator specification displays the payload's maximum value, but it will vary depending on the acceleration. Please refer to the "Selection Guidelines" (RCP5 Payload by Speed/Acceleration Table) on P. 61.

(2) Please refer to P. 59 for push-motion operation.

Correlation Diagrams of Speed and Payload

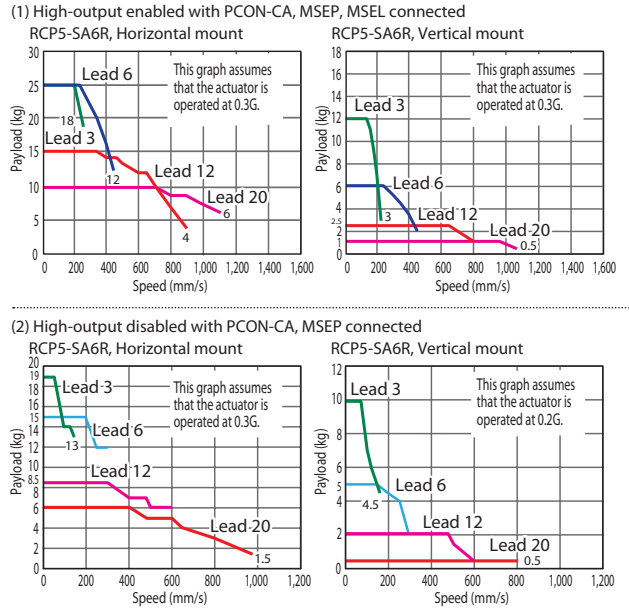

Actuator Specifications

Lead and Payload

Model number	Lead (mm)	Connected controller	Maximum payload		Stroke (mm)
			Horizontal (kg)	Vertical (kg)	
RCP5-SA6R-WA-42P-20-①-P3-②-③	20	High-output enabled	10	1	50~800 (Every 50mm)
			High-output disabled	6	
RCP5-SA6R-WA-42P-12-①-P3-②-③	12	High-output enabled	15	2.5	
			High-output disabled	8.5	
RCP5-SA6R-WA-42P-6-①-P3-②-③	6	High-output enabled	25	6	
			High-output disabled	16	
RCP5-SA6R-WA-42P-3-①-P3-②-③	3	High-output enabled	25	12	
			High-output disabled	19	

Legend: ① Stroke ② Cable length ③ Options *Please refer to P.59 for push-motion operation.

Stroke and Maximum Speed

Values in brackets <> are for vertical use. (Unit: mm/s)

Lead (mm)	Connected controller	50~400	450	500	550	600	650	700	750	800
		(Every 50mm)	(mm)	(mm)	(mm)	(mm)	(mm)	(mm)	(mm)	(mm)
20	High-output enabled		1,280		1,130	970	840	735	650	575
	High-output disabled		960				840	735	650	575
12	High-output enabled	900 <800>	885 <800>	735	620	535	460	405	355	315
	High-output disabled		600			535	460	405	355	315
6	High-output enabled	450	435	365	305	265	230	200	175	155
	High-output disabled		300			265	230	200	175	155
3	High-output enabled	225	215	180	150	130	115	100	85	75
	High-output disabled		150			130	115	100	85	75

① Stroke

Stroke (mm)	Standard price	Stroke (mm)	Standard price
50	-	450	-
100	-	500	-
150	-	550	-
200	-	600	-
250	-	650	-
300	-	700	-
350	-	750	-
400	-	800	-

② Cable Length

Type	Cable code	Standard price
Standard type	P (1m)	-
	S (3m)	-
	M (5m)	-
Special length	X06 (6m) ~X10 (10m)	-
	X11 (11m)~X15 (15m)	-
	X16 (16m)~X20 (20m)	-
	R01 (1m) ~R03 (3m)	-
Robot cable	R04 (4m) ~R05 (5m)	-
	R06 (6m) ~R10 (10m)	-
	R11 (11m)~R15 (15m)	-
	R16 (16m)~R20 (20m)	-

*Please refer to P.89 for maintenance cables.

③ Options

Name	Option code	Reference page	Standard price
Brake	B	→P. 11	-
Cable exit direction (Top)	CJT	→P. 11	-
Cable exit direction (Outside)	CJO	→P. 11	-
Cable exit direction (Bottom)	CJB	→P. 11	-
Motor side-mounted to the left (Standard)	ML	→P. 11	-
Motor side-mounted to the right	MR	→P. 11	-
Slider roller specification	SR	→P. 11	-
Non-motor end specification	NM	→P. 11	-

Actuator Specifications

Item	Description
Drive system	Ball screw Ø10mm, rolled C10
Positioning repeatability (*1)	±0.02mm [±0.03mm]
Lost motion	0.1mm or less
Base	Material: Aluminum with white alumite treatment
Dynamic allowable moment (*2)	Ma: 11.6N·m, Mb: 16.6N·m, Mc: 24.6N·m
Static allowable moment	Ma: 38.3N·m, Mb: 54.7N·m, Mc: 81N·m
Ambient operating temperature, humidity	0 to 40°C, 85% RH or less (Non-condensing)

*Reference for overhang load length/Ma: 150mm or less, Mb, Mc: 150mm or less

(*1) The values in brackets [] are for Lead 20.

(*2) Assumes a standard rated life of 5,000km.

(*) The operational life will vary depending on operation and installation conditions. Please refer to the general catalog for details on operational life, allowable moment direction, and overhang load length.

Dimensions

CAD drawings can be downloaded from our website. www.intelligentactuator.com



- *1 When the slider is returning to its home position, please be careful of interference from surrounding objects, as it will travel until it reaches the ME.
- ME: Mechanical end
- SE: Stroke end
- *2 Please see P.50 for slider roller specification (SR).

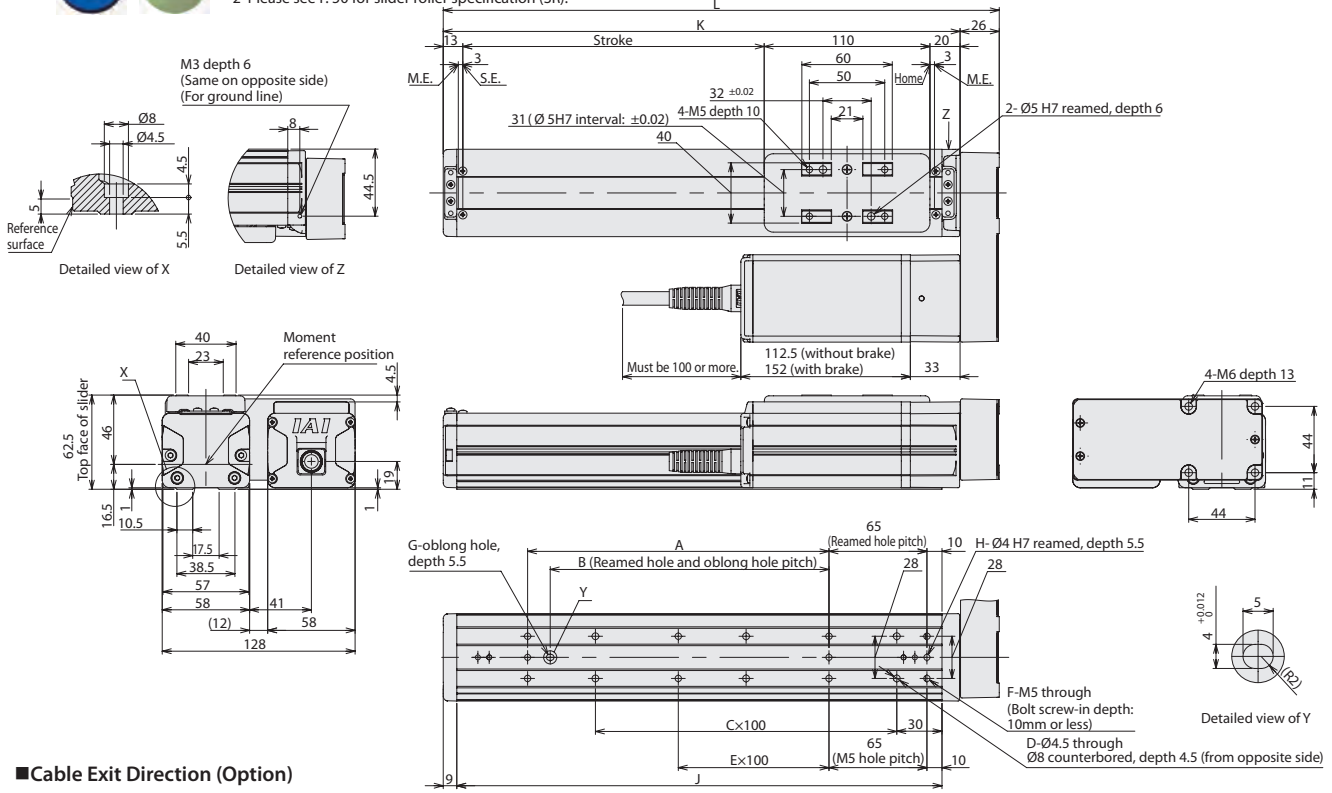

■ Cable Exit Direction (Option)

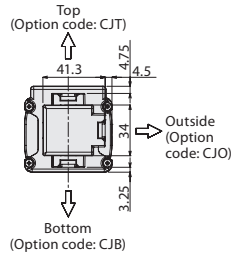

*The figure above is for the motor side-mounted to the left (ML).

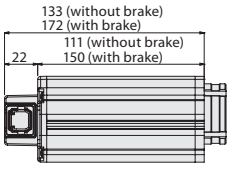

■ Dimensions and Mass by Stroke

Stroke	50	100	150	200	250	300	350	400	450	500	550	600	650	700	750	800
L	219	269	319	369	419	469	519	569	619	669	719	769	819	869	919	969
A	0	100	100	200	200	300	300	400	400	500	500	600	600	700	700	800
B	0	85	85	185	185	285	285	385	385	485	485	585	585	685	685	785
C	1	1	2	2	3	3	4	4	5	5	6	6	7	7	8	8
D	4	4	6	6	8	8	10	10	12	12	14	14	16	16	18	18
E	0	0	0	1	1	2	2	3	3	4	4	5	5	6	6	7
F	4	6	6	8	8	10	10	12	12	14	14	16	16	18	18	20
G	0	1	1	1	1	1	1	1	1	1	1	1	1	1	1	1
H	2	3	3	3	3	3	3	3	3	3	3	3	3	3	3	3
J	172	222	272	322	372	422	472	522	572	622	672	722	772	822	872	922
K	193	243	293	343	393	443	493	543	593	643	693	743	793	843	893	943
Mass (kg)	Without brake	2.1	2.2	2.4	2.6	2.8	2.9	3.1	3.3	3.5	3.6	3.8	4.0	4.2	4.3	4.5
	With brake	2.3	2.4	2.6	2.8	3.0	3.1	3.3	3.5	3.7	3.8	4.0	4.2	4.4	4.5	4.7

Applicable Controllers

The RCP5 series actuators can be operated by the controllers indicated below. Please select the type depending on your intended use.

Name	External view	Model number	Max. number of controlled axes	Maximum number of positioning points	Input power	Standard price	Reference page
Positioner type (High-output specification)		PCON-CA-42PWAI-①-2-0	1	512 points	DC24V	-	→P.69
Pulse train type (High-output specification)		PCON-CA-42PWAI-PL②-2-0				-	
Network type (High-output specification)		PCON-CA-42PWAI-③-0-0				-	
Solenoid valve multi-axis type (PIO specification)		MSEP-④-⑤-⑥-⑦-⑧-⑨-⑩-2-0	4 (4 when high-output enabled) LC: 6 (3 when high-output enabled)	3 points	Single-phase AC 100V~230V	-	→P.77
Solenoid valve multi-axis type (Network specification)		MSEP-④-⑤-⑥-⑦-⑧-⑨-⑩-0-0				256 points	
Program control multi-axis type		MSEL-PC-1-42PWAI-⑪-2-4	4	30,000 points	Single-phase AC 100V~230V	-	→P.87
Program control multi-axis type (w/network board)		MSEL-PC-1-42PWAI-⑫-0-4					
Program control multi-axis type (Safety category compliant spec.)		MSEL-PG-1-42PWAI-⑬-2-4					
Program control multi-axis type (Safety category compliant spec. w/network board)		MSEL-PG-1-42PWAI-⑭-0-4					

*Above MSEL models are for single-axis specification
 *① I/O type (NP/PN)
 *② Field network specification code
 *③ Number of axes
 *④ C or LC
 *⑤ N (NPN specification) or P (PNP specification) code
 *The high output enabled operation is only available when the "High-output setting specs" is selected in the MSEP-C/LC.

RCP5-SA7R ROBO Cylinder, Slider Type, Side-mounted Motor Type, Actuator Width 73mm, 24V Pulse Motor

Model	RCP5	SA7R	WA	56P			P3		
Specification Items	Series	Type	Encoder type	Motor type	Lead	Stroke	Applicable controllers	Cable length	Options
			WA: Battery-less absolute specification	56P: Pulse motor, size 56□	24: 24mm 16: 16mm 8: 8mm 4: 4mm	50: 50mm 800: 800mm (Every 50mm)	P3: PCON-CA MSEP MSEL	N: No cable P: 1m S: 3m M: 5m X□: Specified length R□: Robot cable	Please refer to the options table below.

*Controller is not included.



* Depending on the model, there may be some limitations to using the vertical, side, and ceiling mount positions. Please refer to P.59 for details.

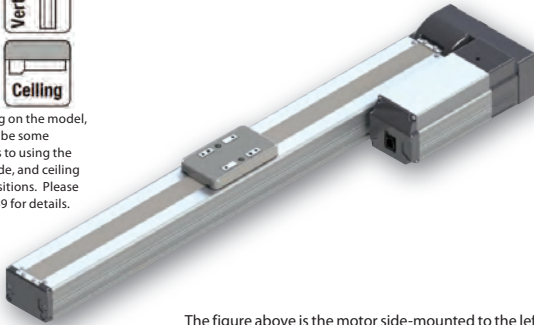

The figure above is the motor side-mounted to the left (ML).

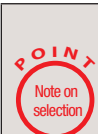

- The actuator specification displays the payload's maximum value, but it will vary depending on the acceleration. Please refer to the "Selection Guidelines" (RCP5 Payload by Speed/Acceleration Table) on P. 61.
- Please refer to P. 59 for push-motion operation.

Correlation Diagrams of Speed and Payload

(1) High-output enabled with PCON-CA, MSEP, MSEL connected

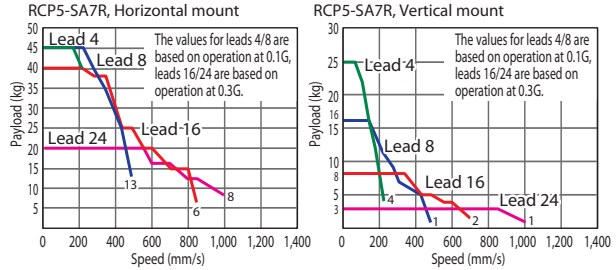

(2) High-output disabled with PCON-CA, MSEP connected

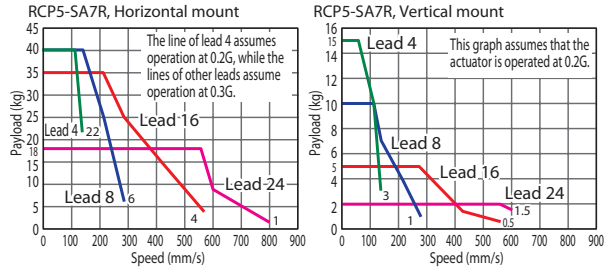

Actuator Specifications

Lead and Payload

Model number	Lead (mm)	Connected controller	Maximum payload		Stroke (mm)
			Horizontal (kg)	Vertical (kg)	
RCP5-SA7R-WA-56P-24-①-P3-②-③	24	High-output enabled	20	3	50~800 (Every 50mm)
		High-output disabled	18	2	
RCP5-SA7R-WA-56P-16-①-P3-②-③	16	High-output enabled	40	8	
		High-output disabled	35	5	
RCP5-SA7R-WA-56P-8-①-P3-②-③	8	High-output enabled	45	16	
		High-output disabled	40	10	
RCP5-SA7R-WA-56P-4-①-P3-②-③	4	High-output enabled	45	25	
		High-output disabled	40	15	

Legend: ① Stroke ② Cable length ③ Options *Please refer to P. 59 for push-motion operation.

① Stroke

Stroke (mm)	Standard price	Stroke (mm)	Standard price
50	-	450	-
100	-	500	-
150	-	550	-
200	-	600	-
250	-	650	-
300	-	700	-
350	-	750	-
400	-	800	-

② Cable Length

Type	Cable code	Standard price	Type	Cable code	Standard price
Standard type	P (1m)	-	Robot cable	R01 (1m) ~R03 (3m)	-
	S (3m)	-		R04 (4m) ~R05 (5m)	-
	M (5m)	-		R06 (6m) ~R10 (10m)	-
Special length	X06 (6m) ~X10 (10m)	-		R11 (11m)~R15 (15m)	-
	X11 (11m)~X15 (15m)	-		R16 (16m)~R20 (20m)	-
	X16 (16m)~X20 (20m)	-			

*Please refer to P.89 for maintenance cables.

Stroke and Maximum Speed

Values in brackets <> are for vertical use. (Unit: mm/s)

Lead (mm)	Connected controller	50~550 (Every 50mm)	600 (mm)	650 (mm)	700 (mm)	750 (mm)	800 (mm)
24	High-output enabled	1,000				885	785
	High-output disabled	800 <600>				785 <600>	
16	High-output enabled	840 <700>	755 <700>	660	585	520	
	High-output disabled	560				520	
8	High-output enabled	490	430	375	325	290	255
	High-output disabled	280				255	
4	High-output enabled	210	185	160	140	125	
	High-output disabled	140				125	

③ Options

Name	Option code	Reference page	Standard price
Brake	B	→P. 11	-
Cable exit direction (Top)	CJT	→P. 11	-
Cable exit direction (Outside)	CJO	→P. 11	-
Cable exit direction (Bottom)	CJB	→P. 11	-
Motor side-mounted to the left (Standard)	ML	→P. 11	-
Motor side-mounted to the right	MR	→P. 11	-
Non-motor end specification	NM	→P. 11	-
Slider roller specification	SR	→P. 11	-
Slider spacer	SS	→P. 11	-

Actuator Specifications

Item	Description
Drive system	Ball screw Ø12mm, rolled C10
Positioning repeatability (*1)	±0.02mm [±0.03mm]
Lost motion	0.1mm or less
Base	Material: Aluminum with white alumite treatment
Dynamic allowable moment (*2)	Ma: 11.6N·m, Mb: 16.6N·m, Mc: 33.7N·m
Static allowable moment	Ma: 51.2N·m, Mb: 73.1N·m, Mc: 148N·m
Ambient operating temperature, humidity	0 to 40°C, 85% RH or less (Non-condensing)

*Reference for overhang load length/Ma: 230mm or less, Mb, Mc: 230mm or less

(*1) The values in brackets [] are for Lead 24.

(*2) Assumes a standard rated life of 5,000km.

(*) The operational life will vary depending on operation and installation conditions. Please refer to the general catalog for details on operational life, allowable moment direction, and overhang load length.

Dimensions

CAD drawings can be downloaded from our website. www.intelligentactuator.com

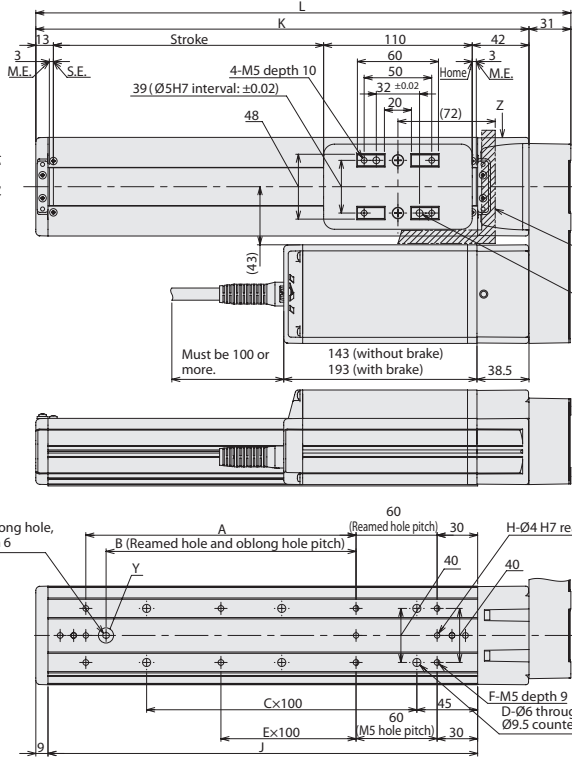
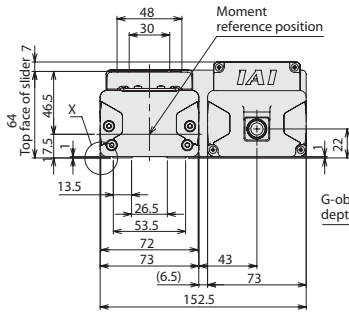
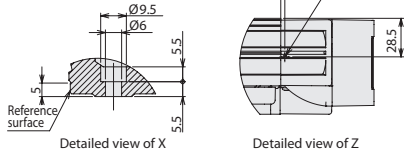

*1 When the slider is returning to its home position, please be careful of interference from surrounding objects, as it will travel until it reaches the ME.
ME: Mechanical end
SE: Stroke end
*2 Please see P.52 for slider roller specification (SR).

Work part installed on the slider
Pay attention to interference.

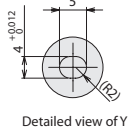
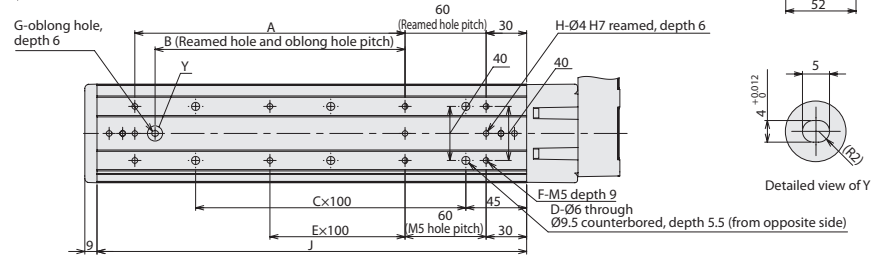
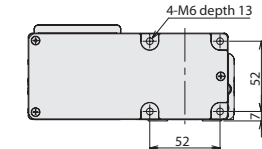

■ Cable Exit Direction (Option)

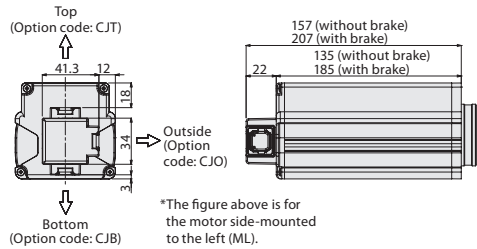

*The figure above is for the motor side-mounted to the left (ML).

■ Slider Spacer (Option)

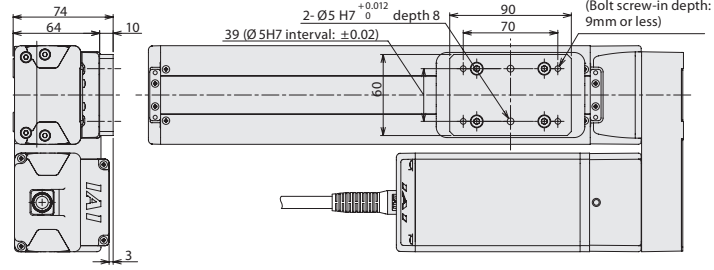

■ Dimensions and Mass by Stroke

Stroke	50	100	150	200	250	300	350	400	450	500	550	600	650	700	750	800	
L	246	296	346	396	446	496	546	596	646	696	746	796	846	896	946	996	
A	0	100	100	200	200	300	300	400	400	500	500	600	600	700	700	800	
B	0	85	85	185	185	285	285	385	385	485	485	585	585	685	685	785	
C	1	1	2	2	3	3	4	4	5	5	6	6	7	7	8	8	
D	4	4	6	6	8	8	10	10	12	12	14	14	16	16	18	18	
E	0	0	0	1	1	2	2	3	3	4	4	5	5	6	6	7	
F	4	6	6	8	8	10	10	12	12	14	14	16	16	18	18	20	
G	0	1	1	1	1	1	1	1	1	1	1	1	1	1	1	1	
H	2	3	3	3	3	3	3	3	3	3	3	3	3	3	3	3	
J	168	218	268	318	368	418	468	518	568	618	668	718	768	818	868	918	
K	215	265	315	365	415	465	515	565	615	665	715	765	815	865	915	965	
Mass (kg)	Without brake	3.7	3.9	4.2	4.4	4.6	4.8	5.1	5.3	5.5	5.7	6.0	6.2	6.4	6.6	6.8	7.1
	With brake	4.2	4.4	4.7	4.9	5.1	5.3	5.6	5.8	6.0	6.2	6.5	6.7	6.9	7.1	7.3	7.6

Applicable Controllers

The RCP5 series actuators can be operated by the controllers indicated below. Please select the type depending on your intended use.

Name	External view	Model number	Max. number of controlled axes	Maximum number of positioning points	Input power	Standard price	Reference page
Positioner type (High-output specification)		PCON-CA-56PWAI-①-2-0	1	512 points	DC24V	-	→P.69
Pulse train type (High-output specification)		PCON-CA-56PWAI-PL②-2-0				-	
Network type (High-output specification)		PCON-CA-56PWAI-③-0-0				-	
Solenoid valve multi-axis type (PIO specification)		MSEP-④-⑤-⑥-⑦-⑧-2-0	C: 8 (4 when high-output enabled) LC: 6 (3 when high-output enabled)	3 points	Single-phase AC 100V~230V	-	→P.77
Solenoid valve multi-axis type (Network specification)		MSEP-④-⑤-⑥-⑦-⑧-0-0				256 points	
Program control multi-axis type		MSEL-PC-1-56PWAI-①-2-4	4	30,000 points	Single-phase AC 100V~230V	-	→P.87
Program control multi-axis type (w/network board)		MSEL-PC-1-56PWAI-②-0-4					
Program control multi-axis type (Safety category compliant spec.)		MSEL-PG-1-56PWAI-③-2-4					
Program control multi-axis type (Safety category compliant spec. w/network board)		MSEL-PG-1-56PWAI-④-0-4					

*Above MSEL models are for single-axis specification
 *① I/O type (NP/PN)
 *② Field network specification code
 *③ C or LC
 *④ Number of axes
 *⑤ N (NPN specification) or P (PNP specification) code
 *The high output enabled operation is only available when the "High-output setting specs" is selected in the MSEP-C/LC.

RCP5-RA4C ROBO Cylinder, Rod Type, Motor Unit Coupled, Actuator Width 40mm, 24V Pulse Motor

Model	RCP5	RA4C	WA	35P			P3		
Specification	Series	Type	Encoder type	Motor type	Lead	Stroke	Applicable controllers	Cable length	Options
Items			WA: Battery-less absolute specification	35P: Pulse motor, size 35□	16: 16mm 10: 10mm 5: 5mm 2.5: 2.5mm	60: 60mm 410: 410mm (Every 50mm)	P3: PCON-CA MSEP MSEL	N: No cable P: 1m S: 3m M: 5m X□: Specified length R□: Robot cable	Please refer to the options table below.

*Controller is not included.

Radial Load Applicable

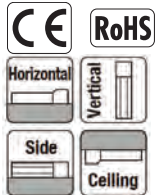

* Depending on the model, there may be some limitations to using the vertical mount position. Please refer to P.59 for details.



- POINT**
Note on selection
- The actuator specification displays the payload's maximum value, but it will vary depending on the acceleration. Please refer to the "Selection Guidelines" (RCP5 Payload by Speed/Acceleration Table) on P. 61.
 - Please refer to P. 59 for push-motion operation.
 - The radial cylinder is equipped with a built-in guide. Please refer to the graphs shown in P. 65 and after for the allowable load mass.

Correlation Diagrams of Speed and Payload

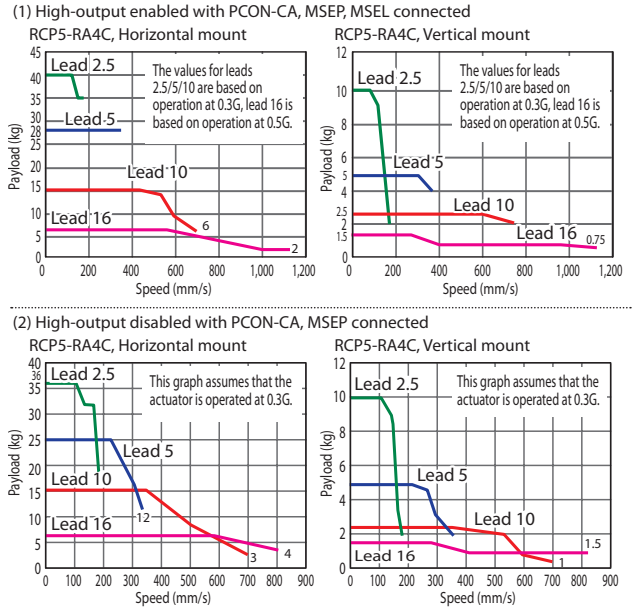

Actuator Specifications

Lead and Payload

Model number	Lead (mm)	Connected controller	Maximum payload		Maximum push force (N)	Stroke (mm)
			Horizontal (kg)	Vertical (kg)		
RCP5-RA4C-WA-35P-16-①-P3-②-③	16	High-output enabled	6	1.5	48	60~410 (Every 50mm)
		High-output disabled				
RCP5-RA4C-WA-35P-10-①-P3-②-③	10	High-output enabled	15	2.5	77	
		High-output disabled				
RCP5-RA4C-WA-35P-5-①-P3-②-③	5	High-output enabled	28	5	155	
		High-output disabled				
RCP5-RA4C-WA-35P-2.5-①-P3-②-③	2.5	High-output enabled	40	10	310	
		High-output disabled	36			

Legend: ① Stroke ② Cable length ③ Options *Please refer to P. 59 for push-motion operation.

Stroke and Maximum Speed

(Unit: mm/s)

Lead (mm)	Connected controller	60~360 (Every 50mm)	410 (mm)
16	High-output enabled	1,120	1,080
	High-output disabled	840	
10	High-output enabled	700	685
	High-output disabled		
5	High-output enabled	350	340
	High-output disabled		
2.5	High-output enabled	175	170
	High-output disabled		

① Stroke

Stroke (mm)	Standard price
60	-
110	-
160	-
210	-
260	-
310	-
360	-
410	-

③ Options

Name	Option code	Reference page	Standard price
Brake	B	→P. 11	-
Cable exit direction (Top)	CJT	→P. 11	-
Cable exit direction (Right)	CJR	→P. 11	-
Cable exit direction (Left)	CJL	→P. 11	-
Cable exit direction (Bottom)	CJB	→P. 11	-
Flange	FL	→P. 12	-
Tip adapter (Flange)	FFA	→P. 12	-
Tip adapter (Internal thread)	NFA	→P. 13	-
Tip adapter (Keyway)	KFA	→P. 13	-
Non-motor end specification	NM	→P. 11	-

② Cable Length

Type	Cable code	Standard price
Standard type	P (1m)	-
	S (3m)	-
	M (5m)	-
Special length	X06 (6m) ~X10 (10m)	-
	X11 (11m)~X15 (15m)	-
	X16 (16m)~X20 (20m)	-
	R01 (1m) ~R03 (3m)	-
Robot cable	R04 (4m) ~R05 (5m)	-
	R06 (6m) ~R10 (10m)	-
	R11 (11m)~R15 (15m)	-
	R16 (16m)~R20 (20m)	-

*Please refer to P. 89 for maintenance cables.

Actuator Specifications

Item	Description
Drive system	Ball screw Ø8mm, rolled C10
Positioning repeatability	±0.02mm
Lost motion	0.1mm or less
Rod	Ø20mm Aluminum
Rod non-rotation precision (*1)	0 deg.
Allowable load and torque on rod tip	Refer to table in the page on the right, refer to P. 65
Rod tip overhang distance	100mm or less
Ambient operating temperature, humidity	0 to 40°C, 85% RH or less (Non-condensing)

(*1) Rod's angular displacement in rotational direction with no applied load is shown.

Dimensions

CAD drawings can be downloaded from our website. www.intelligentactuator.com



- *1 When the rod is returning to its home position, please be careful of interference from surrounding objects, as it will travel until it reaches the ME.
 - *2 The direction of width across flats varies depending on the product.
 - *3 If the actuator is installed using the front housing and flange, make sure the actuator will not receive any external force.
- ME: Mechanical end
SE: Stroke end

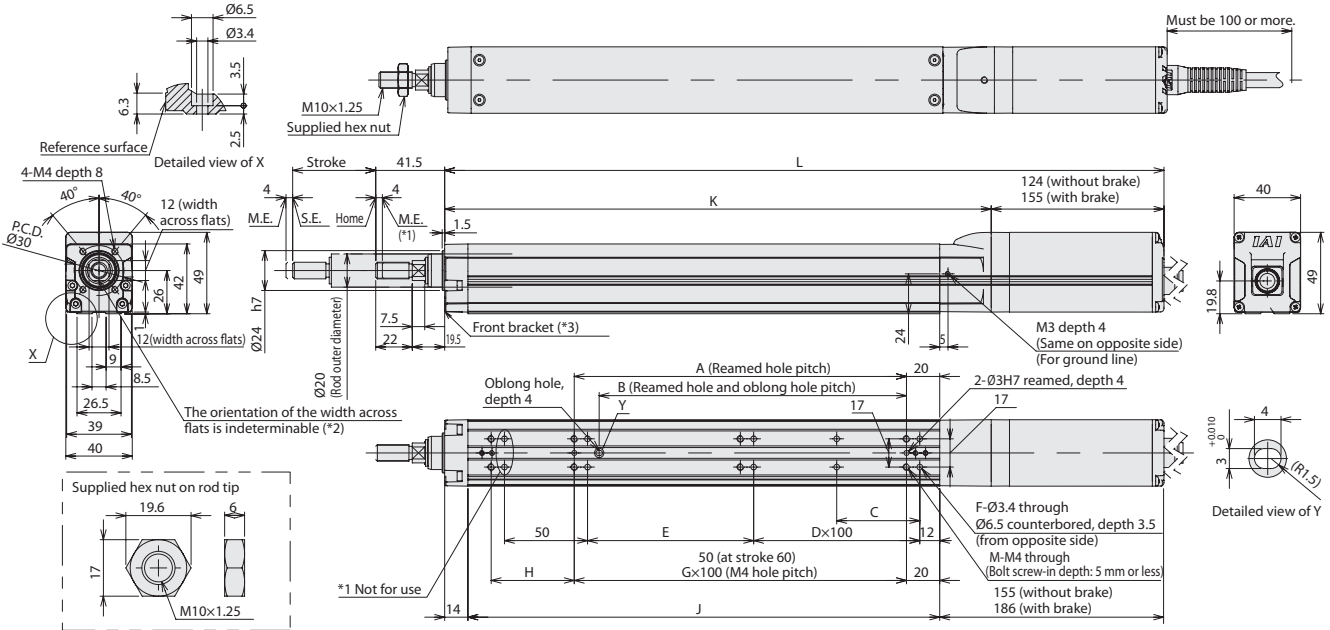

*1 Two mounting holes on the rod side of the top of the base cannot be used.

■ Cable Exit Direction (Option)

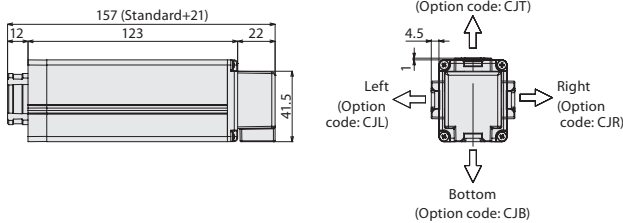

■ Rod Deflection of RCP5-RA4C (Reference Values)

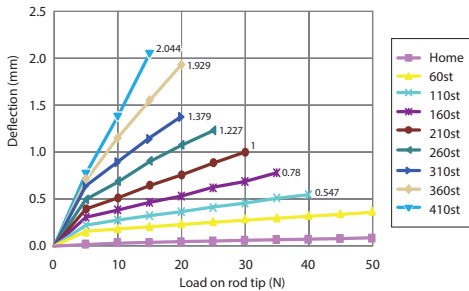

■ Dimensions and Mass by Stroke

L	Stroke		60	110	160	210	260	310	360	410
		Without brake	With brake	303	353	403	453	503	553	603
A	50	100	100	200	200	300	300	400	400	400
B	35	85	85	185	185	285	285	385	385	385
C	25	50	50	50	50	50	50	50	50	50
D	0	0	1	1	2	2	3	3	3	3
E	50	100	50	100	50	100	50	100	50	100
F	8	8	10	10	12	12	14	14	14	14
G	-	1	1	2	2	3	3	4	4	4
H	50	50	100	50	100	50	100	50	100	50
J	134	184	234	284	334	384	434	484	484	484
K	179	229	279	329	379	429	479	529	529	529
M	6	6	6	8	8	10	10	12	12	12
Allowable static load on rod tip (N)			55.8	44.6	37.1	31.7	27.6	24.3	21.7	19.5
Allowable dynamic load on rod tip (N)			25.4	19.5	15.5	12.8	10.8	9.2	7.9	6.9
Load offset 100mm			16.5	14.5	12.4	10.7	9.2	8.0	7.0	6.2
Allowable static torque on rod tip (N-m)			5.6	4.5	3.8	3.2	2.8	2.5	2.3	2.1
Allowable dynamic torque on rod tip (N-m)			1.7	1.5	1.2	1.1	0.9	0.8	0.7	0.6
Mass (kg)			1.1	1.2	1.3	1.4	1.6	1.7	1.8	1.9
Without brake			1.1	1.2	1.3	1.4	1.6	1.7	1.8	1.9
With brake			1.3	1.4	1.5	1.6	1.8	1.9	2.0	2.1

Applicable Controllers

The RCP5 series actuators can be operated by the controllers indicated below. Please select the type depending on your intended use.

Name	External view	Model number	Max. number of controlled axes	Maximum number of positioning points	Input power	Standard price	Reference page
Positioner type (High-output specification)		PCON-CA-35PWAI-①-2-0	1	512 points	DC24V	-	→P. 69
Pulse train type (High-output specification)		PCON-CA-35PWAI-PL⑤-2-0					
Network type (High-output specification)		PCON-CA-35PWAI-③-0-0					
Solenoid valve multi-axis type (PIO specification)		MSEP-④-①-①-①-①-2-0	4 (when high-output enabled) LC: 6 (3 when high-output enabled)	3 points	Single-phase AC 100V~230V	-	→P. 77
Solenoid valve multi-axis type (Network specification)		MSEP-④-①-①-①-①-0-0				256 points	
Program control multi-axis type		MSEL-PC-1-35PWAI-①-2-4	4	30,000 points	Single-phase AC 100V~230V	-	→P. 87
Program control multi-axis type (w/network board)		MSEL-PC-1-35PWAI-③-0-4					
Program control multi-axis type (Safety category compliant spec.)		MSEL-PG-1-35PWAI-①-2-4					
Program control multi-axis type (Safety category compliant spec. w/network board)		MSEL-PG-1-35PWAI-③-0-4					

*Above MSEL models are for single-axis specification *① I/O type (NP/PN) *③ Number of axes
 *③ Field network specification code *④ C or LC *⑤ N (NPN specification) or P (PNP specification) code
 *The high output enabled operation is only available when the "High-output setting specs" is selected in the MSEP-C/LC.

RCP5-RA6C ROBO Cylinder, Rod Type, Motor Unit Coupled, Actuator Width 58mm, 24V Pulse Motor

Model	RCP5	RA6C	WA	42P			P3		
Specification Items	Series	Type	Encoder type	Motor type	Lead	Stroke	Applicable controllers	Cable length	Options
			WA: Battery-less absolute specification	42P: Pulse motor, size 42□	20: 20mm 12: 12mm 6: 6mm 3: 3mm	65: 65mm 415: 415mm (Every 50mm)	P3: PCON-CA MSEP MSEL	N: No cable P: 1m S: 3m M: 5m X□: Specified length R□: Robot cable	Please refer to the options table below.

*Controller is not included.

Radial Load Applicable

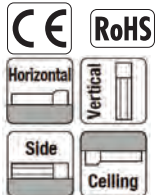

* Depending on the model, there may be some limitations to using the vertical mount position. Please refer to P.59 for details.



- POINT**
Note on selection
- (1) The actuator specification displays the payload's maximum value, but it will vary depending on the acceleration. Please refer to the "Selection Guidelines" (RCP5 Payload by Speed/Acceleration Table) on P. 61.
 - (2) Please refer to P. 59 for push-motion operation.
 - (3) The radial cylinder is equipped with a built-in guide. Please refer to the graphs shown in P. 65 and after for the allowable load mass.

Correlation Diagrams of Speed and Payload

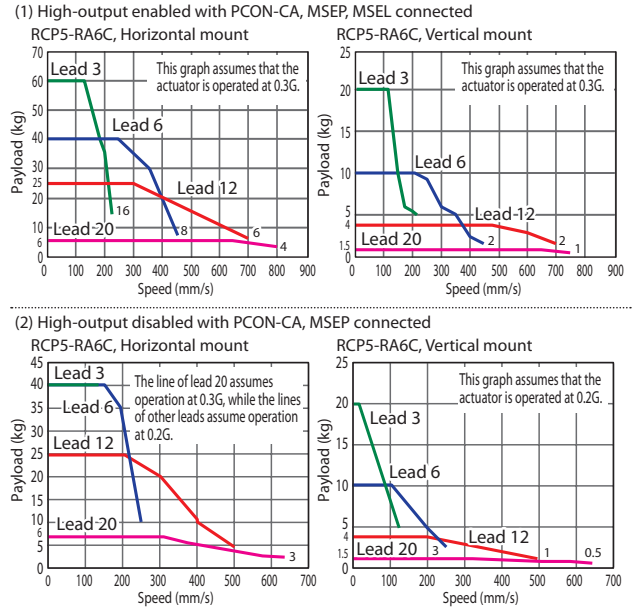

Actuator Specifications

Lead and Payload

Model number	Lead (mm)	Connected controller	Maximum payload		Maximum push force (N)	Stroke (mm)
			Horizontal (kg)	Vertical (kg)		
RCP5-RA6C-WA-42P-20-①-P3-②-③	20	High-output enabled	6	1.5	56	65~415 (Every 50mm)
		High-output disabled				
RCP5-RA6C-WA-42P-12-①-P3-②-③	12	High-output enabled	25	4	93	
		High-output disabled				
RCP5-RA6C-WA-42P-6-①-P3-②-③	6	High-output enabled	40	10	185	
		High-output disabled				
RCP5-RA6C-WA-42P-3-①-P3-②-③	3	High-output enabled	60	20	370	
		High-output disabled	40			

Legend: ① Stroke ② Cable length ③ Options *Please refer to P.59 for push-motion operation.

Stroke and Maximum Speed

Lead (mm)	Connected controller	Maximum speed (Unit: mm/s)	
		65~365 (Every 50mm)	415 (mm)
20	High-output enabled	800	
	High-output disabled	640	
12	High-output enabled	700	
	High-output disabled	500	
6	High-output enabled	450	
	High-output disabled	250	
3	High-output enabled	225	220
	High-output disabled	125	

① Stroke

Stroke (mm)	Standard price	Stroke (mm)	Standard price
65	-	265	-
115	-	315	-
165	-	365	-
215	-	415	-

② Cable Length

Type	Cable code	Standard price
Standard type	P (1m)	-
	S (3m)	-
	M (5m)	-
Special length	X06 (6m) ~X10 (10m)	-
	X11 (11m)~X15 (15m)	-
	X16 (16m)~X20 (20m)	-
	R01 (1m) ~R03 (3m)	-
Robot cable	R04 (4m) ~R05 (5m)	-
	R06 (6m) ~R10 (10m)	-
	R11 (11m)~R15 (15m)	-
	R16 (16m)~R20 (20m)	-

*Please refer to P.89 for maintenance cables.

③ Options

Name	Option code	Reference page	Standard price
Brake	B	→P. 11	-
Cable exit direction (Top)	CJT	→P. 11	-
Cable exit direction (Right)	CJR	→P. 11	-
Cable exit direction (Left)	CJL	→P. 11	-
Cable exit direction (Bottom)	CJB	→P. 11	-
Flange	FL	→P. 12	-
Tip adapter (Flange)	FFA	→P. 12	-
Tip adapter (Internal thread)	NFA	→P. 13	-
Tip adapter (Keyway)	KFA	→P. 13	-
Non-motor end specification	NM	→P. 11	-

Actuator Specifications

Item	Description
Drive system	Ball screw Ø10mm, rolled C10
Positioning repeatability (*1)	±0.02mm [±0.03mm]
Lost motion	0.1mm or less
Rod	Ø25mm Aluminum
Rod non-rotation precision (*2)	0 deg.
Allowable load and torque on rod tip	Refer to table in the page on the right, refer to P.65
Rod tip overhang distance	100mm or less
Ambient operating temperature, humidity	0 to 40°C, 85% RH or less (Non-condensing)

(*1) The values in brackets [] are for Lead 20.

(*2) Rod's angular displacement in rotational direction with no applied load is shown.

Dimensions

CAD drawings can be downloaded from our website. www.intelligentactuator.com



- *1 When the rod is returning to its home position, please be careful of interference from surrounding objects, as it will travel until it reaches the ME.
 - *2 The direction of width across flats varies depending on the product.
 - *3 If the actuator is installed using the front housing and flange, make sure the actuator will not receive any external force.
- ME: Mechanical end
SE: Stroke end

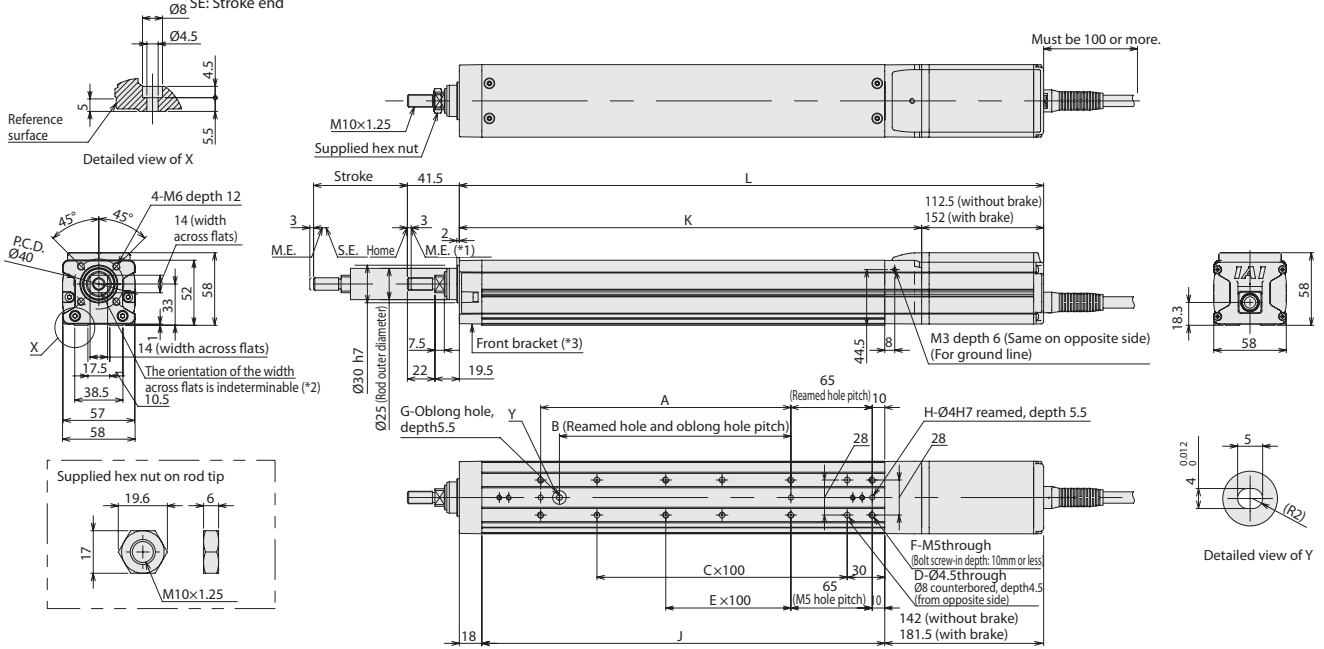

■ Cable Exit Direction (Option)

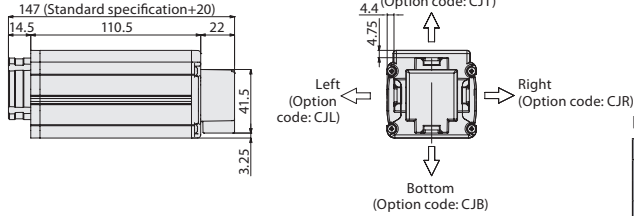

■ Rod Deflection of RCP5-RA6C (Reference Values)

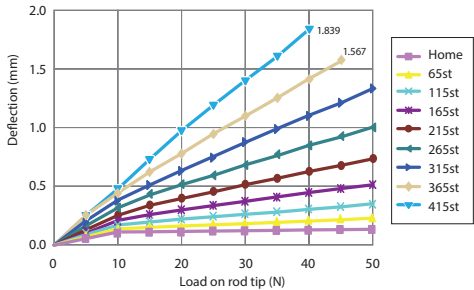

■ Dimensions and Mass by Stroke

Stroke	Stroke								
	65	115	165	215	265	315	365	415	
L	Without brake	332	382	432	482	532	582	632	682
	With brake	371.5	421.5	471.5	521.5	571.5	621.5	671.5	721.5
A	0	100	100	200	200	300	300	400	400
B	0	85	85	185	185	285	285	385	385
C	1	1	2	2	3	3	4	4	4
D	4	4	6	6	8	8	10	10	10
E	0	0	0	1	1	2	2	3	3
F	4	6	6	8	8	10	10	12	12
G	0	1	1	1	1	1	1	1	1
H	2	3	3	3	3	3	3	3	3
J	172	222	272	322	372	422	472	522	522
K	219.5	269.5	319.5	369.5	419.5	469.5	519.5	569.5	569.5
Allowable static load on rod tip (N)	Without brake	113.8	92.6	78.0	67.3	59.0	52.5	47.2	42.8
	With brake	45.7	36.3	29.8	25.1	21.6	18.8	16.6	14.7
Allowable dynamic load on rod tip (N)	Without brake	32.1	28.3	24.6	21.5	18.9	16.7	14.9	13.4
	With brake	11.5	9.4	7.9	6.8	6.0	5.4	4.9	4.5
Allowable static torque on rod tip (N·m)	Without brake	3.2	2.8	2.5	2.1	1.9	1.7	1.5	1.3
	With brake	1.8	2.0	2.2	2.4	2.6	2.9	3.1	3.3
Mass (kg)	Without brake	2.0	2.2	2.4	2.6	2.8	3.1	3.3	3.5
	With brake	2.0	2.2	2.4	2.6	2.8	3.1	3.3	3.5

Applicable Controllers

The RCP5 series actuators can be operated by the controllers indicated below. Please select the type depending on your intended use.

Name	External view	Model number	Max. number of controlled axes	Maximum number of positioning points	Input power	Standard price	Reference page
Positioner type (High-output specification)		PCON-CA-42PWAI-①-2-0	1	512 points	DC24V	-	→P.69
Pulse train type (High-output specification)		PCON-CA-42PWAI-PL⑤-2-0					
Network type (High-output specification)		PCON-CA-42PWAI-③④-0-0					
Solenoid valve multi-axis type (PIO specification)		MSEL-④①①①①-①-2-0	4 (4 when high-output enabled) LC: 6 (3 when high-output enabled)	3 points	Single-phase AC 100V~230V	-	→P.77
Solenoid valve multi-axis type (Network specification)		MSEL-④①①①①-①-0-0					
Program control multi-axis type		MSEL-PC-1-42PWAI-①-2-4	4	30,000 points	Single-phase AC 100V~230V	-	→P.87
Program control multi-axis type (w/network board)		MSEL-PC-1-42PWAI-③④-0-4					
Program control multi-axis type (Safety category compliant spec.)		MSEL-PG-1-42PWAI-①-2-4					
Program control multi-axis type (Safety category compliant spec. w/network board)		MSEL-PG-1-42PWAI-③④-0-4					

*Above MSEL models are for single-axis specification
 *① I/O type (NP/PN)
 *③④ Field network specification code
 *④ C or LC
 *①①①① Number of axes
 *①①①① N (NPN specification) or P (PNP specification) code
 *The high output enabled operation is only available when the "High-output setting specs" is selected in the MSEL-C/LC.

RCP5-RA7C ROBO Cylinder, Rod Type, Motor Unit Coupled, Actuator Width 73mm, 24V Pulse Motor

Model	RCP5	RA7C	WA	56P			P3		
Specification Items	Series	Type	Encoder type	Motor type	Lead	Stroke	Applicable controllers	Cable length	Options
			WA: Battery-less absolute specification	56P: Pulse motor, size 56□	24: 24mm 16: 16mm 8: 8mm 4: 4mm	70: 70mm 520: 520mm (Every 50mm)	P3: PCON-CA MSEP MSEL	N: No cable P: 1m S: 3m M: 5m X□: Specified length R□: Robot cable	Please refer to the options table below.

*Controller is not included.

Radial Load Applicable

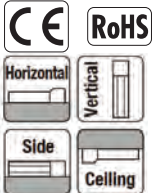

* Depending on the model, there may be some limitations to using the vertical mount position. Please refer to P.59 for details.



- POINT**
Note on selection
- The actuator specification displays the payload's maximum value, but it will vary depending on the acceleration. Please refer to the "Selection Guidelines" (RCP5 Payload by Speed/Acceleration Table) on P. 61.
 - Please refer to P. 59 for push-motion operation.
 - The radial cylinder is equipped with a built-in guide. Please refer to the graphs shown in P. 65 and after for the allowable load mass.

Correlation Diagrams of Speed and Payload

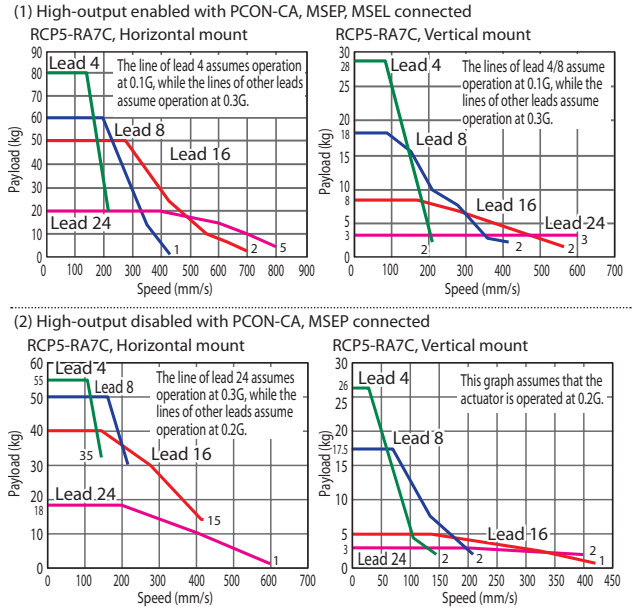

Actuator Specifications

Lead and Payload

Model number	Lead (mm)	Connected controller	Maximum payload		Maximum push force (N)	Stroke (mm)
			Horizontal (kg)	Vertical (kg)		
RCP5-RA7C-WA-56P-24-①-P3-②-③	24	High-output enabled	20	3	182	70~520 (Every 50mm)
		High-output disabled	18	3		
RCP5-RA7C-WA-56P-16-①-P3-②-③	16	High-output enabled	50	8	273	
		High-output disabled	40	5		
RCP5-RA7C-WA-56P-8-①-P3-②-③	8	High-output enabled	60	18	547	
		High-output disabled	50	17.5		
RCP5-RA7C-WA-56P-4-①-P3-②-③	4	High-output enabled	80	28	1,094	
		High-output disabled	55	26		

Legend: ① Stroke ② Cable length ③ Options *Please refer to P.59 for push-motion operation.

Stroke and Maximum Speed

Values in brackets <> are for vertical use. (Unit: mm/s)

Lead (mm)	Connected controller	70~520 (Every 50mm)
24	High-output enabled	800 <600>
	High-output disabled	600 <400>
16	High-output enabled	700 <560>
	High-output disabled	420
8	High-output enabled	420
	High-output disabled	210
4	High-output enabled	210
	High-output disabled	140

① Stroke

Stroke (mm)	Standard price	Stroke (mm)	Standard price
70	-	320	-
120	-	370	-
170	-	420	-
220	-	470	-
270	-	520	-

② Cable Length

Type	Cable code	Standard price
Standard type	P (1m)	-
	S (3m)	-
	M (5m)	-
Special length	X06 (6m) ~X10 (10m)	-
	X11 (11m)~X15 (15m)	-
	X16 (16m)~X20 (20m)	-
	R01 (1m) ~R03 (3m)	-
Robot cable	R04 (4m) ~R05 (5m)	-
	R06 (6m) ~R10 (10m)	-
	R11 (11m)~R15 (15m)	-
	R16 (16m)~R20 (20m)	-

*Please refer to P. 89 for maintenance cables.

③ Options

Name	Option code	Reference page	Standard price
Brake	B	→P. 11	-
Cable exit direction (Top)	CJT	→P. 11	-
Cable exit direction (Right)	CJR	→P. 11	-
Cable exit direction (Left)	CJL	→P. 11	-
Cable exit direction (Bottom)	CJB	→P. 11	-
Flange	FL	→P. 12	-
Tip adapter (Flange)	FFA	→P. 12	-
Tip adapter (Internal thread)	NFA	→P. 13	-
Tip adapter (Keyway)	KFA	→P. 13	-
Non-motor end specification	NM	→P. 11	-

Actuator Specifications

Item	Description
Drive system	Ball screw Ø12mm, rolled C10
Positioning repeatability (*1)	±0.02mm [±0.03mm]
Lost motion	0.1mm or less
Rod	Ø30mm Aluminum
Rod non-rotation precision (*2)	0 deg.
Allowable load and torque on rod tip	Refer to table in the page on the right, refer to P.65
Rod tip overhang distance	100mm or less
Ambient operating temperature, humidity	0 to 40°C, 85% RH or less (Non-condensing)

(*1) The values in brackets [] are for Lead 24.

(*2) Rod's angular displacement in rotational direction with no applied load is shown.

Dimensions

CAD drawings can be downloaded from our website. www.intelligentactuator.com



- *1 When the rod is returning to its home position, please be careful of interference from surrounding objects, as it will travel until it reaches the ME.
- *2 The direction of width across flats varies depending on the product.
- *3 If the actuator is installed using the front housing and flange, make sure the actuator will not receive any external force.

ME: Mechanical end
SE: Stroke end

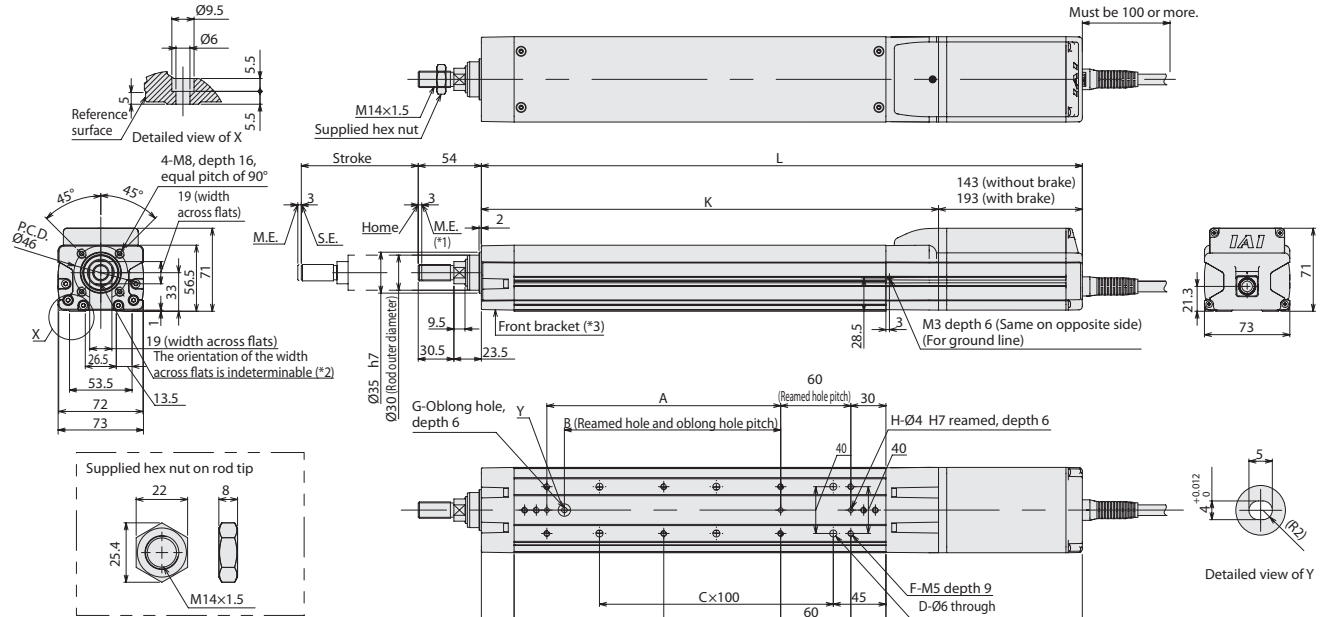

■ Cable Exit Direction (Option)

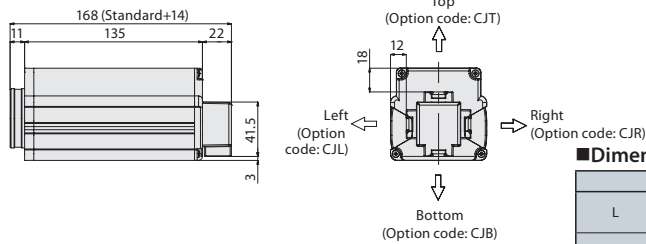

■ Dimensions and Mass by Stroke

Stroke	70	120	170	220	270	320	370	420	470	520	
L	Without brake	384	434	484	534	584	634	684	734	784	834
	With brake	434	484	534	584	634	684	734	784	834	884
A	0	100	100	200	200	300	300	400	400	500	500
B	0	85	85	185	185	285	285	385	385	485	485
C	1	1	2	2	3	3	4	4	5	5	5
D	4	4	6	6	8	8	10	10	12	12	12
E	0	0	0	1	1	2	2	3	3	4	4
F	4	6	6	8	8	10	10	12	12	14	14
G	0	1	1	1	1	1	1	1	1	1	1
H	2	3	3	3	3	3	3	3	3	3	3
J	168	218	268	318	368	418	468	518	568	618	618
K	241	291	341	391	441	491	541	591	641	691	691
Allowable static load on rod tip (N)	Without brake	119.2	97.7	82.8	71.6	63.0	56.2	50.6	46.0	42.2	38.8
	With brake	44.3	35.7	29.6	25.2	21.7	19.0	16.8	15.0	13.6	12.2
Allowable dynamic load on rod tip (N)	Without brake	33.9	29.7	25.7	22.4	19.7	17.4	15.5	14.0	12.8	11.5
	With brake	3.4	3.0	2.6	2.2	2.0	1.7	1.6	1.4	1.3	1.2
Allowable static torque on rod tip (N·m)	Without brake	3.3	3.6	3.9	4.2	4.5	4.8	5.1	5.4	5.6	5.9
	With brake	3.8	4.1	4.4	4.7	5.0	5.3	5.6	5.9	6.1	6.4

■ Rod Deflection of RCP5-RA7C (Reference Values)

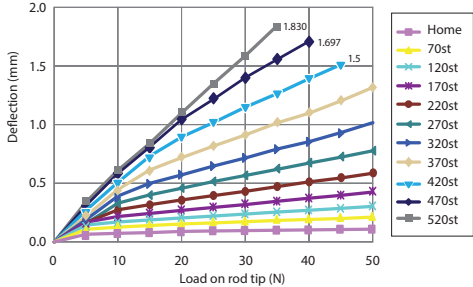

Applicable Controllers

The RCP5 series actuators can be operated by the controllers indicated below. Please select the type depending on your intended use.

Name	External view	Model number	Max. number of controlled axes	Maximum number of positioning points	Input power	Standard price	Reference page
Positioner type (High-output specification)		PCON-CA-56PWAI-①-2-0	1	512 points	DC24V	-	→P.69
Pulse train type (High-output specification)		PCON-CA-56PWAI-PL②-2-0		-			
Network type (High-output specification)		PCON-CA-56PWAI-③-0-0		768 points		-	
Solenoid valve multi-axis type (PIO specification)		MSEP-④-⑤-⑥-⑦-⑧-2-0	C: 8 (4 when high-output enabled) LC: 6 (3 when high-output enabled)	3 points	Single-phase AC 100V~230V	-	→P.77
Solenoid valve multi-axis type (Network specification)		MSEP-④-⑤-⑥-⑦-⑧-0-0		256 points		-	
Program control multi-axis type		MSEL-PC-1-56PWAI-⑨-2-4	4	30,000 points	Single-phase AC 100V~230V	-	→P.87
Program control multi-axis type (w/network board)		MSEL-PC-1-56PWAI-⑩-0-4					
Program control multi-axis type (Safety category compliant spec.)		MSEL-PG-1-56PWAI-⑪-2-4					
Program control multi-axis type (Safety category compliant spec. w/network board)		MSEL-PG-1-56PWAI-⑫-0-4					

*Above MSEL models are for single-axis specification
 *① I/O type (NP/PN)
 *② Field network specification code
 *③ C or LC
 *④ Number of axes
 *⑤ N (NPN specification) or P (PNP specification) code
 *The high output enabled operation is only available when the "High-output setting specs" is selected in the MSEP-C/LC.

RCP5-RA8C ROBO Cylinder, High-thrust Rod Type, Motor Unit Coupled, Actuator Width 88mm, 24V Pulse Motor

Model	RCP5	RA8C	WA	60P			P4		
Specification Items	Series	Type	Encoder type	Motor type	Lead	Stroke	Applicable controller	Cable length	Options
			WA: Battery-less absolute specification	60P: Pulse motor, size 60□	20: 20mm 10: 10mm 5: 5mm	50: 50mm 700: 700mm (Every 50mm)	P4: PCON-CFA	N: No cable P: 1m S: 3m M: 5m X□: Specified length R□: Robot cable	Please refer to the options table below.

*Controller is not included.

Radial Load Applicable

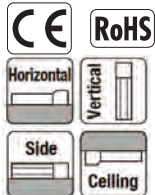

* Depending on the model, there may be some limitations to using the vertical mount position. Please refer to P.59 for details.



- POINT**
Note on selection
- (1) The payload assumes operation at an acceleration of 0.1G for lead 5 and operation at an acceleration of 0.2G for lead 10 and lead 20. The above values are the upper limits of acceleration/deceleration.
 - (2) Please note that the RA8C requires a dedicated controller (high-thrust PCON-CFA).
 - (3) The radial cylinder is equipped with a built-in guide. Please refer to the graphs shown in P. 65 and after for the allowable load mass.

Correlation Diagrams of Speed and Payload

RCP5-RA8C, Horizontal mount, PCON-CFA connected

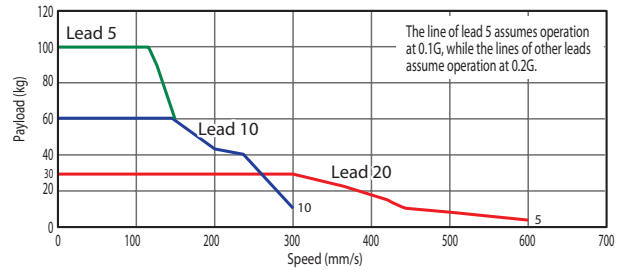

RCP5-RA8C, Vertical mount, PCON-CFA connected

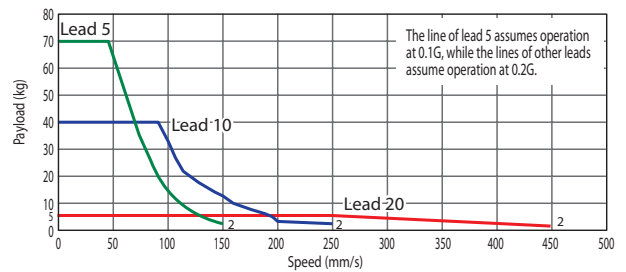

Actuator Specifications

Lead and Payload

Model number	Lead (mm)	Connected controller	Maximum payload		Maximum push force (N)	Stroke (mm)
			Horizontal (kg)	Vertical (kg)		
RCP5-RA8C-WA-60P-20-①-P4-②-③	20	PCON-CFA	30	5	500	50~700 (Every 50mm)
RCP5-RA8C-WA-60P-10-①-P4-②-③	10	PCON-CFA	60	40	1,000	
RCP5-RA8C-WA-60P-5-①-P4-②-③	5	PCON-CFA	100	70	2,000	

Legend: ① Stroke ② Cable length ③ Options *Please refer to P. 59 for push-motion operation.

Stroke and Maximum Speed

Values in brackets <> are for vertical use. (Unit: mm/s)

Lead (mm)	50 (mm)	100 (mm)	150 (mm)	200 (mm)	250~350 (mm)	400 (mm)	450 (mm)	500 (mm)	550 (mm)	600 (mm)	650 (mm)	700 (mm)
20	280	405	505 <450>	585 <450>	600 <450>	520 <450>	440	360	320	280	240	220
10	280 <250>	300 <250>			260 <250>	220	180	160	140	120	110	
5	150					130	110	90	80	70	60	55

① Stroke

Stroke (mm)	Standard price	Stroke (mm)	Standard price
50	-	400	-
100	-	450	-
150	-	500	-
200	-	550	-
250	-	600	-
300	-	650	-
350	-	700	-

② Cable Length

Type	Cable code	Standard price
Standard type	P (1m)	-
	S (3m)	-
	M (5m)	-
Special length	X06 (6m) ~ X10 (10m)	-
	X11 (11m)~ X15 (15m)	-
	X16 (16m)~ X20 (20m)	-
	R01 (1m) ~ R03 (3m)	-
Robot cable	R04 (4m) ~ R05 (5m)	-
	R06 (6m) ~ R10 (10m)	-
	R11 (11m)~ R15 (15m)	-
	R16 (16m)~ R20 (20m)	-

*Please refer to P. 89 for maintenance cables.

③ Options

Name	Option code	Reference page	Standard price
Brake	B	→P. 11	-
Cable exit direction (Top)	CJT	→P. 11	-
Cable exit direction (Right)	CJR	→P. 11	-
Cable exit direction (Left)	CJL	→P. 11	-
Cable exit direction (Bottom)	CJB	→P. 11	-
Flange	FL	→P. 12	-
Non-motor end specification	NM	→P. 11	-

Actuator Specifications

Item	Description
Drive system	Ball screw Ø16mm, rolled C10
Positioning repeatability	±0.02mm
Lost motion	0.1mm or less
Rod	Ø40mm Aluminum
Rod non-rotation precision (*1)	0 deg.
Allowable load and torque on rod tip	Refer to table in the page on the right, refer to P. 65
Rod tip overhang distance	100mm or less
Ambient operating temperature, humidity	0 to 40°C, 85% RH or less (Non-condensing)

(*1) Rod's angular displacement in rotational direction with no applied load is shown.

Dimensions

CAD drawings can be downloaded from our website. www.intelligentactuator.com



- *1 When the rod is returning to its home position, please be careful of interference from surrounding objects, as it will travel until it reaches the ME.
- *2 The direction of width across flats varies depending on the product.
- *3 If the actuator is installed using the front housing and flange, make sure the actuator will not receive any external force.
ME: Mechanical end
SE: Stroke end

■ Dimensions with Flange (Option)

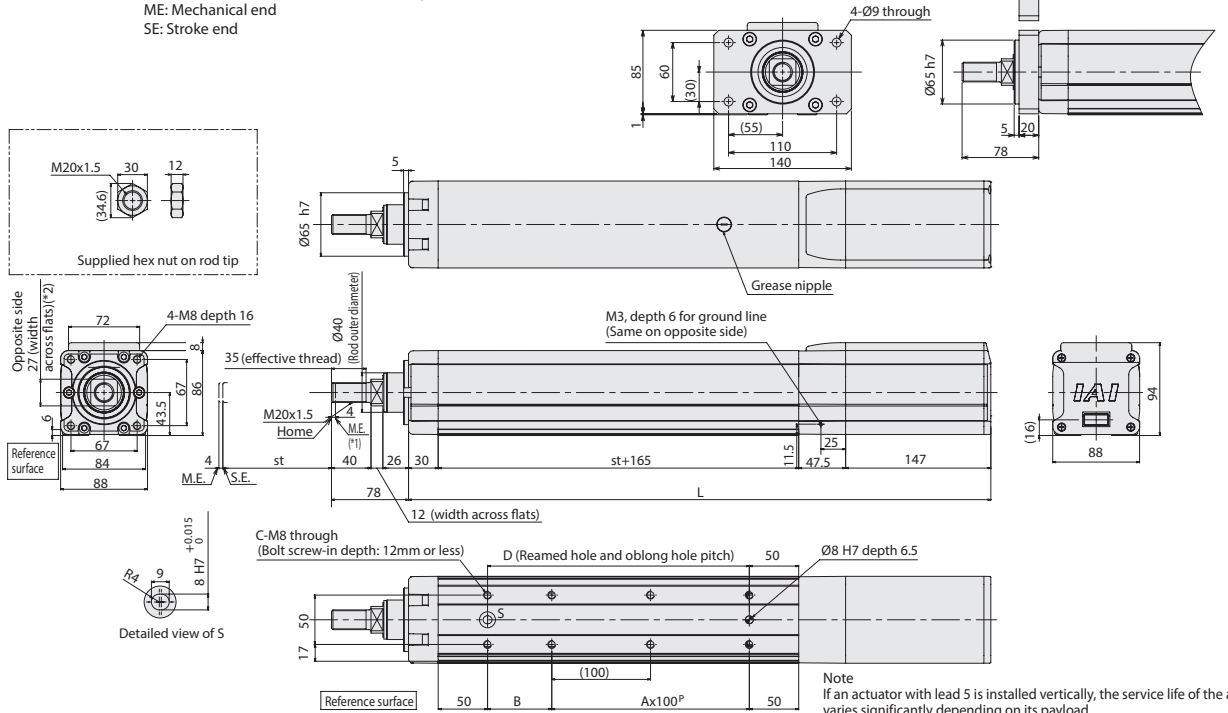

■ Dimensions with Brake (Option)

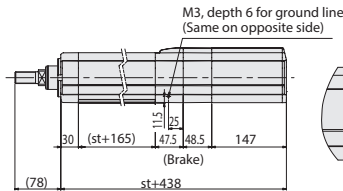

■ 4 Cable Exit Directions (Option)

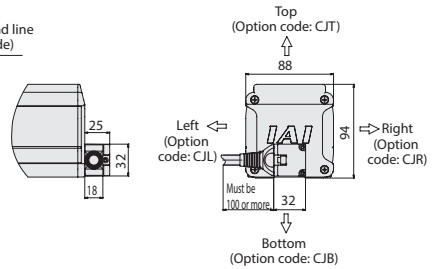

Note
If an actuator with lead 5 is installed vertically, the service life of the actuator varies significantly depending on its payload.
Please refer to the correlation diagram of vertical load and traveling life shown below.
(If the actuator is installed horizontally, its service life is not affected by the payload.)

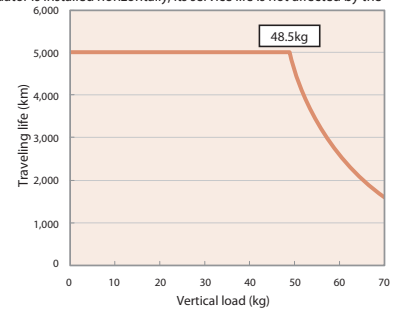

■ Rod Deflection of RCP5-RA8C

(The graph below shows the measurements of how much a horizontally installed rod would deflect when a load is applied to the end of the rod. The measured deflection includes the deflection due to the weight of the rod.)

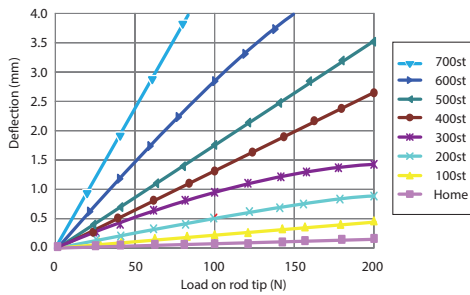

■ Dimensions and Mass by Stroke

Stroke	L	50	100	150	200	250	300	350	400	450	500	550	600	650	700
		Without brake	439.5	489.5	539.5	589.5	639.5	689.5	739.5	789.5	839.5	889.5	939.5	989.5	1,039.5
With brake		488	538	588	638	688	738	788	838	888	938	988	1,038	1,088	1,138
A		0	1	1	2	2	3	3	4	4	5	5	6	6	7
B		115	65	115	65	115	65	115	65	115	65	115	65	115	65
C		4	6	6	8	8	10	10	12	12	14	14	16	16	18
D		115	165	215	265	315	365	415	465	515	565	615	665	715	765
Allowable static load on rod tip (N)		180	150.3	128.9	112.7	99.9	89.7	81.3	74.3	68.3	63.1	58.6	54.6	51.1	47.9
Allowable dynamic load on rod tip (N)		73.6	60.3	51.0	44.1	38.7	34.3	30.7	27.7	25.2	23.0	21.1	19.4	17.8	16.5
Allowable static torque on rod tip (N·m)		18.1	15.2	13.0	11.4	10.2	9.2	8.4	7.7	7.1	6.6	6.1	5.8	5.4	5.1
Allowable dynamic torque on rod tip (N·m)		5.7	4.9	4.3	3.8	3.4	3.0	2.8	2.5	2.3	2.1	2.0	1.8	1.7	1.5
Mass (kg)		7.1	7.6	8.0	8.4	8.9	9.3	9.7	10.2	10.6	11.0	11.4	11.9	12.3	12.7
		8.3	8.7	9.1	9.6	10.0	10.4	10.9	11.3	11.7	12.1	12.6	13.0	13.4	13.9

Applicable Controllers

The RCP5 series actuators can be operated by the controllers indicated below. Please select the type depending on your intended use.

Name	External view	Model number	Maximum number of positioning points	Input power	Standard price	Reference page
Positioner type		PCON-CFA-60PWAI-NP-2-0 PCON-CFA-60PWAI-PN-2-0	512 points	DC24V	-	→P. 69
Pulse-train type		PCON-CFA-60PWAI-PLN-2-0 PCON-CFA-60PWAI-PLP-2-0	—			
Field network type		PCON-CFA-60PWAI-①-0-0	768 points			

*① Field network specification code (DV, CC, PR, CN, ML, EC, EP)

RCP5-RA10C ROBO Cylinder, High-thrust Rod Type, Motor Unit Coupled, Actuator Width 108mm, 24V Pulse Motor

Model	RCP5-RA10C	WA	86P			P4			
Specification Items	Series	Type	Encoder type	Motor type	Lead	Stroke	Applicable controller	Cable length	Options
		WA: Battery-less absolute specification		86P: Pulse motor, size 86□	10: 10mm 5: 5mm 2.5: 2.5mm	50: 50mm 800: 800mm (Every 50mm)	P4: PCON-CFA	N: No cable P: 1m S: 3m M: 5m X□: Specified length R□: Robot cable	Please refer to the options table below.

*Controller is not included.

Radial Load Applicable

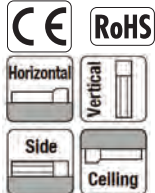

* Depending on the model, there may be some limitations to using the vertical mount position. Please refer to P.59 for details.



- POINT**
Note on selection
- (1) The payload assumes operation at an acceleration of 0.01G for lead 2.5, operation at an acceleration of 0.02G for lead 5 and operation at an acceleration of 0.04G for lead 10. The above values are the upper limits of acceleration/deceleration.
 - (2) Please note that the RA10C requires a dedicated controller (high-thrust PCON-CFA).
 - (3) The radial cylinder is equipped with a built-in guide. Please refer to the graphs shown in P. 65 and after for the allowable load mass.

Correlation Diagrams of Speed and Payload

RCP5-RA10C, Horizontal mount, PCON-CFA connected

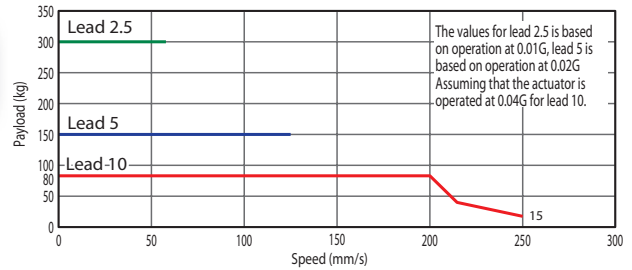

RCP5-RA10C, Vertical mount, PCON-CFA connected

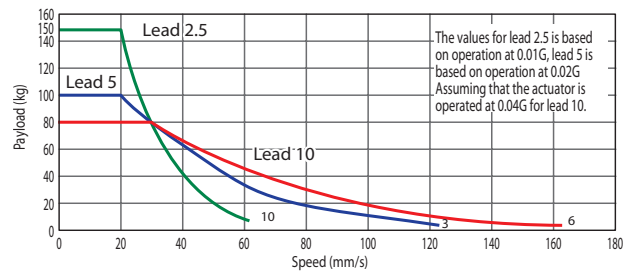

Actuator Specifications

Lead and Payload

Model number	Lead (mm)	Connected controller	Maximum payload		Maximum push force (N)	Stroke (mm)
			Horizontal (kg)	Vertical (kg)		
RCP5-RA10C-WA-86P-10-①-P4-②-③	10	PCON-CFA	80	80	1,500	50~800 (Every 50mm)
RCP5-RA10C-WA-86P-5-①-P4-②-③	5	PCON-CFA	150	100	3,000	
RCP5-RA10C-WA-86P-2.5-①-P4-②-③	2.5	PCON-CFA	300	150	6,000	

Legend: ① Stroke ② Cable length ③ Options *Please refer to P. 59 for push-motion operation.

Stroke and Maximum Speed

Values in brackets <> are for vertical use. (Unit: mm/s)

Lead (mm)	50 (mm)	100 (mm)	150 (mm)	200~400 (Every 50mm)	450 (mm)	500 (mm)	550 (mm)	600 (mm)	650 (mm)	700 (mm)	750 (mm)	800 (mm)
10	117	167	200	<167>	250	<167>	220	200	180	160	140	120
5	83		125		110	90	80	70	60	55	50	45
2.5			63				55	50	45	40	35	30

① Stroke

Stroke (mm)	Standard price	Stroke (mm)	Standard price
50	-	450	-
100	-	500	-
150	-	550	-
200	-	600	-
250	-	650	-
300	-	700	-
350	-	750	-
400	-	800	-

② Cable Length

Type	Cable code	Standard price
Standard type	P (1m)	-
	S (3m)	-
	M (5m)	-
Special length	X06 (6m) ~X10 (10m)	-
	X11 (11m)~X15 (15m)	-
	X16 (16m)~X20 (20m)	-
	R01 (1m) ~R03 (3m)	-
Robot cable	R04 (4m) ~R05 (5m)	-
	R06 (6m) ~R10 (10m)	-
	R11 (11m)~R15 (15m)	-
	R16 (16m)~R20 (20m)	-

*Please refer to P. 89 for maintenance cables.

③ Options

Name	Option code	Reference page	Standard price
Brake	B	→P. 11	-
Cable exit direction (Top)	CJT	→P. 11	-
Cable exit direction (Right)	CJR	→P. 11	-
Cable exit direction (Left)	CJL	→P. 11	-
Cable exit direction (Bottom)	CJB	→P. 11	-
Flange	FL	→P. 12	-
Non-motor end specification	NM	→P. 11	-

Actuator Specifications

Item	Description
Drive system	Ball screw Ø20mm (Lead 2.5/10mm), Ø16mm (Lead 5mm), rolled C10
Positioning repeatability	±0.02mm
Lost motion	0.1mm or less
Rod	Ø40mm Aluminum
Rod non-rotation precision (*1)	0 deg.
Allowable load and torque on rod tip	Refer to table in the page on the right, refer to P. 65
Rod tip overhang distance	100mm or less
Ambient operating temperature, humidity	0 to 40°C, 85% RH or less (Non-condensing)

(*1) Rod's angular displacement in rotational direction with no applied load is shown.

Dimensions

CAD drawings can be downloaded from our website. www.intelligentactuator.com



- *1 When the rod is returning to its home position, please be careful of interference from surrounding objects, as it will travel until it reaches the ME.
- *2 The direction of width across flats varies depending on the product.
- *3 If the actuator is installed using the front housing and flange, make sure the actuator will not receive any external force.
ME: Mechanical end
SE: Stroke end

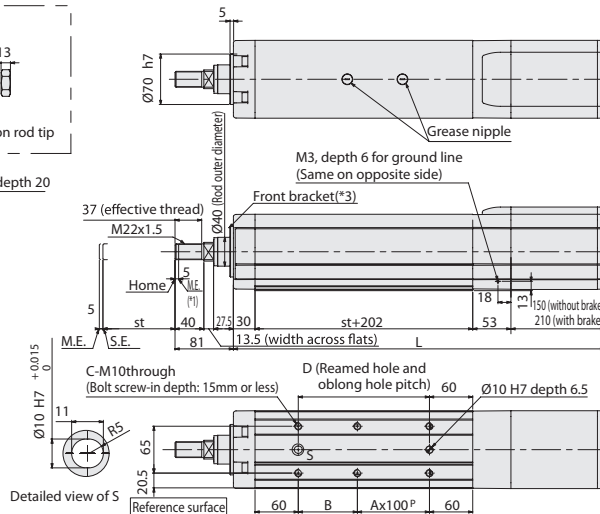
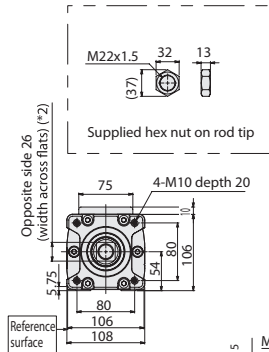

Dimensions with Flange (Option)

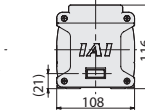
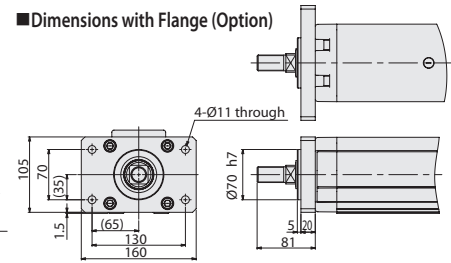

4 Cable Exit Directions (Option)

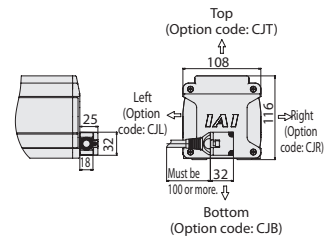

Rod Deflection of RCP5-RA10C

(The graph below shows the measurements of how much a horizontally installed rod would deflect when a load is applied to the end of the rod. The measured deflection includes the deflection due to the weight of the rod.)

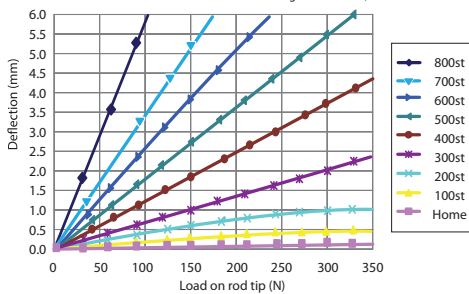

Dimensions and Mass by Stroke

Stroke	L	Stroke															
		50	100	150	200	250	300	350	400	450	500	550	600	650	700	750	800
Without brake	485	535	585	635	685	735	785	835	885	935	985	1,035	1,085	1,135	1,185	1,235	
	545	595	645	695	745	795	845	895	945	995	1,045	1,095	1,145	1,195	1,245	1,295	
With brake	0	1	2	2	3	3	4	4	5	5	6	6	7	7	8		
	132	82	132	82	132	82	132	82	132	82	132	82	132	82	132	82	
C	4	6	6	8	8	10	10	12	12	14	14	16	16	18	18	20	
	132	182	232	282	332	382	432	482	532	582	632	682	732	782	832	882	
Allowable static load on rod tip (N)	316.9	268.4	232.6	205.1	183.4	165.7	151.0	138.6	128.1	119.0	111.0	103.9	97.7	92.1	87.0	82.5	
	119.1	99.1	84.7	73.8	65.3	58.5	52.8	48.1	44.0	40.5	37.5	34.8	32.4	30.2	28.3	26.5	
Allowable dynamic load on rod tip (N)	100.7	85.9	74.9	66.3	59.3	53.6	48.8	44.7	41.2	38.1	35.4	32.9	30.8	28.8	27.0	25.4	
	31.8	27.0	23.4	20.7	18.5	16.8	15.3	14.1	13.1	12.2	11.4	10.7	10.1	9.6	9.1	8.6	
Allowable static torque on rod tip (N·m)	10.1	8.6	7.5	6.6	5.9	5.4	4.9	4.5	4.1	3.8	3.5	3.3	3.1	2.9	2.7	2.5	
	11.5	12.2	12.9	13.6	14.3	15	15.7	16.4	17.1	17.8	18.5	19.2	19.9	20.6	21.3	22	
Mass (kg)	13.1	13.8	14.5	15.2	15.9	16.6	17.3	18	18.7	19.4	20.1	20.8	21.5	22.2	22.9	23.6	

Correlation Diagrams of Vertical Load and Traveling Life

Since the RCP5-RA10C has a greater maximum thrust than other types, its service life varies significantly depending on the payload and push force applied when the actuator is installed vertically. When selecting an appropriate type from the correlation diagram of speed and payload or correlation diagram of push force and current-limiting value, check its traveling life on the correlation diagram of payload and service life as well as on the correlation diagram of push force and service life.

Note
The rated value represents the maximum value at a traveling life of 5,000km. The greatest value is the maximum value at which the actuator can operate. Take note that, if an actuator is operated beyond its rating, its service life will drop as shown by the applicable graph on the right.

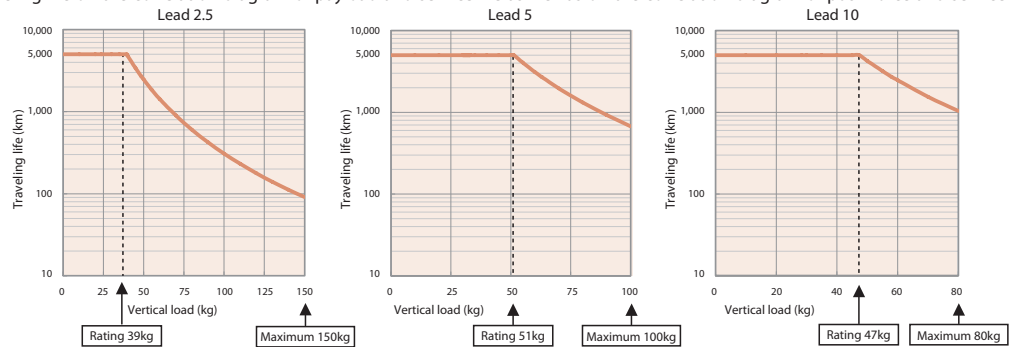

Applicable Controllers

The RCP5 series actuators can be operated by the controllers indicated below. Please select the type depending on your intended use.

Name	External view	Model number	Maximum number of positioning points	Input power	Standard price	Reference page
Positioner type		PCON-CFA-86PWAI-NP-2-0 PCON-CFA-86PWAI-PN-2-0	512 points	DC24V	-	→P. 69
Pulse-train type		PCON-CFA-86PWAI-PLN-2-0 PCON-CFA-86PWAI-PLP-2-0	-			
Field network type		PCON-CFA-86PWAI-①-0-0	768 points			

*① Field network specification code (DV, CC, PR, CN, ML, EC, EP)

RCP5-RA4R ROBO Cylinder, Rod Type, Side-mounted Motor Type, Actuator Width 40mm, 24V Pulse Motor

Model	RCP5	RA4R	WA	35P			P3		
Specification	Series	Type	Encoder type	Motor type	Lead	Stroke	Applicable controllers	Cable length	Options
Items			WA: Battery-less absolute specification	35P: Pulse motor, size 35□	16: 16mm 10: 10mm 5: 5mm 2.5: 2.5mm	60: 60mm 410: 410mm (Every 50mm)	P3: PCON-CA MSEP MSEL	N: No cable P: 1m S: 3m M: 5m X□: Specified length R□: Robot cable	Please refer to the options table below.

*Controller is not included.

Radial Load Applicable



* Depending on the model, there may be some limitations to using the vertical mount position. Please refer to P.59 for details.

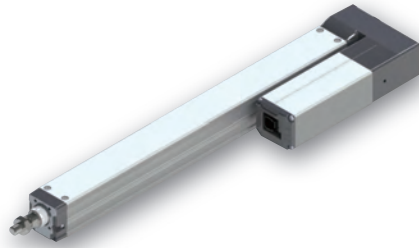

The figure above is the motor side-mounted to the left (ML).

POINT
Note on selection

- The actuator specification displays the payload's maximum value, but it will vary depending on the acceleration. Please refer to the "Selection Guidelines" (RCP5 Payload by Speed/Acceleration Table) on P. 61.
- Please refer to P. 59 for push-motion operation.
- The radial cylinder is equipped with a built-in guide. Please refer to the graphs shown in P. 65 and after for the allowable load mass.

Correlation Diagrams of Speed and Payload

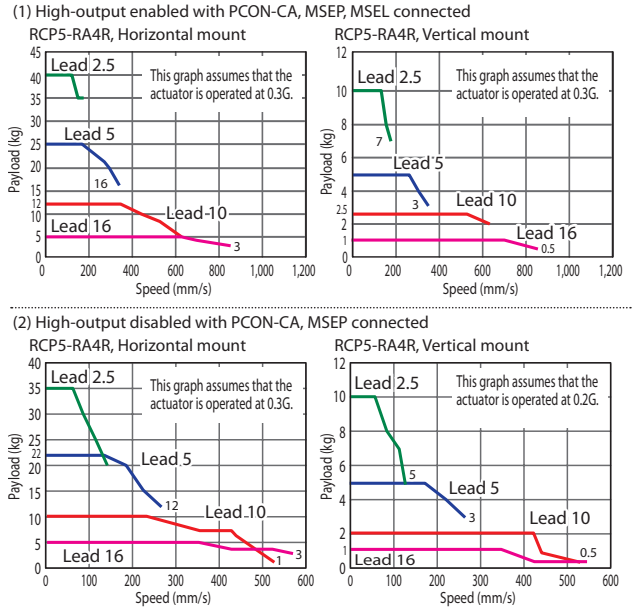

Actuator Specifications

Lead and Payload

Model number	Lead (mm)	Connected controller	Maximum payload		Maximum push force (N)	Stroke (mm)
			Horizontal (kg)	Vertical (kg)		
RCP5-RA4R-WA-35P-16-①-P3-②-③	16	High-output enabled	5	1	48	60~410 (Every 50mm)
		High-output disabled				
RCP5-RA4R-WA-35P-10-①-P3-②-③	10	High-output enabled	12	2.5	77	
		High-output disabled	10	2		
RCP5-RA4R-WA-35P-5-①-P3-②-③	5	High-output enabled	25	5	155	
		High-output disabled	22			
RCP5-RA4R-WA-35P-2.5-①-P3-②-③	2.5	High-output enabled	40	10	310	
		High-output disabled	35			

Legend: ① Stroke ② Cable length ③ Options *Please refer to P. 59 for push-motion operation.

Stroke and Maximum Speed

(Unit: mm/s)

Lead (mm)	Connected controller	60~360 (Every 50mm)		410 (mm)
		60~360 (Every 50mm)	410 (mm)	
16	High-output enabled	840		
	High-output disabled	560		
10	High-output enabled	610		
	High-output disabled	525		
5	High-output enabled	350	340	
	High-output disabled	260		
2.5	High-output enabled	175	170	
	High-output disabled	130		

① Stroke

Stroke (mm)	Standard price	Stroke (mm)	Standard price
60	-	260	-
110	-	310	-
160	-	360	-
210	-	410	-

③ Options

Name	Option code	Reference page	Standard price
Brake	B	→P. 11	-
Cable exit direction (Top)	CJT	→P. 11	-
Cable exit direction (Outside)	CJO	→P. 11	-
Cable exit direction (Bottom)	CJB	→P. 11	-
Flange	FL	→P. 12	-
Tip adapter (Flange)	FFA	→P. 12	-
Tip adapter (Internal thread)	NFA	→P. 13	-
Tip adapter (Keyway)	KFA	→P. 13	-
Motor side-mounted to the left (Standard)	ML	→P. 11	-
Motor side-mounted to the right	MR	→P. 11	-
Non-motor end specification	NM	→P. 11	-

Depending on the stroke, some rod attachment options are not available. Also, when selecting the shorter strokes, please be careful of nearby objects. Some interference may occur. Please refer to P. 14.

② Cable Length

Type	Cable code	Standard price
Standard type	P (1m)	-
	S (3m)	-
	M (5m)	-
Special length	X06 (6m) ~ X10 (10m)	-
	X11 (11m)~ X15 (15m)	-
	X16 (16m)~ X20 (20m)	-
	R01 (1m) ~ R03 (3m)	-
Robot cable	R04 (4m) ~ R05 (5m)	-
	R06 (6m) ~ R10 (10m)	-
	R11 (11m)~ R15 (15m)	-
	R16 (16m)~ R20 (20m)	-

*Please refer to P. 89 for maintenance cables.

Actuator Specifications

Item	Description
Drive system	Ball screw Ø8mm, rolled C10
Positioning repeatability	±0.02mm
Lost motion	0.1mm or less
Rod	Ø20mm Aluminum
Rod non-rotation precision (*1)	0 deg.
Allowable load and torque on rod tip	Refer to table in the page on the right, refer to P. 65
Rod tip overhang distance	100mm or less
Ambient operating temperature, humidity	0 to 40°C, 85% RH or less (Non-condensing)

(*1) Rod's angular displacement in rotational direction with no applied load is shown.

Dimensions

CAD drawings can be downloaded from our website. www.intelligentactuator.com



- *1 When the rod is returning to its home position, please be careful of interference from surrounding objects, as it will travel until it reaches the ME.
- *2 The direction of width across flats varies depending on the product.
- *3 If the actuator is installed using the front housing and flange, make sure the actuator will not receive any external force.
ME: Mechanical end
SE: Stroke end

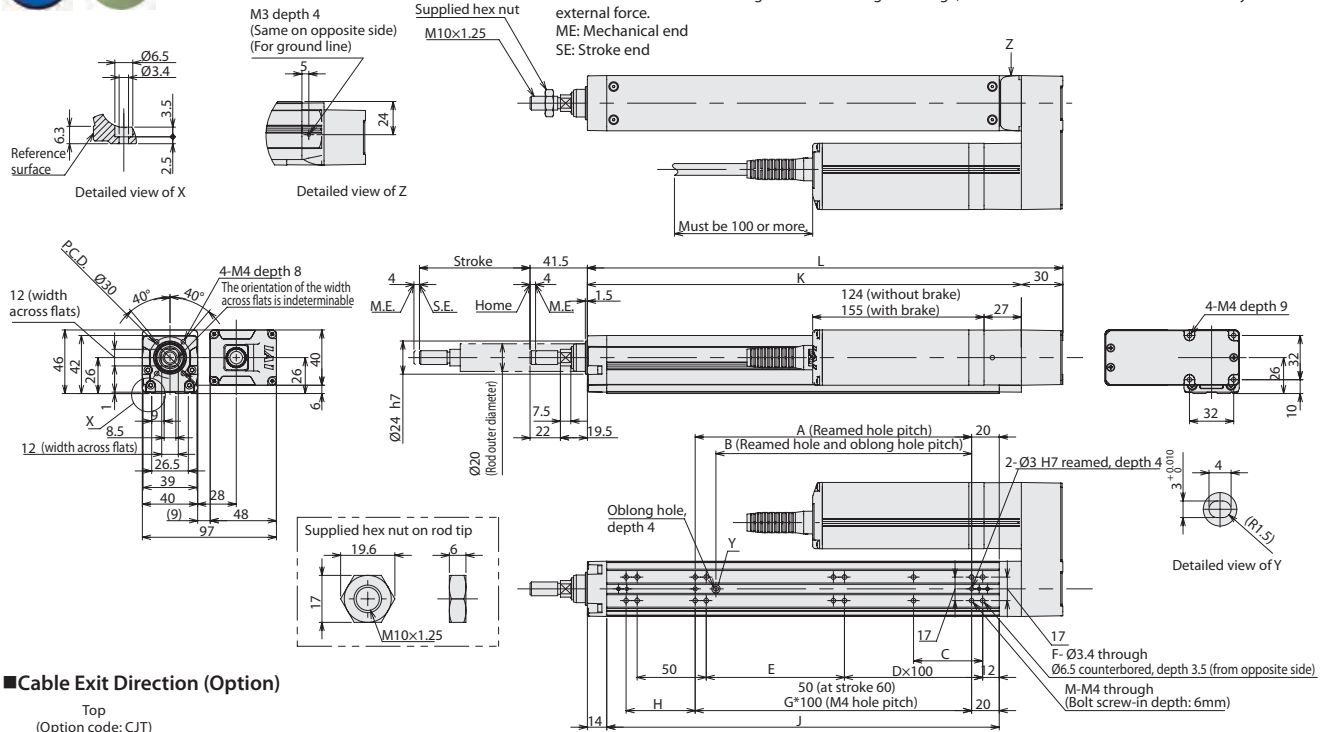

■ Cable Exit Direction (Option)

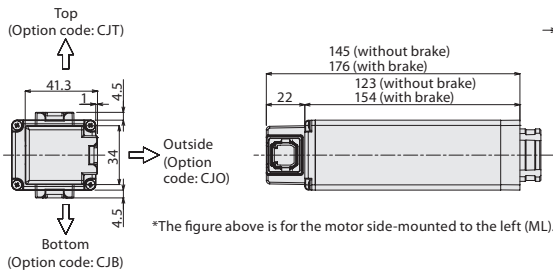

■ Rod Deflection of RCP5-RA4R (Reference Values)

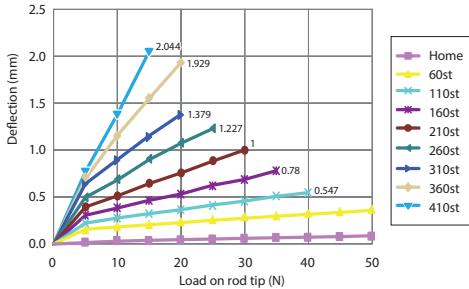

■ Dimensions and Mass by Stroke

Stroke	60	110	160	210	260	310	360	410
L	194	244	294	344	394	444	494	544
A	50	100	100	200	200	300	300	400
B	35	85	85	185	185	285	285	385
C	25	50	50	50	50	50	50	50
D	0	0	1	1	2	2	3	3
E	50	100	50	100	50	100	50	100
F	8	8	10	10	12	12	14	14
G	-	1	1	2	2	3	3	4
H	50	50	100	50	100	50	100	50
J	134	184	234	284	334	384	434	484
K	164	214	264	314	364	414	464	514
M	6	6	6	8	8	10	10	12
Allowable static load on rod tip (N)	55.8	44.6	37.1	31.7	27.6	24.3	21.7	19.5
Allowable dynamic load on rod tip (N)	Load offset 0mm	25.4	19.5	15.5	12.8	10.8	9.2	7.9
	Load offset 100mm	16.5	14.5	12.4	10.7	9.2	8.0	7.0
Allowable static torque on rod tip (N-m)	5.6	4.5	3.8	3.2	2.8	2.5	2.3	2.1
Allowable dynamic torque on rod tip (N-m)	1.7	1.5	1.2	1.1	0.9	0.8	0.7	0.6
Mass (kg)	Without brake	1.4	1.5	1.6	1.7	1.9	2.0	2.1
	With brake	1.6	1.7	1.8	1.9	2.1	2.2	2.3

Applicable Controllers

The RCP5 series actuators can be operated by the controllers indicated below. Please select the type depending on your intended use.

Name	External view	Model number	Max. number of controlled axes	Maximum number of positioning points	Input power	Standard price	Reference page
Positioner type (High-output specification)		PCON-CA-35PWAI-①-2-0	1	512 points	DC24V	-	→P.69
Pulse train type (High-output specification)		PCON-CA-35PWAI-PL②-2-0					
Network type (High-output specification)		PCON-CA-35PWAI-③-0-0					
Solenoid valve multi-axis type (PIO specification)		MSEP-④-⑤-⑥-⑦-⑧-⑨-⑩-2-0	4 (when high-output enabled) LC: 6 (3 when high-output enabled)	3 points	Single-phase AC 100V~230V	-	→P.77
Solenoid valve multi-axis type (Network specification)		MSEP-④-⑤-⑥-⑦-⑧-⑨-⑩-0-0					
Program control multi-axis type		MSEL-PC-1-35PWAI-①-2-4	4	30,000 points	Single-phase AC 100V~230V	-	→P.87
Program control multi-axis type (w/network board)		MSEL-PC-1-35PWAI-②-0-4					
Program control multi-axis type (Safety category compliant spec.)		MSEL-PG-1-35PWAI-③-2-4					
Program control multi-axis type (Safety category compliant spec. w/network board)		MSEL-PG-1-35PWAI-④-0-4					

*Above MSEL models are for single-axis specification
 *① I/O type (NP/PN)
 *② Field network specification code
 *③ Number of axes
 *④ N (NPN specification) or P (PNP specification) code
 *The high output enabled operation is only available when the "High-output setting specs" is selected in the MSEP-C/LC.

RCP5-RA6R

ROBO Cylinder, Rod Type, Side-mounted Motor Type, Actuator Width 58mm, 24V Pulse Motor

Model	RCP5	RA6R	WA	42P			P3		
Specification Items	Series	Type	Encoder type	Motor type	Lead	Stroke	Applicable controllers	Cable length	Options
			WA: Battery-less absolute specification	42P: Pulse motor, size 42□	20: 20mm 12: 12mm 6: 6mm 3: 3mm	65: 65mm 415: 415mm (Every 50mm)	P3: PCON-CA MSEP MSEL	N: No cable P: 1m S: 3m M: 5m X□: Specified length R□: Robot cable	Please refer to the options table below.

*Controller is not included.

Radial Load Applicable

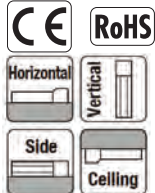

* Depending on the model, there may be some limitations to using the vertical mount position. Please refer to P.59 for details.

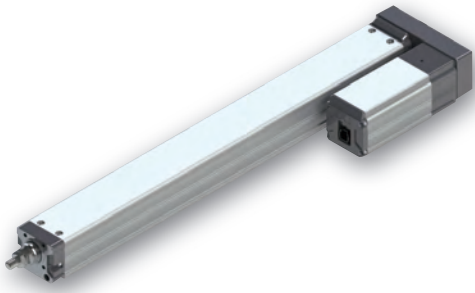

The figure above is the motor side-mounted to the left (ML).

POINT
Note on selection

- The actuator specification displays the payload's maximum value, but it will vary depending on the acceleration. Please refer to the "Selection Guidelines" (RCP5 Payload by Speed/Acceleration Table) on P. 61.
- Please refer to P. 59 for push-motion operation.
- The radial cylinder is equipped with a built-in guide. Please refer to the graphs shown in P. 65 and after for the allowable load mass.

Correlation Diagrams of Speed and Payload

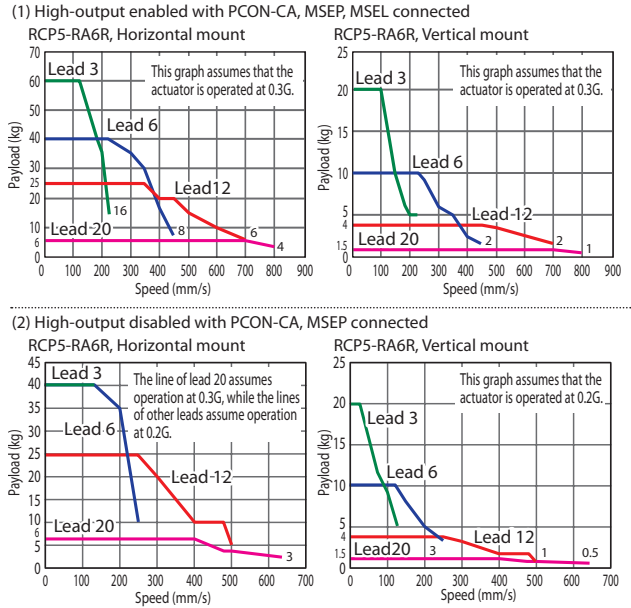

Actuator Specifications

Lead and Payload

Model number	Lead (mm)	Connected controller	Maximum payload		Maximum push force (N)	Stroke (mm)
			Horizontal (kg)	Vertical (kg)		
RCP5-RA6R-WA-42P-20-①-P3-②-③	20	High-output enabled	6	1.5	56	65~415 (Every 50mm)
		High-output disabled				
RCP5-RA6R-WA-42P-12-①-P3-②-③	12	High-output enabled	25	4	93	
		High-output disabled				
RCP5-RA6R-WA-42P-6-①-P3-②-③	6	High-output enabled	40	10	185	
		High-output disabled				
RCP5-RA6R-WA-42P-3-①-P3-②-③	3	High-output enabled	60	20	370	
		High-output disabled	40			

Legend: ① Stroke ② Cable length ③ Options *Please refer to P. 59 for push-motion operation.

Stroke and Maximum Speed

(Unit: mm/s)

Lead (mm)	Connected controller	65~365 (Every 50mm)		415 (mm)
		65~365 (Every 50mm)	415 (mm)	
20	High-output enabled	800		
	High-output disabled	640		
12	High-output enabled	700		
	High-output disabled	500		
6	High-output enabled	450		
	High-output disabled	250		
3	High-output enabled	225	220	
	High-output disabled	125		

① Stroke

Stroke (mm)	Standard price	Stroke (mm)	Standard price
65	-	265	-
115	-	315	-
165	-	365	-
215	-	415	-

③ Options

Name	Option code	Reference page	Standard price
Brake	B	→P. 11	-
Cable exit direction (Top)	CJT	→P. 11	-
Cable exit direction (Outside)	CJO	→P. 11	-
Cable exit direction (Bottom)	CJB	→P. 11	-
Flange	FL	→P. 12	-
Tip adapter (Flange)	FFA	→P. 12	-
Tip adapter (Internal thread)	NFA	→P. 13	-
Tip adapter (Keyway)	KFA	→P. 13	-
Motor side-mounted to the left (Standard)	ML	→P. 11	-
Motor side-mounted to the right	MR	→P. 11	-
Non-motor end specification	NM	→P. 11	-

Depending on the stroke, some rod attachment options are not available. Also, when selecting the shorter strokes, please be careful of nearby objects. Some interference may occur. Please refer to P. 14.

② Cable Length

Type	Cable code	Standard price
Standard type	P (1m)	-
	S (3m)	-
	M (5m)	-
Special length	X06 (6m) ~X10 (10m)	-
	X11 (11m)~X15 (15m)	-
	X16 (16m)~X20 (20m)	-
	R01 (1m) ~R03 (3m)	-
Robot cable	R04 (4m) ~R05 (5m)	-
	R06 (6m) ~R10 (10m)	-
	R11 (11m)~R15 (15m)	-
	R16 (16m)~R20 (20m)	-

*Please refer to P. 89 for maintenance cables.

Actuator Specifications

Item	Description
Drive system	Ball screw Ø10mm, rolled C10
Positioning repeatability (*1)	±0.02mm [±0.03mm]
Lost motion	0.1mm or less
Rod	Ø25mm Aluminum
Rod non-rotation precision (*2)	0 deg.
Allowable load and torque on rod tip	Refer to table in the page on the right, refer to P. 65
Rod tip overhang distance	100mm or less
Ambient operating temperature, humidity	0 to 40°C, 85% RH or less (Non-condensing)

(*1) The values in brackets [] are for Lead 20.

(*2) Rod's angular displacement in rotational direction with no applied load is shown.

Dimensions

CAD drawings can be downloaded from our website. www.intelligentactuator.com



- *1 When the rod is returning to its home position, please be careful of interference from surrounding objects, as it will travel until it reaches the ME.
- *2 The direction of width across flats varies depending on the product.
- *3 If the actuator is installed using the front housing and flange, make sure the actuator will not receive any external force.

ME: Mechanical end
SE: Stroke end

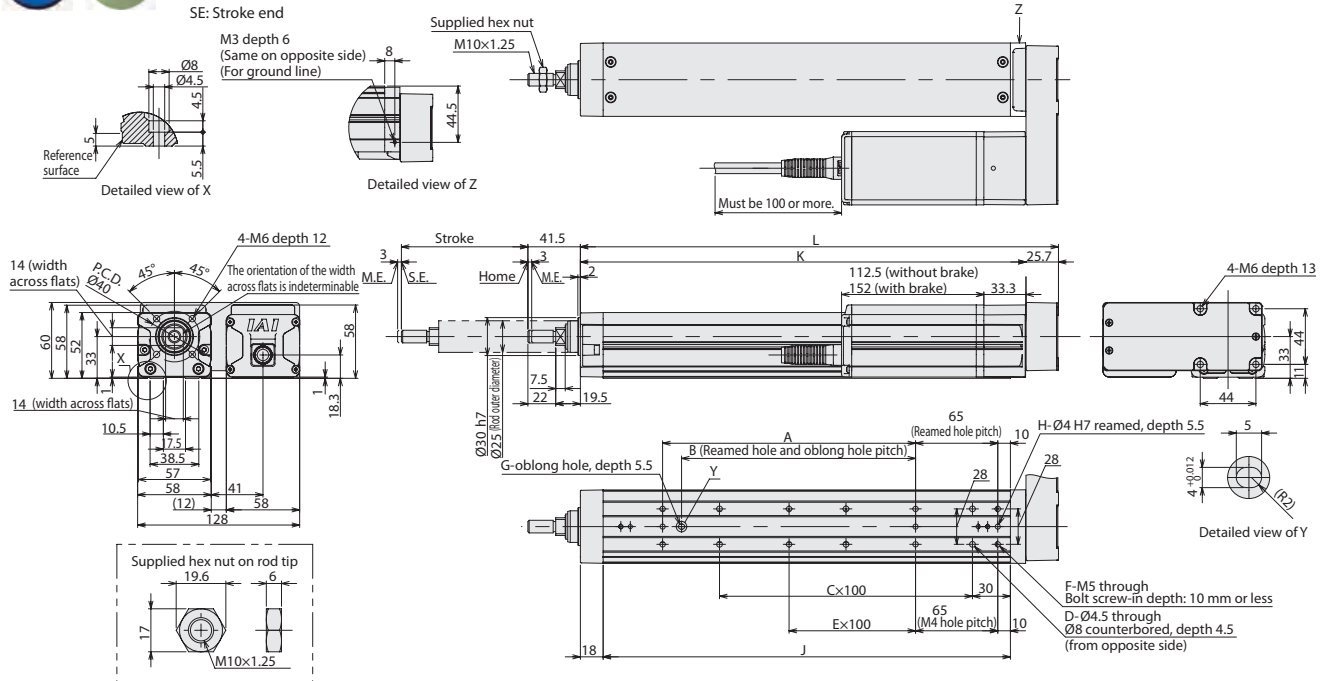

■ Cable Exit Direction (Option)

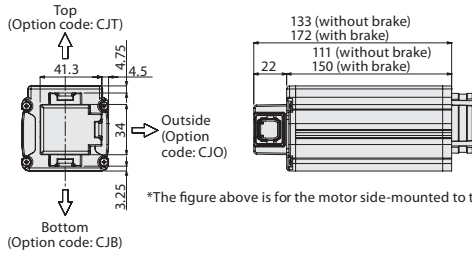

*The figure above is for the motor side-mounted to the left (ML).

■ Rod Deflection of RCP5-RA6R (Reference Values)

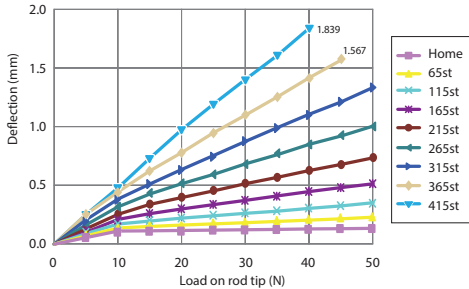

■ Dimensions and Mass by Stroke

Stroke	65	115	165	215	265	315	365	415
L	228	278	328	378	428	478	528	578
A	0	100	100	200	200	300	300	400
B	0	85	85	185	185	285	285	385
C	1	1	2	2	3	3	4	4
D	4	4	6	6	8	8	10	10
E	0	0	0	1	1	2	2	3
F	4	6	6	8	8	10	10	12
G	0	1	1	1	1	1	1	1
H	2	3	3	3	3	3	3	3
J	172	222	272	322	372	422	472	522
K	202.3	252.3	302.3	352.3	402.3	452.3	502.3	552.3
Allowable static load on rod tip (N)	113.8	92.6	78.0	67.3	59.0	52.5	47.2	42.8
Allowable dynamic load on rod tip (N)	45.7	36.3	29.8	25.1	21.6	18.8	16.6	14.7
Allowable static torque on rod tip (N-m)	3.2	2.8	2.5	2.1	1.9	1.7	1.5	1.3
Allowable dynamic torque on rod tip (N-m)	3.2	2.8	2.5	2.1	1.9	1.7	1.5	1.3
Mass (kg)	Without brake	2.2	2.4	2.6	2.8	3.0	3.3	3.5
	With brake	2.4	2.6	2.8	3.0	3.2	3.5	3.7

Applicable Controllers

The RCP5 series actuators can be operated by the controllers indicated below. Please select the type depending on your intended use.

Name	External view	Model number	Max. number of controlled axes	Maximum number of positioning points	Input power	Standard price	Reference page
Positioner type (High-output specification)		PCON-CA-42PWAI-①-2-0	1	512 points	DC24V	-	→P.69
Pulse train type (High-output specification)		PCON-CA-42PWAI-PL②-2-0				-	
Network type (High-output specification)		PCON-CA-42PWAI-③-0-0				-	
Solenoid valve multi-axis type (PIO specification)		MSEP-④-①-①-①-2-0	4 (4 when high-output enabled) LC: 6 (3 when high-output enabled)	3 points	Single-phase AC 100V~230V	-	→P.77
Solenoid valve multi-axis type (Network specification)		MSEP-④-①-①-①-0-0				256 points	
Program control multi-axis type		MSEL-PC-1-42PWAI-①-2-4	4	30,000 points	Single-phase AC 100V~230V	-	→P.87
Program control multi-axis type (w/network board)		MSEL-PC-1-42PWAI-②-0-4					
Program control multi-axis type (Safety category compliant spec.)		MSEL-PG-1-42PWAI-①-2-4					
Program control multi-axis type (Safety category compliant spec. w/network board)		MSEL-PG-1-42PWAI-②-0-4					

*Above MSEL models are for single-axis specification
 *① I/O type (NP/PN)
 *② Field network specification code
 *③ C or LC
 *④ Number of axes
 *⑤ N (NPN specification) or P (PNP specification) code
 *The high output enabled operation is only available when the "High-output setting specs" is selected in the MSEP-C/LC.

RCP5-RA7R ROBO Cylinder, Rod Type, Side-mounted Motor Type, Actuator Width 73mm, 24V Pulse Motor

Model	RCP5	RA7R	WA	56P			P3		
Specification	Series	Type	Encoder type	Motor type	Lead	Stroke	Applicable controllers	Cable length	Options
Items			WA: Battery-less absolute specification	56P: Pulse motor, size 56□	24: 24mm 16: 16mm 8: 8mm 4: 4mm	70: 70mm 520: 520mm (Every 50mm)	P3: PCON-CA MSEP MSEL	N: No cable P: 1m S: 3m M: 5m X□: Specified length R□: Robot cable	Please refer to the options table below.

*Controller is not included.

Radial Load Applicable

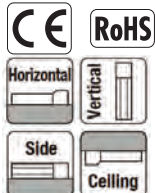

* Depending on the model, there may be some limitations to using the vertical mount position. Please refer to P.59 for details.

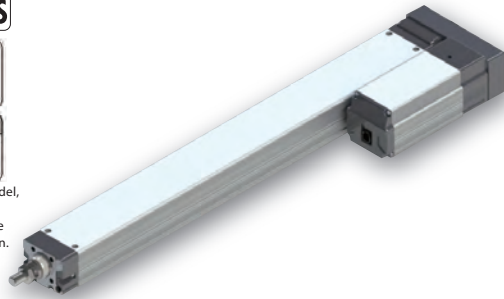

The figure above is the motor side-mounted to the left (ML).

POINT
Note on selection

- The actuator specification displays the payload's maximum value, but it will vary depending on the acceleration. Please refer to the "Selection Guidelines" (RCP5 Payload by Speed/Acceleration Table) on P. 61.
- Please refer to P. 59 for push-motion operation.
- The radial cylinder is equipped with a built-in guide. Please refer to the graphs shown in P. 65 and after for the allowable load mass.

Correlation Diagrams of Speed and Payload

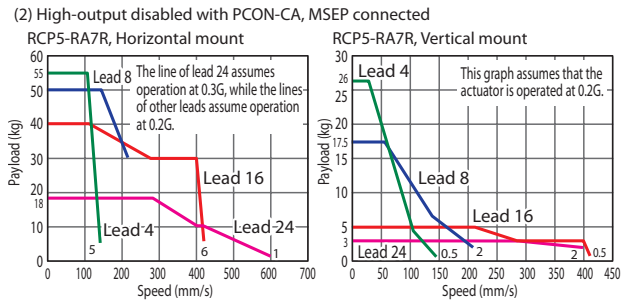
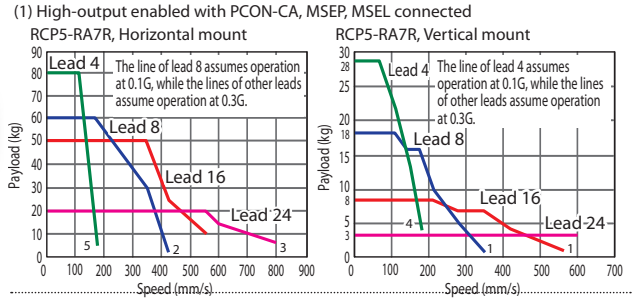

Actuator Specifications

Lead and Payload

Model number	Lead (mm)	Connected controller	Maximum payload		Maximum push force (N)	Stroke (mm)
			Horizontal (kg)	Vertical (kg)		
RCP5-RA7R-WA-56P-24-①-P3-②-③	24	High-output enabled	20	3	182	70~520 (Every 50mm)
		High-output disabled	18	3		
RCP5-RA7R-WA-56P-16-①-P3-②-③	16	High-output enabled	50	8	273	
		High-output disabled	40	5		
RCP5-RA7R-WA-56P-8-①-P3-②-③	8	High-output enabled	60	18	547	
		High-output disabled	50	17.5		
RCP5-RA7R-WA-56P-4-①-P3-②-③	4	High-output enabled	80	28	1,094	
		High-output disabled	55	26		

Legend: ① Stroke ② Cable length ③ Options *Please refer to P. 59 for push-motion operation.

Stroke and Maximum Speed

Values in brackets < > are for vertical use. (Unit: mm/s)

Lead (mm)	Connected controller	70~520 (Every 50mm)
24	High-output enabled	800 <600>
	High-output disabled	600 <400>
16	High-output enabled	560
	High-output disabled	420
8	High-output enabled	420 <350>
	High-output disabled	210
4	High-output enabled	175
	High-output disabled	140

① Stroke

Stroke (mm)	Standard price	Stroke (mm)	Standard price
70	-	320	-
120	-	370	-
170	-	420	-
220	-	470	-
270	-	520	-

③ Options

Name	Option code	Reference page	Standard price
Brake	B	→P. 11	-
Cable exit direction (Top)	CJT	→P. 11	-
Cable exit direction (Outside)	CJO	→P. 11	-
Cable exit direction (Bottom)	CJB	→P. 11	-
Flange	FL	→P. 12	-
Tip adapter (Flange)	FFA	→P. 12	-
Tip adapter (Internal thread)	NFA	→P. 13	-
Tip adapter (Keyway)	KFA	→P. 13	-
Motor side-mounted to the left (Standard)	ML	→P. 11	-
Motor side-mounted to the right	MR	→P. 11	-
Non-motor end specification	NM	→P. 11	-

Depending on the stroke, some rod attachment options are not available. Also, when selecting the shorter strokes, please be careful of nearby objects. Some interference may occur. Please refer to P. 14.

② Cable Length

Type	Cable code	Standard price
Standard type	P (1m)	-
	S (3m)	-
	M (5m)	-
Special length	X06 (6m) ~X10 (10m)	-
	X11 (11m)~X15 (15m)	-
	X16 (16m)~X20 (20m)	-
	R01 (1m) ~R03 (3m)	-
Robot cable	R04 (4m) ~R05 (5m)	-
	R06 (6m) ~R10 (10m)	-
	R11 (11m)~R15 (15m)	-
	R16 (16m)~R20 (20m)	-

*Please refer to P. 89 for maintenance cables.

Actuator Specifications

Item	Description
Drive system	Ball screw Ø12mm, rolled C10
Positioning repeatability (*1)	±0.02mm [±0.03mm]
Lost motion	0.1mm or less
Rod	Ø30mm Aluminum
Rod non-rotation precision (*2)	0 deg.
Allowable load and torque on rod tip	Refer to table in the page on the right, refer to P. 65
Rod tip overhang distance	100mm or less
Ambient operating temperature, humidity	0 to 40°C, 85% RH or less (Non-condensing)

(*1) The values in brackets [] are for Lead 24.

(*2) Rod's angular displacement in rotational direction with no applied load is shown.

Dimensions

CAD drawings can be downloaded from our website. www.intelligentactuator.com



- *1 When the rod is returning to its home position, please be careful of interference from surrounding objects, as it will travel until it reaches the ME.
- *2 The direction of width across flats varies depending on the product.
- *3 If the actuator is installed using the front housing and flange, make sure the actuator will not receive any external force.

ME: Mechanical end
SE: Stroke end

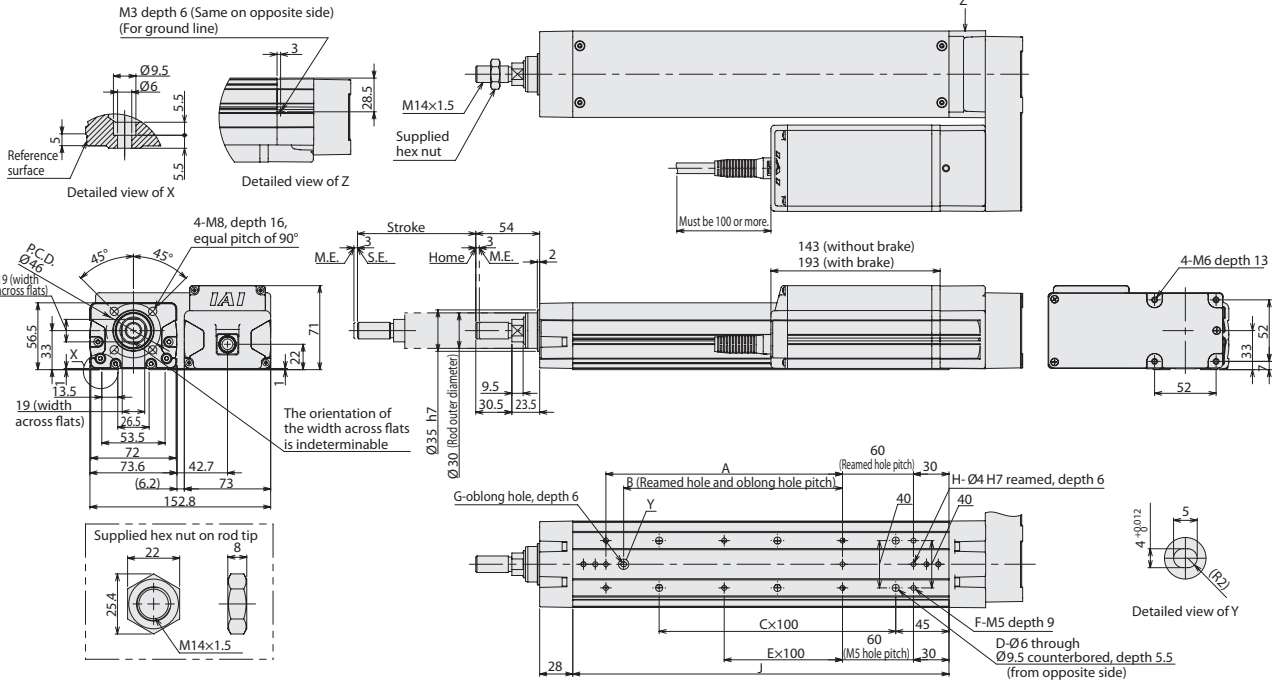

■ Cable Exit Direction (Option)

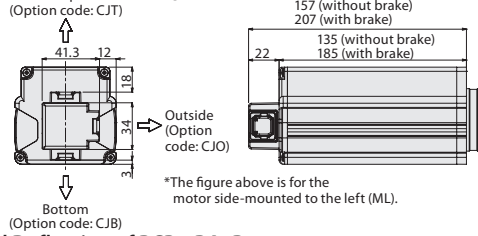

*The figure above is for the motor side-mounted to the left (ML).

■ Rod Deflection of RCP5-RA7R

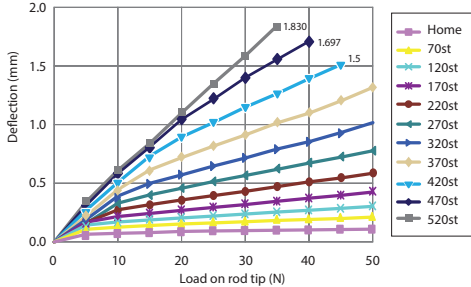

■ Dimensions and Mass by Stroke

Stroke	70	120	170	220	270	320	370	420	470	520
L	258	308	358	408	458	508	558	608	658	708
A	0	100	100	200	200	300	300	400	400	500
B	0	85	85	185	185	285	285	385	385	485
C	1	1	2	2	3	3	4	4	5	5
D	4	4	6	6	8	8	10	10	12	12
E	0	0	0	1	1	2	2	3	3	4
F	4	6	6	8	8	10	10	12	12	14
G	0	1	1	1	1	1	1	1	1	1
H	2	3	3	3	3	3	3	3	3	3
J	168	218	268	318	368	418	468	518	568	618
K	227	277	327	377	427	477	527	577	627	677
Allowable static load on rod tip (N)	119.2	97.7	82.8	71.6	63.0	56.2	50.6	46.0	42.2	38.8
Allowable dynamic load on rod tip (N)	Load offset 0mm	44.3	35.7	29.6	25.2	21.7	19.0	16.8	15.0	13.6
	Load offset 100mm	33.9	29.7	25.7	22.4	19.7	17.4	15.5	14.0	12.8
Allowable static torque on rod tip (N·m)	12.1	10.0	8.5	7.4	6.5	5.9	5.3	4.9	4.5	4.1
Allowable dynamic torque on rod tip (N·m)	3.4	3.0	2.6	2.2	2.0	1.7	1.6	1.4	1.3	1.2
Mass (kg)	Without brake	4.0	4.3	4.6	4.9	5.2	5.5	5.8	6.1	6.3
	With brake	4.5	4.8	5.1	5.4	5.7	6.0	6.3	6.6	6.8

Applicable Controllers

The RCP5 series actuators can be operated by the controllers indicated below. Please select the type depending on your intended use.

Name	External view	Model number	Max. number of controlled axes	Maximum number of positioning points	Input power	Standard price	Reference page
Positioner type (High-output specification)		PCON-CA-56PWAI-①-2-0	1	512 points	DC24V	-	→P.69
Pulse train type (High-output specification)		PCON-CA-56PWAI-PL⑤-2-0				-	
Network type (High-output specification)		PCON-CA-56PWAI-③-0-0				-	
Solenoid valve multi-axis type (PIO specification)		MSEP-④-①-①-①-2-0	4 (4 when high-output enabled) LC: 6 (3 when high-output enabled)	3 points	Single-phase AC 100V~230V	-	→P.77
Solenoid valve multi-axis type (Network specification)		MSEP-④-①-①-③-0-0				256 points	
Program control multi-axis type		MSEL-PC-1-56PWAI-①-2-4	4	30,000 points	Single-phase AC 100V~230V	-	→P.87
Program control multi-axis type (w/network board)		MSEL-PC-1-56PWAI-③-0-4					
Program control multi-axis type (Safety category compliant spec.)		MSEL-PG-1-56PWAI-①-2-4					
Program control multi-axis type (Safety category compliant spec. w/network board)		MSEL-PG-1-56PWAI-③-0-4					

*Above MSEL models are for single-axis specification *① I/O type (NP/PN) *③ Number of axes
 *④ Field network specification code *⑤ C or LC *⑤ N (NPN specification) or P (PNP specification) code
 *The high output enabled operation is only available when the "High-output setting specs" is selected in the MSEP-C/LC.

RCP5-RA8R ROBO Cylinder, High-thrust Rod Type, Side-mounted Motor Type, Actuator Width 88mm, 24V Pulse Motor

Model	RCP5	RA8R	WA	60P			P4		
Specification Items	Series	Type	Encoder type	Motor type	Lead	Stroke	Applicable controller	Cable length	Options
			WA: Battery-less absolute specification	60P: Pulse motor, size 60□	20: 20mm 10: 10mm 5: 5mm	50: 50mm 700: 700mm (Every 50mm)	P4: PCON-CFA	N: No cable P: 1m S: 3m M: 5m X□: Specified length R□: Robot cable	Please refer to the options table below.

*Controller is not included.

Radial Load Applicable

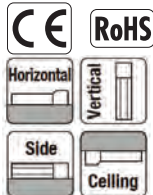

* Depending on the model, there may be some limitations to using the vertical mount position. Please refer to P.59 for details.

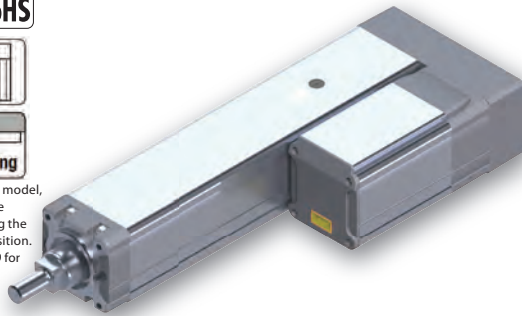

The figure above is the motor side-mounted to the left (ML).

- POINT**
Note on selection
- (1) The payload assumes operation at an acceleration of 0.1G for lead 5 and operation at an acceleration of 0.2G for lead 10 and lead 20. The above values are the upper limits of acceleration/deceleration.
 - (2) Please note that the RA8R requires a dedicated controller (high-thrust PCON-CFA).
 - (3) The radial cylinder is equipped with a built-in guide. Please refer to the graphs shown in P. 65 and after for the allowable load mass.

Correlation Diagrams of Speed and Payload

RCP5-RA8R, Horizontal mount, PCON-CFA connected

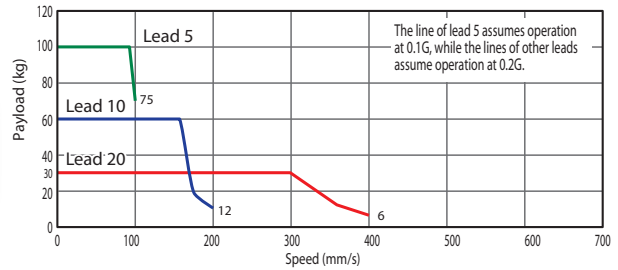

RCP5-RA8R, Vertical mount, PCON-CFA connected

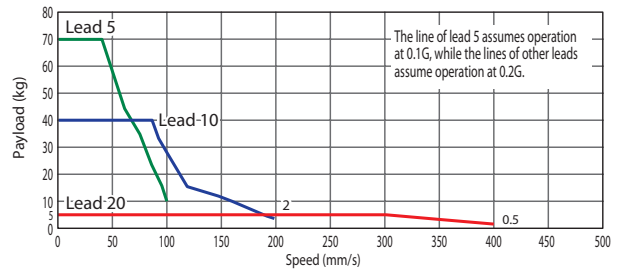

Actuator Specifications

Lead and Payload

Model number	Lead (mm)	Connected controller	Maximum payload		Maximum push force (N)	Stroke (mm)
			Horizontal (kg)	Vertical (kg)		
RCP5-RA8R-WA-60P-20-①-P4-②-③	20	PCON-CFA	30	5	500	50~700 (Every 50mm)
RCP5-RA8R-WA-60P-10-①-P4-②-③	10	PCON-CFA	60	40	1,000	
RCP5-RA8R-WA-60P-5-①-P4-②-③	5	PCON-CFA	100	70	2,000	

Legend: ① Stroke ② Cable length ③ Options *Please refer to P. 59 for push-motion operation.

Stroke and Maximum Speed

(Unit: mm/s)

Lead (mm)	50 (mm)	100~450 (mm)	500 (mm)	550 (mm)	600 (mm)	650 (mm)	700 (mm)
20	280	400	360	320	280	240	220
10	200	180	160	140	120	110	
5	100	90	80	70	60	55	

① Stroke

Stroke (mm)	Standard price	Stroke (mm)	Standard price
50	-	400	-
100	-	450	-
150	-	500	-
200	-	550	-
250	-	600	-
300	-	650	-
350	-	700	-

② Cable Length

Type	Cable code	Standard price
Standard type	P (1m)	-
	S (3m)	-
	M (5m)	-
Special length	X06 (6m) ~X10 (10m)	-
	X11 (11m)~X15 (15m)	-
	X16 (16m)~X20 (20m)	-
	R01 (1m) ~R03 (3m)	-
Robot cable	R04 (4m) ~R05 (5m)	-
	R06 (6m) ~R10 (10m)	-
	R11 (11m)~R15 (15m)	-
	R16 (16m)~R20 (20m)	-

*Please refer to P. 89 for maintenance cables.

③ Options

Name	Option code	Reference page	Standard price
Brake	B	→P. 11	-
Cable exit direction (Top)	CJT	→P. 11	-
Cable exit direction (Outside)	CJO	→P. 11	-
Cable exit direction (Bottom)	CJB	→P. 11	-
Motor side-mounted to the left (Standard)	ML	→P. 11	-
Motor side-mounted to the right	MR	→P. 11	-
Flange	FL	→P. 12	-
Non-motor end specification	NM	→P. 11	-

Actuator Specifications

Item	Description
Drive system	Ball screw Ø16mm, rolled C10
Positioning repeatability	±0.02mm
Lost motion	0.1mm or less
Rod	Ø40mm Aluminum
Rod non-rotation precision (*1)	0 deg.
Allowable load and torque on rod tip	Refer to table in the page on the right, refer to P. 65
Rod tip overhang distance	100mm or less
Ambient operating temperature, humidity	0 to 40°C, 85% RH or less (Non-condensing)

(*1) Rod's angular displacement in rotational direction with no applied load is shown.

Dimensions

CAD drawings can be downloaded from our website. www.intelligentactuator.com



- *1 When the rod is returning to its home position, please be careful of interference from surrounding objects, as it will travel until it reaches the ME.
 - *2 The direction of width across flats varies depending on the product.
 - *3 If the actuator is installed using the front housing and flange, make sure the actuator will not receive any external force.
- ME: Mechanical end
SE: Stroke end

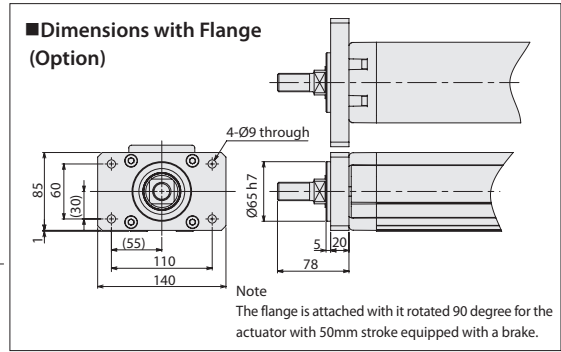
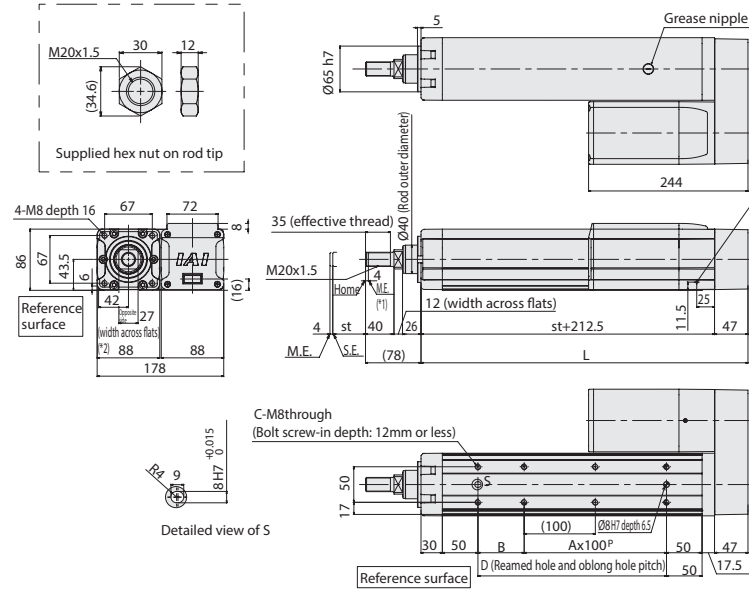

Dimensions with Brake (Option)

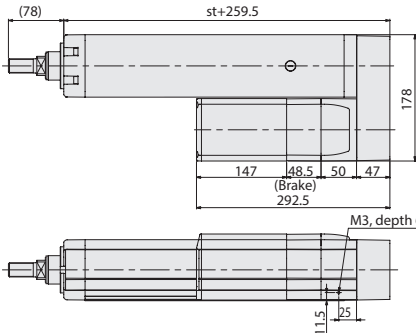

3 Cable Exit Directions (Option)

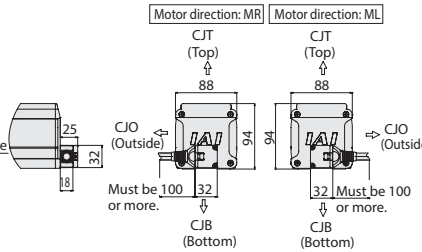

Note
If an actuator with lead 5 is installed vertically, the service life of the actuator varies significantly depending on its payload. Please refer to the correlation diagram of vertical load and traveling life shown below.
(If the actuator is installed horizontally, its service life is not affected by the payload.)

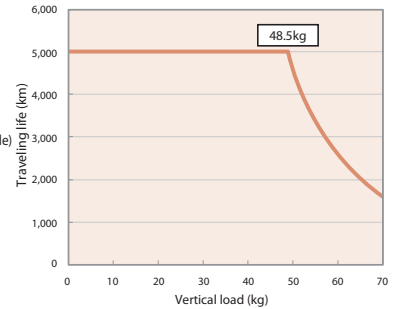

Rod Deflection of RCP5-RA8R

(The graph below shows the measurements of how much a horizontally installed rod would deflect when a load is applied to the end of the rod. The measured deflection includes the deflection due to the weight of the rod.)

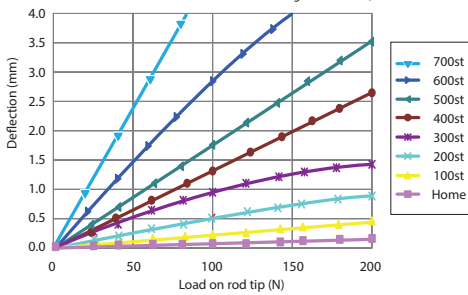

Dimensions and Mass by Stroke

Stroke	50	100	150	200	250	300	350	400	450	500	550	600	650	700	
L	309.5	359.5	409.5	459.5	509.5	559.5	609.5	659.5	709.5	759.5	809.5	859.5	909.5	959.5	
A	0	1	1	2	2	3	3	4	4	5	5	6	6	7	
B	115	65	115	65	115	65	115	65	115	65	115	65	115	65	
C	4	6	6	8	8	10	10	12	12	14	14	16	16	18	
D	115	165	215	265	315	365	415	465	515	565	615	665	715	765	
Allowable static load on rod tip (N)	180	150.3	128.9	112.7	99.9	89.7	81.3	74.3	68.3	63.1	58.6	54.6	51.1	47.9	
	73.6	60.3	51.0	44.1	38.7	34.3	30.7	27.7	25.2	23.0	21.1	19.4	17.8	16.5	
Allowable dynamic load on rod tip (N)	57.0	48.6	42.5	37.8	33.8	30.5	27.6	25.2	23.1	21.2	19.5	18.1	16.7	15.5	
	18.1	15.2	13.0	11.4	10.2	9.2	8.4	7.7	7.1	6.6	6.1	5.8	5.4	5.1	
Allowable static torque on rod tip (N·m)	5.7	4.9	4.3	3.8	3.4	3.0	2.8	2.5	2.3	2.1	2.0	1.8	1.7	1.5	
Mass (kg)	Without brake	8.6	9.0	9.4	9.8	10.3	10.7	11.1	11.6	12.0	12.4	12.9	13.3	13.7	14.1
	With brake	9.6	10.0	10.4	10.9	11.3	11.7	12.2	12.6	13.0	13.4	13.9	14.3	14.7	15.2

Applicable Controllers

The RCP5 series actuators can be operated by the controllers indicated below. Please select the type depending on your intended use.

Name	External view	Model number	Maximum number of positioning points	Input power	Standard price	Reference page
Positioner type		PCON-CFA-60PWAI-NP-2-0 PCON-CFA-60PWAI-PN-2-0	512 points	DC24V	-	→P. 69
Pulse-train type		PCON-CFA-60PWAI-PLN-2-0 PCON-CFA-60PWAI-PLP-2-0	—		-	
Field network type		PCON-CFA-60PWAI-①-0-0	768 points		-	

*① Field network specification code (DV, CC, PR, CN, ML, EC, EP)

RCP5-RA10R ROBO Cylinder, High-thrust Rod Type, Side-mounted Motor Type, Actuator Width 108mm, 24V Pulse Motor

Model	RCP5	RA10R	WA	86P			P4		
Specification Items	Series	Type	Encoder type	Motor type	Lead	Stroke	Applicable controller	Cable length	Options
			WA: Battery-less absolute specification	86P: Pulse motor, size 86□	10: 10mm 5: 5mm 2.5: 2.5mm	50: 50mm 800: 800mm (Every 50mm)	P4: PCON-CFA	N: No cable P: 1m S: 3m M: 5m X□: Specified length R□: Robot cable	Please refer to the options table below.

*Controller is not included.

Radial Load Applicable

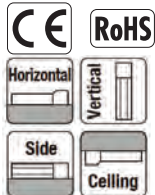

* Depending on the model, there may be some limitations to using the vertical mount position. Please refer to P.59 for details.

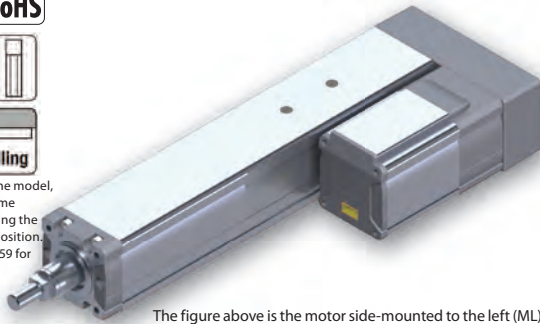

The figure above is the motor side-mounted to the left (ML).

- POINT**
Note on selection
- (1) The payload assumes operation at an acceleration of 0.01G for lead 2.5, operation at an acceleration of 0.02G for lead 5 and operation at an acceleration of 0.04G for lead 10. The above values are the upper limits of acceleration/deceleration.
 - (2) Please note that the RA10R requires a dedicated controller (high-thrust PCON-CFA).
 - (3) The radial cylinder is equipped with a built-in guide. Please refer to the graphs shown in P. 65 and after for the allowable load mass.

Correlation Diagrams of Speed and Payload

RCP5-RA10R, Horizontal mount, PCON-CFA connected

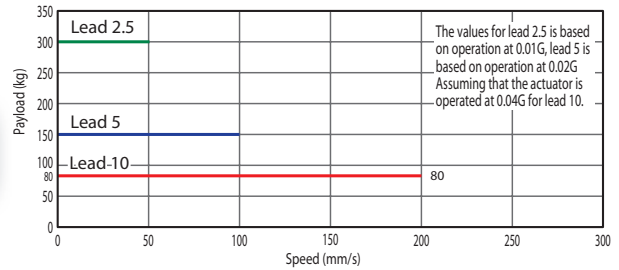

RCP5-RA10R, Vertical mount, PCON-CFA connected

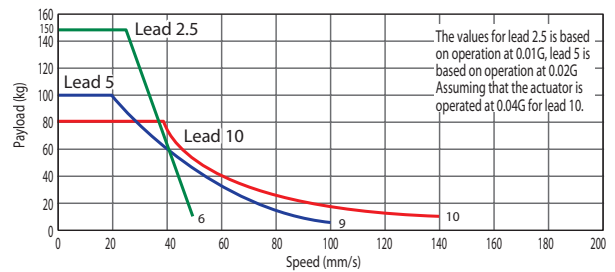

Actuator Specifications

Lead and Payload

Model number	Lead (mm)	Connected controller	Maximum payload		Maximum push force (N)	Stroke (mm)
			Horizontal (kg)	Vertical (kg)		
RCP5-RA10R-WA-86P-10-①-P4-②-③	10	PCON-CFA	80	80	1,500	50~800 (Every 50mm)
RCP5-RA10R-WA-86P-5-①-P4-②-③	5	PCON-CFA	150	100	3,000	
RCP5-RA10R-WA-86P-2.5-①-P4-②-③	2.5	PCON-CFA	300	150	6,000	

Legend: ① Stroke ② Cable length ③ Options *Please refer to P. 59 for push-motion operation.

Stroke and Maximum Speed

Values in brackets <> are for vertical use. (Unit: mm/s)

Lead (mm)	50 (mm)	100 (mm)	150 (mm)	200~400 (Every 50mm)	450 (mm)	500 (mm)	550 (mm)	600 (mm)	650 (mm)	700 (mm)	750 (mm)	800 (mm)
10	117	167 <140>		200 <140>					180 <140>	160 <140>	140	120
5	83		100		90	80	70	60	55	50	45	
2.5				50					45	40	35	30

① Stroke

Stroke (mm)	Standard price	Stroke (mm)	Standard price
50	-	450	-
100	-	500	-
150	-	550	-
200	-	600	-
250	-	650	-
300	-	700	-
350	-	750	-
400	-	800	-

② Cable Length

Type	Cable code	Standard price
Standard type	P (1m)	-
	S (3m)	-
	M (5m)	-
Special length	X06 (6m) ~X10 (10m)	-
	X11 (11m)~X15 (15m)	-
	X16 (16m)~X20 (20m)	-
	R01 (1m) ~R03 (3m)	-
Robot cable	R04 (4m) ~R05 (5m)	-
	R06 (6m) ~R10 (10m)	-
	R11 (11m)~R15 (15m)	-
	R16 (16m)~R20 (20m)	-

*Please refer to P. 89 for maintenance cables.

③ Options

Name	Option code	Reference page	Standard price
Brake	B	→P. 11	-
Cable exit direction (Top)	CJT	→P. 11	-
Cable exit direction (Outside)	CJO	→P. 11	-
Cable exit direction (Bottom)	CJB	→P. 11	-
Motor side-mounted to the left (Standard)	ML	→P. 11	-
Motor side-mounted to the right	MR	→P. 11	-
Flange	FL	→P. 12	-
Non-motor end specification	NM	→P. 11	-

Actuator Specifications

Item	Description
Drive system	Ball screw Ø20mm (Lead 2.5/10mm), Ø16mm (Lead 5mm), rolled C10
Positioning repeatability	±0.02mm
Lost motion	0.1mm or less
Rod	Ø40mm Aluminum
Rod non-rotation precision (*1)	0 deg.
Allowable load and torque on rod tip	Refer to table in the page on the right, refer to P. 65
Rod tip overhang distance	100mm or less
Ambient operating temperature, humidity	0 to 40°C, 85% RH or less (Non-condensing)

(*1) Rod's angular displacement in rotational direction with no applied load is shown.

Dimensions

CAD drawings can be downloaded from our website. www.intelligentactuator.com



- *1 When the rod is returning to its home position, please be careful of interference from surrounding objects, as it will travel until it reaches the ME.
 - *2 The direction of width across flats varies depending on the product.
 - *3 If the actuator is installed using the front housing and flange, make sure the actuator will not receive any external force.
- ME: Mechanical end
SE: Stroke end

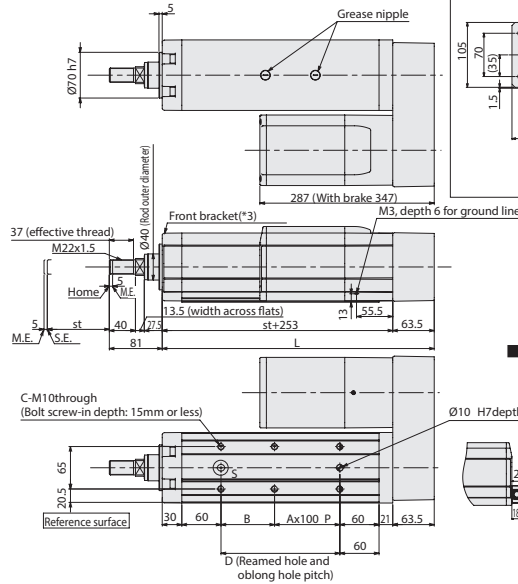
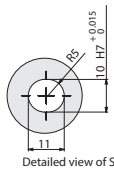
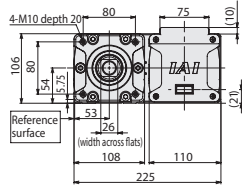
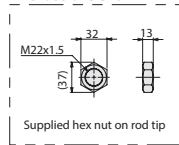

Dimensions with Flange (Option)

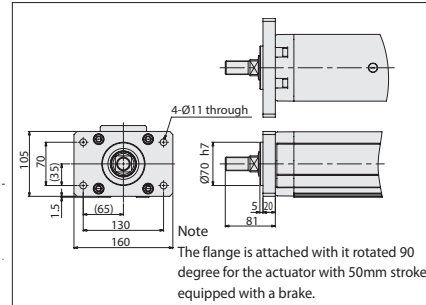

Note
The flange is attached with it rotated 90 degree for the actuator with 50mm stroke equipped with a brake.

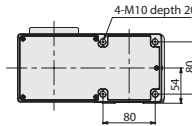

3 Cable Exit Directions (Option)

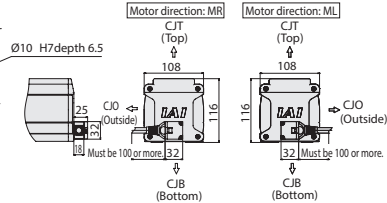

Rod Deflection of RCP5-RA10R

(The graph below shows the measurements of how much a horizontally installed rod would deflect when a load is applied to the end of the rod. The measured deflection includes the deflection due to the weight of the rod.)

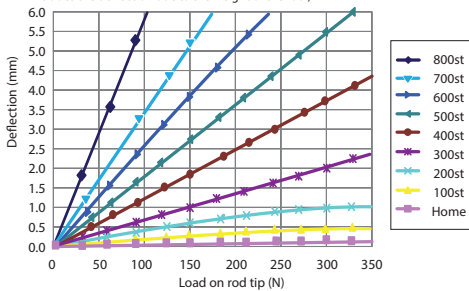

Dimensions and Mass by Stroke

Stroke	50	100	150	200	250	300	350	400	450	500	550	600	650	700	750	800
L	366.5	416.5	466.5	516.5	566.5	616.5	666.5	716.5	766.5	816.5	866.5	916.5	966.5	1,016.5	1,066.5	1,116.5
A	0	1	1	2	2	3	3	4	4	5	5	6	6	7	7	8
B	132	82	132	82	132	82	132	82	132	82	132	82	132	82	132	82
C	4	6	6	8	8	10	10	12	12	14	14	16	16	18	18	20
D	132	182	232	282	332	382	432	482	532	582	632	682	732	782	832	882
Allowable static load on rod tip (N)	316.9	268.4	232.6	205.1	183.4	165.7	151.0	138.6	128.1	119.0	111.0	103.9	97.7	92.1	87.0	82.5
Allowable dynamic load on rod tip (N)	Load offset 0mm	119.1	99.1	84.7	73.8	65.3	58.5	52.8	48.1	44.0	40.5	37.5	34.8	32.4	30.2	28.3
	Load offset 100mm	100.7	85.9	74.9	66.3	59.3	53.6	48.8	44.7	41.2	38.1	35.4	32.9	30.8	28.8	27.0
Allowable static torque on rod tip (N·m)	31.8	27.0	23.4	20.7	18.5	16.8	15.3	14.1	13.1	12.2	11.4	10.7	10.1	9.6	9.1	8.6
Allowable dynamic torque on rod tip (N·m)	10.1	8.6	7.5	6.6	5.9	5.4	4.9	4.5	4.1	3.8	3.5	3.3	3.1	2.9	2.7	2.5
Mass (kg)	Without brake	14.6	15.3	16.0	16.7	17.4	18.1	18.8	19.5	20.2	20.9	21.6	22.3	23.0	23.7	24.4
	With brake	16.2	16.9	17.6	18.3	19.0	19.7	20.4	21.1	21.8	22.5	23.2	23.9	24.6	25.3	26.0

Correlation Diagrams of Vertical Load and Traveling Life

- Since the RCP5-RA10R has a greater maximum thrust than other types, its service life varies significantly depending on the payload and push force applied when the actuator is installed vertically. When selecting an appropriate type from the correlation diagram of speed and payload or correlation diagram of push force and current-limiting value, check its traveling life on the correlation diagram of payload and service life as well as on the correlation diagram of push force and service life.

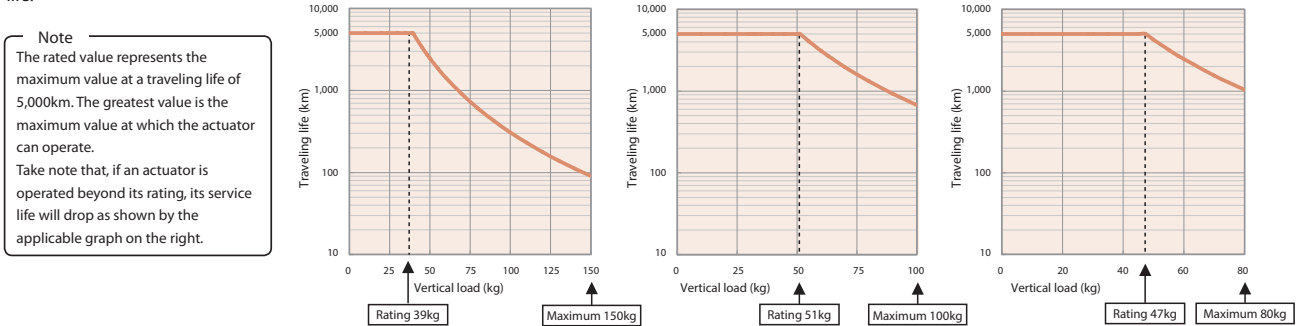

Applicable Controllers

The RCP5 series actuators can be operated by the controllers indicated below. Please select the type depending on your intended use.

Name	External view	Model number	Maximum number of positioning points	Input power	Standard price	Reference page
Positioner type		PCON-CFA-86PWAI-NP-2-0 PCON-CFA-86PWAI-PN-2-0	512 points	DC24V	-	→P. 69
Pulse-train type		PCON-CFA-86PWAI-PLN-2-0 PCON-CFA-86PWAI-PLP-2-0	—		-	
Field network type		PCON-CFA-86PWAI-①-0-0	768 points		-	

*① Field network specification code (DV, CC, PR, CN, ML, EC, EP)

RCP5CR-SA4C Cleanroom Type, ROBO Cylinder, Slider Type, Motor Unit Coupled, Actuator Width 40mm, 24V Pulse Motor

Model	RCP5CR	SA4C	WA	35P			P3		
Specification	Series	Type	Encoder type	Motor type	Lead	Stroke	Applicable controllers	Cable length	Options
Items			WA: Battery-less absolute specification	35P: Pulse motor, size 35□	16: 16mm 10: 10mm 5: 5mm 2.5: 2.5mm	50: 50mm 500: 500mm (Every 50mm)	P3: PCON-CA MSEP MSEL	N: No cable P: 1m S: 3m M: 5m X□: Specified length R□: Robot cable	Please refer to the options table below.

*Controller is not included.

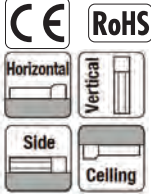

* Depending on the model, there may be some limitations to using the vertical, side, and ceiling mount positions. Please refer to P.59 for details.



- (1) The actuator specification displays the payload's maximum value, but it will vary depending on the acceleration. Please refer to the "Selection Guidelines" (RCP5 Payload by Speed/Acceleration Table) on P. 61.
- (2) Please refer to P. 59 for push-motion operation.

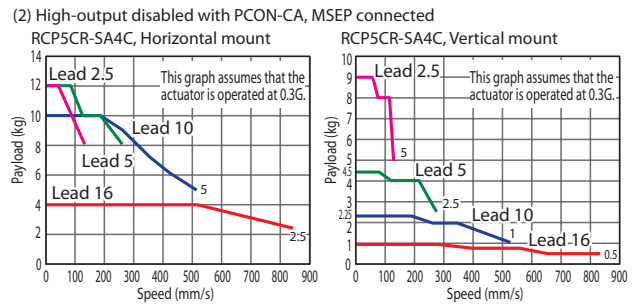
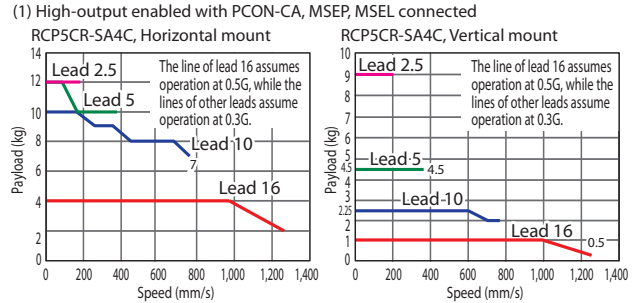

Actuator Specifications

Lead and Payload

Model number	Lead (mm)	Connected controller	Maximum payload		Stroke (mm)
			Horizontal (kg)	Vertical (kg)	
RCP5CR-SA4C-WA-35P-16-①-P3-②-③	16	High-output enabled	4	1	50~500 (Every 50mm)
		High-output disabled			
RCP5CR-SA4C-WA-35P-10-①-P3-②-③	10	High-output enabled	10	2.25	
		High-output disabled			
RCP5CR-SA4C-WA-35P-5-①-P3-②-③	5	High-output enabled	12	4.5	
		High-output disabled			
RCP5CR-SA4C-WA-35P-2.5-①-P3-②-③	2.5	High-output enabled	12	9	
		High-output disabled			

Legend: ① Stroke ② Cable length ③ Options *Please refer to P. 59 for push-motion operation.

① Stroke

Stroke (mm)	Standard price	Stroke (mm)	Standard price
50	-	300	-
100	-	350	-
150	-	400	-
200	-	450	-
250	-	500	-

Stroke, Max. Speed and Suction Amount (Unit: mm/s)

Lead (mm)	Connected controller	Stroke (mm)			Suction amount (Nl/min)
		50~400 (Every 50mm)	450 (mm)	500 (mm)	
16	High-output enabled	1,260	1,060	875	60
	High-output disabled	840			
10	High-output enabled	785	675	555	40
	High-output disabled	525			
5	High-output enabled	390	330	275	20
	High-output disabled	260			
2.5	High-output enabled	195	165	135	10
	High-output disabled	130			

② Cable Length

Type	Cable code	Standard price
Standard type	P (1m)	-
	S (3m)	-
	M (5m)	-
Special length	X06 (6m) ~X10 (10m)	-
	X11 (11m)~X15 (15m)	-
	X16 (16m)~X20 (20m)	-
	R01 (1m) ~R03 (3m)	-
Robot cable	R04 (4m) ~R05 (5m)	-
	R06 (6m) ~R10 (10m)	-
	R11 (11m)~R15 (15m)	-
	R16 (16m)~R20 (20m)	-

*Please refer to P. 89 for maintenance cables.

③ Options

Name	Option code	Reference page	Standard price
Brake	B	→P. 11	-
Cable exit direction (Top)	CJT	→P. 11	-
Cable exit direction (Right)	CJR	→P. 11	-
Cable exit direction (Left)	CJL	→P. 11	-
Cable exit direction (Bottom)	CJB	→P. 11	-
Non-motor end specification	NM	→P. 11	-
Vacuum joint on opposite side	VR	→P. 11	-

Actuator Specifications

Item	Description
Drive system	Ball screw Ø8mm, rolled C10
Positioning repeatability	±0.02mm
Lost motion	0.1mm or less
Base	Material: Aluminum with white alumite treatment
Dynamic allowable moment (*1)	Ma: 4.98N·m, Mb: 7.11N·m, Mc: 9.68N·m
Static allowable moment	Ma: 8.6N·m, Mb: 12.2N·m, Mc: 16.7N·m
Cleanliness	Class 10 (0.1µm)
Ambient operating temperature, humidity	0 to 40°C, 85% RH or less (Non-condensing)

*Reference for overhang load length/Ma: 120mm or less, Mb, Mc: 120mm or less

(*1) Assumes a standard rated life of 5,000km.

(*2) The operational life will vary depending on operation and installation conditions. Please refer to the general catalog for details on operational life, allowable moment direction, and overhang load length.

Dimensions

CAD drawings can be downloaded from our website. www.intelligentactuator.com



- *1 When the slider is returning to its home position, please be careful of interference from surrounding objects, as it will travel until it reaches the ME.
- ME: Mechanical end
- SE: Stroke end
- *2 There is no pipe joint for RCP5-SA4C Slider Roller Type (SR).

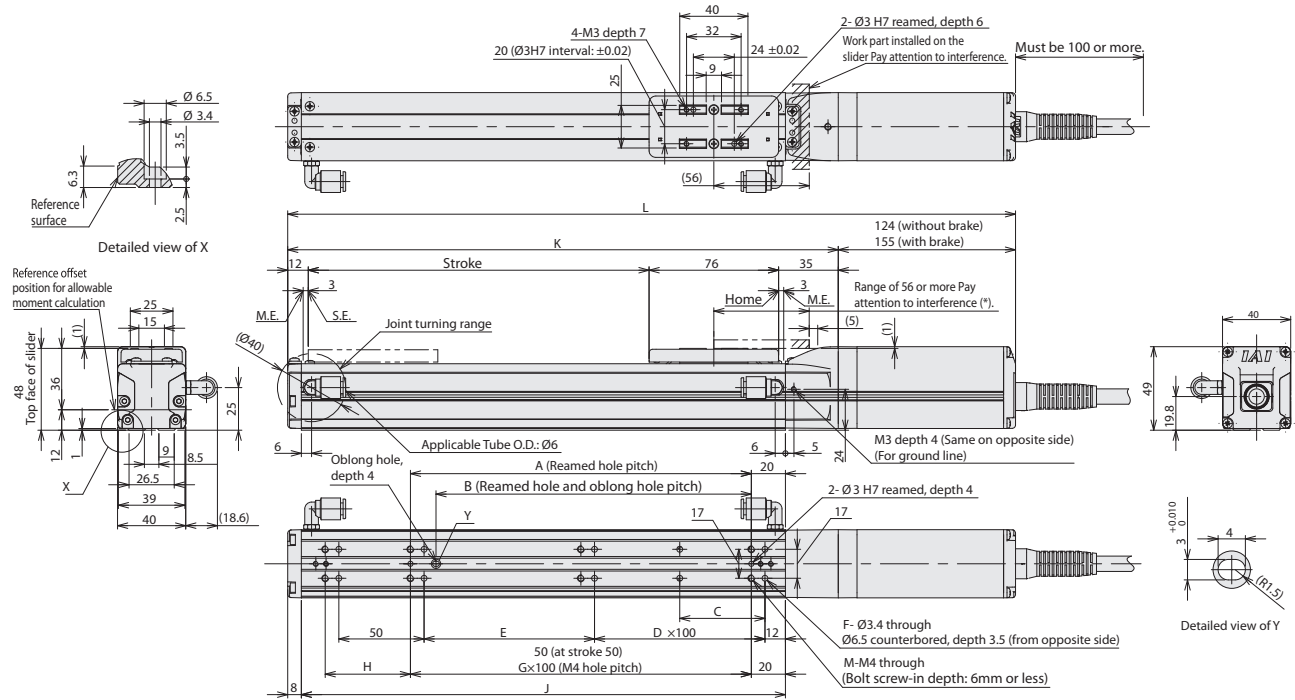

■ Cable Exit Direction (Option)

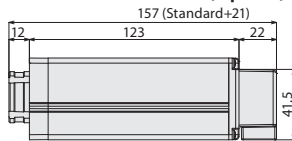

■ Dimensions and Mass by Stroke

Stroke	50	100	150	200	250	300	350	400	450	500
L	Without brake	297	347	397	447	497	547	597	647	747
	With brake	328	378	428	478	528	578	628	678	778
A	50	100	100	200	200	300	300	400	400	500
B	35	85	85	185	185	285	285	385	385	485
C	25	50	50	50	50	50	50	50	50	50
D	0	0	1	1	2	2	3	3	4	4
E	50	100	50	100	50	100	50	100	50	100
F	8	8	10	10	12	12	14	14	16	16
G	0	1	1	2	2	3	3	4	4	5
H	50	50	100	50	100	50	100	50	100	50
J	134	184	234	284	334	384	434	484	534	584
K	173	223	273	323	373	423	473	523	573	623
M	6	6	6	8	8	10	10	12	12	14
Mass (kg)	Without brake	1.0	1.1	1.2	1.3	1.3	1.4	1.5	1.6	1.7
	With brake	1.2	1.3	1.4	1.5	1.5	1.6	1.7	1.8	1.9

Applicable Controllers

The RCP5CR series actuators can be operated by the controllers indicated below. Please select the type depending on your intended use.

Name	External view	Model number	Max. number of controlled axes	Maximum number of positioning points	Input power	Standard price	Reference page
Positioner type (High-output specification)		PCON-CA-35PWAI-①-2-0	1	512 points	DC24V	-	→P.69
Pulse train type (High-output specification)		PCON-CA-35PWAI-PL②-2-0				-	
Network type (High-output specification)		PCON-CA-35PWAI-③-0-0				-	
Solenoid valve multi-axis type (PIO specification)		MSEL-④-⑤-⑥-⑦-⑧-2-0	C: 8 (4 when high-output enabled) LC: 6 (3 when high-output enabled)	3 points		-	→P.77
Solenoid valve multi-axis type (Network specification)		MSEL-④-⑤-⑥-⑦-⑧-0-0				256 points	
Program control multi-axis type		MSEL-PC-1-35PWAI-①-2-4	4	30,000 points	Single-phase AC 100V~230V	-	→P.87
Program control multi-axis type (w/network board)		MSEL-PC-1-35PWAI-②-0-4				-	
Program control multi-axis type (Safety category compliant spec.)		MSEL-PG-1-35PWAI-③-2-4				-	
Program control multi-axis type (Safety category compliant spec. w/network board)		MSEL-PG-1-35PWAI-④-0-4				-	

*Above MSEL models are for single-axis specification *① I/O type (NP/PN) *② Number of axes
 *③ Field network specification code *④ C or LC *⑤ N (NPN specification) or P (PNP specification) code
 *The high output enabled operation is only available when the "High-output setting specs" is selected in the MSEL-C/LC.

RCP5CR-SA6C

Cleanroom Type, ROBO Cylinder, Slider Type, Motor Unit Coupled, Actuator Width 58mm, 24V Pulse Motor

Model	RCP5CR	SA6C	WA	42P			P3		
Specification	Series	Type	Encoder type	Motor type	Lead	Stroke	Applicable controllers	Cable length	Options
Items			WA: Battery-less absolute specification	42P: Pulse motor, size 42□	20: 20mm 12: 12mm 6: 6mm 3: 3mm	50: 50mm 800: 800mm (Every 50mm)	P3: PCON-CA MSEP MSEL	N: No cable P: 1m S: 3m M: 5m X□: Specified length R□: Robot cable	Please refer to the options table below.

*Controller is not included.



* Depending on the model, there may be some limitations to using the vertical, side, and ceiling mount positions. Please refer to P.59 for details.



- The actuator specification displays the payload's maximum value, but it will vary depending on the acceleration. Please refer to the "Selection Guidelines" (RCP5 Payload by Speed/Acceleration Table) on P. 61.
- Please refer to P. 59 for push-motion operation.

Correlation Diagrams of Speed and Payload

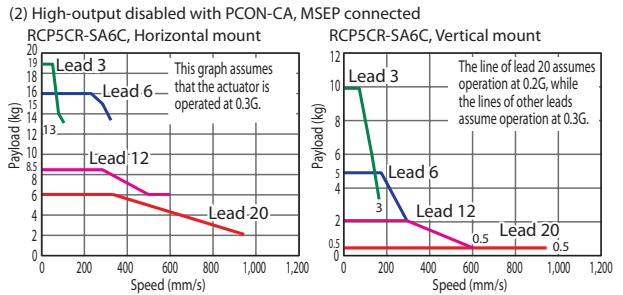
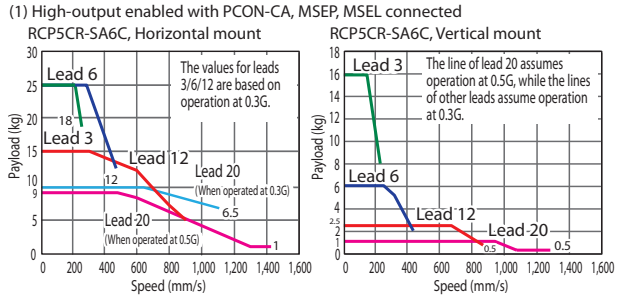

Actuator Specifications

Lead and Payload

Model number	Lead (mm)	Connected controller	Maximum payload		Stroke (mm)
			Horizontal (kg)	Vertical (kg)	
RCP5CR-SA6C-WA-42P-20-①-P3-②-③	20	High-output enabled	10	1	50~800 (Every 50mm)
		High-output disabled	6	0.5	
RCP5CR-SA6C-WA-42P-12-①-P3-②-③	12	High-output enabled	15	2.5	
		High-output disabled	8.5	2	
RCP5CR-SA6C-WA-42P-6-①-P3-②-③	6	High-output enabled	25	6	
		High-output disabled	16	5	
RCP5CR-SA6C-WA-42P-3-①-P3-②-③	3	High-output enabled	25	16	
		High-output disabled	19	10	

Legend: ① Stroke ② Cable length ③ Options *Please refer to P. 59 for push-motion operation.

Stroke, Max. Speed and Suction Amount

(Unit: mm/s)

Lead (mm)	Connected controller	Max. Speed (mm/s)										Suction amount (Nl/min)
		50~400 (Every 50mm)	450 (mm)	500 (mm)	550 (mm)	600 (mm)	650 (mm)	700 (mm)	750 (mm)	800 (mm)		
20	High-output enabled	1,440 <1,280>	1,335 <1,280>	1,130	970	840	735	650	575	100		
	High-output disabled	960						840	735		650	575
12	High-output enabled	900	885	735	620	535	460	405	315	70		
	High-output disabled	600			535	460	405	355	315			
6	High-output enabled	450	435	365	305	265	230	200	175	30		
	High-output disabled	300		265	230	200	175	155				
3	High-output enabled	225	215	180	150	130	115	100	85	15		
	High-output disabled	150		130	115	100	85	75				

Values in brackets < > are for vertical use.

① Stroke

Stroke (mm)	Standard price	Stroke (mm)	Standard price
50	-	450	-
100	-	500	-
150	-	550	-
200	-	600	-
250	-	650	-
300	-	700	-
350	-	750	-
400	-	800	-

② Cable Length

Type	Cable code	Standard price
Standard type	P (1m)	-
	S (3m)	-
	M (5m)	-
Special length	X06 (6m) ~X10 (10m)	-
	X11 (11m)~X15 (15m)	-
	X16 (16m)~X20 (20m)	-
	R01 (1m) ~R03 (3m)	-
Robot cable	R04 (4m) ~R05 (5m)	-
	R06 (6m) ~R10 (10m)	-
	R11 (11m)~R15 (15m)	-
	R16 (16m)~R20 (20m)	-

*Please refer to P. 89 for maintenance cables.

③ Options

Name	Option code	Reference page	Standard price
Brake	B	→P. 11	-
Cable exit direction (Top)	CJT	→P. 11	-
Cable exit direction (Right)	CJR	→P. 11	-
Cable exit direction (Left)	CJL	→P. 11	-
Cable exit direction (Bottom)	CJB	→P. 11	-
Non-motor end specification	NM	→P. 11	-
Vacuum joint on opposite side	VR	→P. 11	-

Actuator Specifications

Item	Description
Drive system	Ball screw Ø10mm, rolled C10
Positioning repeatability (*1)	±0.02mm [±0.03mm]
Lost motion	0.1mm or less
Base	Material: Aluminum with white alumite treatment
Dynamic allowable moment (*2)	Ma: 11.6N·m, Mb: 16.6N·m, Mc: 24.6N·m
Static allowable moment	Ma: 38.3N·m, Mb: 54.7N·m, Mc: 81N·m
Cleanliness	Class 10 (0.1µm)
Ambient operating temperature, humidity	0 to 40°C, 85% RH or less (Non-condensing)

*Reference for overhang load length/Ma: 150mm or less, Mb, Mc: 150mm or less

(*1) The values in brackets [] are for Lead 20.
(*2) Assumes a standard rated life of 5,000km.

(*3) The operational life will vary depending on operation and installation conditions. Please refer to the general catalog for details on operational life, allowable moment direction, and overhang load length.

Dimensions

CAD drawings can be downloaded from our website. www.intelligentactuator.com



- *1 When the slider is returning to its home position, please be careful of interference from surrounding objects, as it will travel until it reaches the ME.
- ME: Mechanical end
- SE: Stroke end
- *2 There is no pipe joint for RCP5-SA6C Slider Roller Type (SR).

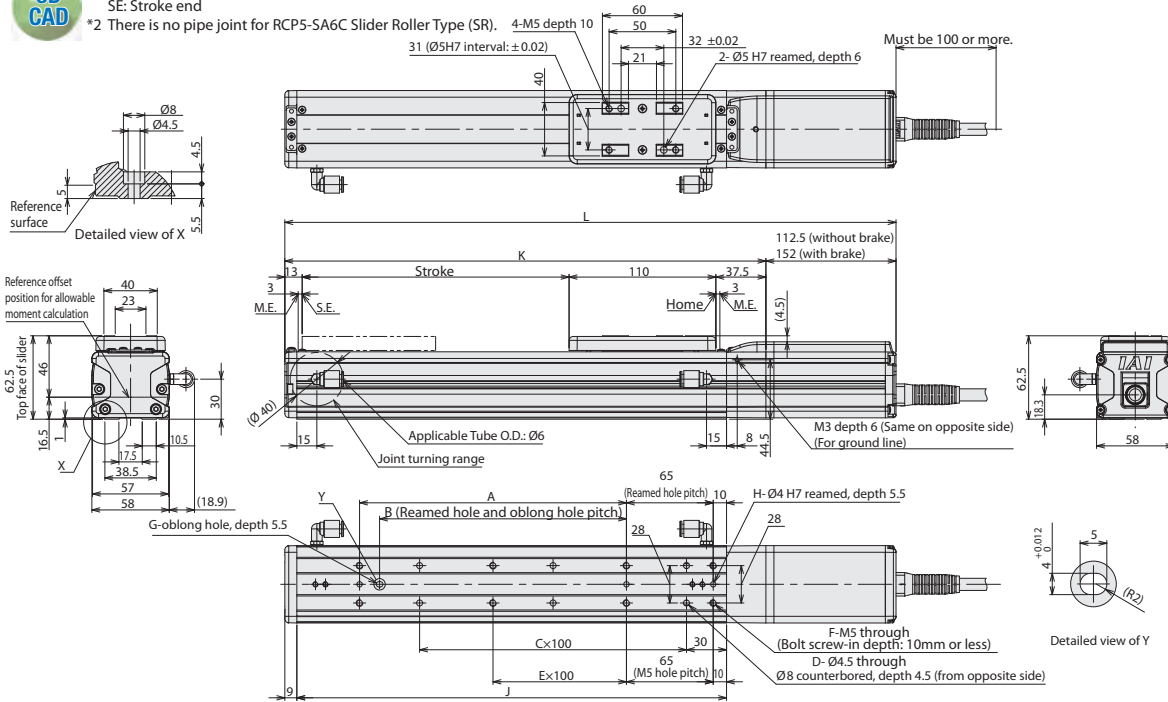

■ Cable Exit Direction (Option)

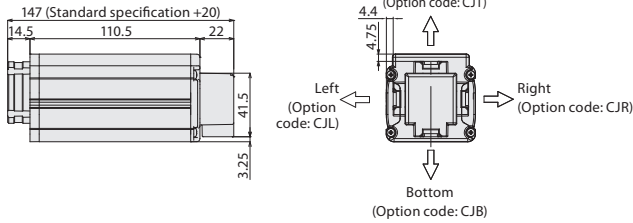

■ Dimensions and Mass by Stroke

L	Stroke	50	100	150	200	250	300	350	400	450	500	550	600	650	700	750	800
	Without brake	323	373	423	473	523	573	623	673	723	773	823	873	923	973	1,023	1,073
With brake	362.5	412.5	462.5	512.5	562.5	612.5	662.5	712.5	762.5	812.5	862.5	912.5	962.5	1,012.5	1,062.5	1,112.5	
A	0	100	100	200	200	300	300	400	400	500	500	600	600	700	700	800	
B	0	85	85	185	185	285	285	385	385	485	485	585	585	685	685	785	
C	1	1	2	2	3	3	4	4	5	5	6	6	7	7	8	8	
D	4	4	6	6	8	8	10	10	12	12	14	14	16	16	18	18	
E	0	0	0	1	1	2	2	3	3	4	4	5	5	6	6	7	
F	4	6	6	8	8	10	10	12	12	14	14	16	16	18	18	20	
G	0	1	1	1	1	1	1	1	1	1	1	1	1	1	1	1	
H	2	3	3	3	3	3	3	3	3	3	3	3	3	3	3	3	
J	172	222	272	322	372	422	472	522	572	622	672	722	772	822	872	922	
K	210.5	260.5	310.5	360.5	410.5	460.5	510.5	560.5	610.5	660.5	710.5	760.5	810.5	860.5	910.5	960.5	
Mass (kg)	Without brake	1.7	1.8	2.0	2.2	2.4	2.5	2.7	2.9	3.1	3.2	3.4	3.6	3.8	3.9	4.1	4.3
	With brake	1.9	2.0	2.2	2.4	2.6	2.7	2.9	3.1	3.3	3.4	3.6	3.8	4.0	4.1	4.3	4.5

Applicable Controllers

The RCP5CR series actuators can be operated by the controllers indicated below. Please select the type depending on your intended use.

Name	External view	Model number	Max. number of controlled axes	Maximum number of positioning points	Input power	Standard price	Reference page
Positioner type (High-output specification)		PCON-CA-42PWAI-①-2-0	1	512 points	DC24V	-	→P. 69
Pulse train type (High-output specification)		PCON-CA-42PWAI-PL②-2-0				-	
Network type (High-output specification)		PCON-CA-42PWAI-③-0-0				-	
Solenoid valve multi-axis type (PIO specification)		MSEL-④-⑤-⑥-⑦-2-0	C: 8 (4 when high-output enabled) LC: 6 (3 when high-output enabled)	3 points	Single-phase AC 100V~230V	-	→P. 77
Solenoid valve multi-axis type (Network specification)		MSEL-④-⑤-⑥-⑦-0-0				256 points	
Program control multi-axis type		MSEL-PC-1-42PWAI-①-2-4	4	30,000 points	Single-phase AC 100V~230V	-	→P. 87
Program control multi-axis type (w/network board)		MSEL-PC-1-42PWAI-②-0-4					
Program control multi-axis type (Safety category compliant spec.)		MSEL-PG-1-42PWAI-③-2-4					
Program control multi-axis type (Safety category compliant spec. w/network board)		MSEL-PG-1-42PWAI-④-0-4					

*Above MSEL models are for single-axis specification *① I/O type (NP/PN) *② Number of axes
 *③ Field network specification code *④ C or LC *⑤ N (NPN specification) or P (PNP specification) code
 *The high output enabled operation is only available when the "High-output setting specs" is selected in the MSEL-C/LC.

RCP5CR-SA7C

Cleanroom Type, ROBO Cylinder, Slider Type, Motor Unit Coupled, Actuator Width 73mm, 24V Pulse Motor

Model	RCP5CR	SA7C	WA	56P			P3		
Specification Items	Series	Type	Encoder type	Motor type	Lead	Stroke	Applicable controllers	Cable length	Options
			WA: Battery-less absolute specification	56P: Pulse motor, size 56□	24: 24mm 16: 16mm 8: 8mm 4: 4mm	50: 50mm 800: 800mm (Every 50mm)	P3: PCON-CA MSEP MSEL	N: No cable P: 1m S: 3m M: 5m X□: Specified length R□: Robot cable	Please refer to the options table below.

*Controller is not included.



* Depending on the model, there may be some limitations to using the vertical, side, and ceiling mount positions. Please refer to P.59 for details.

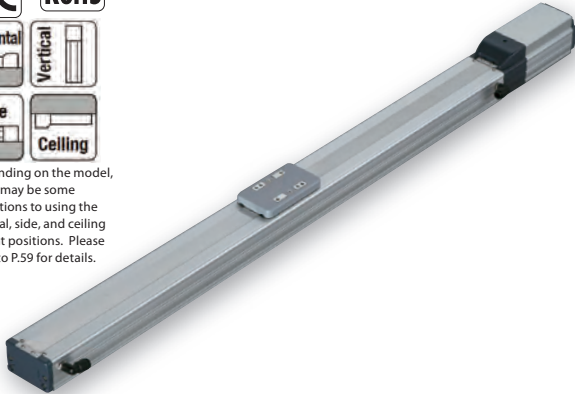

- The actuator specification displays the payload's maximum value, but it will vary depending on the acceleration. Please refer to the "Selection Guidelines" (RCP5 Payload by Speed/Acceleration Table) on P. 61.
- Please refer to P. 59 for push-motion operation.

Correlation Diagrams of Speed and Payload

(1) High-output enabled with PCON-CA, MSEP, MSEL connected

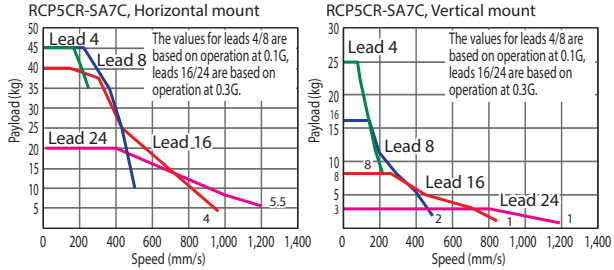

(2) High-output disabled with PCON-CA, MSEP connected

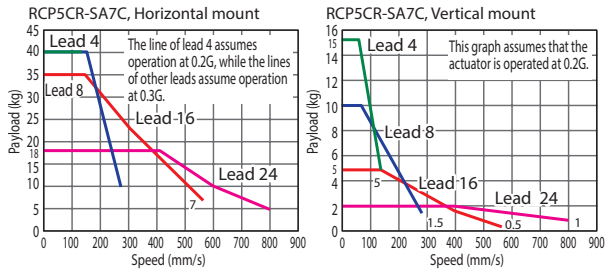

Actuator Specifications

Lead and Payload

Model number	Lead (mm)	Connected controller	Maximum payload		Stroke (mm)
			Horizontal (kg)	Vertical (kg)	
RCP5CR-SA7C-WA-56P-24-①-P3-②-③	24	High-output enabled	20	3	50~800 (Every 50mm)
		High-output disabled	18	2	
RCP5CR-SA7C-WA-56P-16-①-P3-②-③	16	High-output enabled	40	8	
		High-output disabled	35	5	
RCP5CR-SA7C-WA-56P-8-①-P3-②-③	8	High-output enabled	45	16	
		High-output disabled	40	10	
RCP5CR-SA7C-WA-56P-4-①-P3-②-③	4	High-output enabled	45	25	
		High-output disabled	40	15	

Legend: ① Stroke ② Cable length ③ Options *Please refer to P. 59 for push-motion operation.

Stroke, Max. Speed and Suction Amount

(Unit: mm/s)

Lead (mm)	Connected controller	Stroke (mm)						Suction amount (N2/mm)
		50~550 (Every 50mm)	600	650	700	750	800	
24	High-output enabled	1,200	1,145	1,000	885	785	90	
	High-output disabled	800						785
16	High-output enabled	980 (<840>)	875 (<840>)	755	660	585	70	
	High-output disabled	560						520
8	High-output enabled	490	430	375	325	290	40	
	High-output disabled	280						255
4	High-output enabled	245 (<210>)	215 (<210>)	185	160	140	30	
	High-output disabled	140						125

Values in brackets <> are for vertical use.

① Stroke

Stroke (mm)	Standard price	Stroke (mm)	Standard price
50	-	450	-
100	-	500	-
150	-	550	-
200	-	600	-
250	-	650	-
300	-	700	-
350	-	750	-
400	-	800	-

② Cable Length

Type	Cable code	Standard price	Type	Cable code	Standard price
Standard type	P (1m)	-	Robot cable	R01 (1m) ~R03 (3m)	-
	S (3m)	-		R04 (4m) ~R05 (5m)	-
	M (5m)	-		R06 (6m) ~R10 (10m)	-
Special length	X06 (6m) ~X10 (10m)	-		R11 (11m)~R15 (15m)	-
	X11 (11m)~X15 (15m)	-		R16 (16m)~R20 (20m)	-
	X16 (16m)~X20 (20m)	-			

*Please refer to P. 89 for maintenance cables.

③ Options

Name	Option code	Reference page	Standard price
Brake	B	→P. 11	-
Cable exit direction (Top)	CJT	→P. 11	-
Cable exit direction (Right)	CJR	→P. 11	-
Cable exit direction (Left)	CJL	→P. 11	-
Cable exit direction (Bottom)	CJB	→P. 11	-
Non-motor end specification	NM	→P. 11	-
Vacuum joint on opposite side	VR	→P. 11	-

Actuator Specifications

Item	Description
Drive system	Ball screw Ø12mm, rolled C10
Positioning repeatability (*1)	±0.02mm [±0.03mm]
Lost motion	0.1mm or less
Base	Material: Aluminum with white alumite treatment
Dynamic allowable moment (*2)	Ma: 11.6N·m, Mb: 16.6N·m, Mc: 33.7N·m
Static allowable moment	Ma: 51.2N·m, Mb: 73.1N·m, Mc: 148N·m
Cleanliness	Class 10 (0.1µm)
Ambient operating temperature, humidity	0 to 40°C, 85% RH or less (Non-condensing)

*Reference for overhang load length/Ma: 230mm or less, Mb, Mc: 230mm or less

(*1) The values in brackets [] are for Lead 24.

(*2) Assumes a standard rated life of 5,000km.

(*) The operational life will vary depending on operation and installation conditions. Please refer to the general catalog for details on operational life, allowable moment direction, and overhang load length.

Dimensions

CAD drawings can be downloaded from our website. www.intelligentactuator.com



- *1 When the slider is returning to its home position, please be careful of interference from surrounding objects, as it will travel until it reaches the ME.
- ME: Mechanical end
SE: Stroke end
- *2 There is no pipe joint for RCP5-SA7C Slider Roller Type (SR).

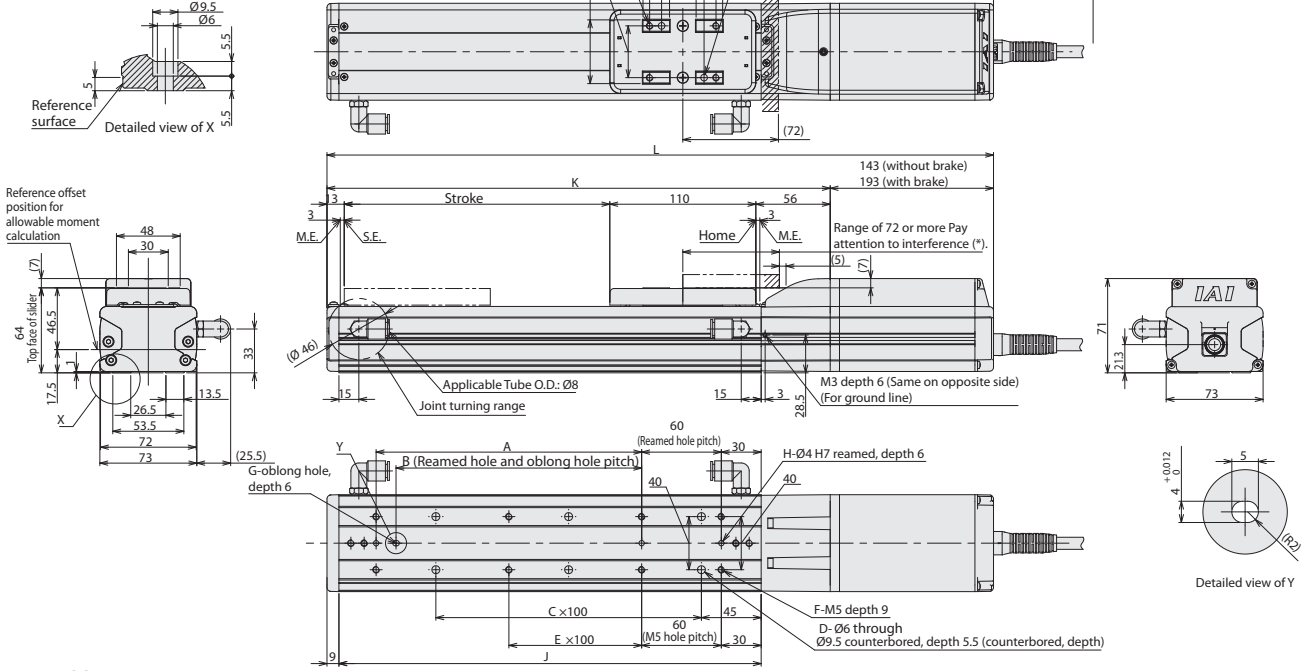

■ Cable Exit Direction (Option)

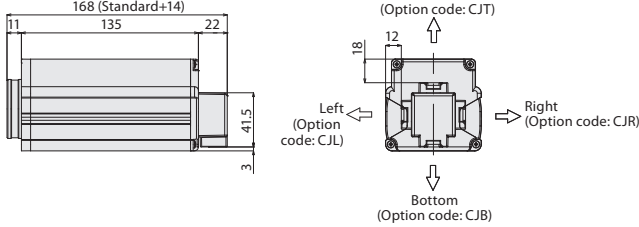

■ Dimensions and Mass by Stroke

L	Stroke	50	100	150	200	250	300	350	400	450	500	550	600	650	700	750	800
	Without brake	372	422	472	522	572	622	672	722	772	822	872	922	972	1,022	1,072	1,122
With brake	422	472	522	572	622	672	722	772	822	872	922	972	1,022	1,072	1,122	1,172	1,222
A	0	100	100	200	200	300	300	400	400	500	500	600	600	700	700	800	800
B	0	85	85	185	185	285	285	385	385	485	485	585	585	685	685	785	785
C	1	1	2	2	3	3	4	4	5	5	6	6	7	7	8	8	8
D	4	4	6	6	8	8	10	10	12	12	14	14	16	16	18	18	18
E	0	0	0	1	1	2	2	3	3	4	4	5	5	6	6	7	7
F	4	6	6	8	8	10	10	12	12	14	14	16	16	18	18	20	20
G	0	1	1	1	1	1	1	1	1	1	1	1	1	1	1	1	1
H	2	3	3	3	3	3	3	3	3	3	3	3	3	3	3	3	3
J	168	218	268	318	368	418	468	518	568	618	668	718	768	818	868	918	918
K	229	279	329	379	429	479	529	579	629	679	729	779	829	879	929	979	979
Mass (kg)	Without brake	3.0	3.2	3.5	3.7	3.9	4.1	4.4	4.6	4.8	5.0	5.3	5.5	5.7	5.9	6.1	6.4
	With brake	3.5	3.7	4.0	4.2	4.4	4.6	4.9	5.1	5.3	5.5	5.8	6.0	6.2	6.4	6.6	6.9

Applicable Controllers

The RCP5CR series actuators can be operated by the controllers indicated below. Please select the type depending on your intended use.

Name	External view	Model number	Max. number of controlled axes	Maximum number of positioning points	Input power	Standard price	Reference page
Positioner type (High-output specification)		PCON-CA-56PWAI-①-2-0	1	512 points	DC24V	-	→P.69
Pulse train type (High-output specification)		PCON-CA-56PWAI-PL②-2-0				-	
Network type (High-output specification)		PCON-CA-56PWAI-③-0-0				-	
Solenoid valve multi-axis type (PIO specification)		MSEP-④-⑤-⑥-⑦-⑧-2-0	4 (4 when high-output enabled) LC: 6 (3 when high-output enabled)	3 points	Single-phase AC 100V~230V	-	→P.77
Solenoid valve multi-axis type (Network specification)		MSEP-④-⑤-⑥-⑦-⑧-0-0				256 points	
Program control multi-axis type		MSEL-PC-1-56PWAI-①-2-4	4	30,000 points	Single-phase AC 100V~230V	-	→P.87
Program control multi-axis type (w/network board)		MSEL-PC-1-56PWAI-②-0-4				-	
Program control multi-axis type (Safety category compliant spec.)		MSEL-PG-1-56PWAI-①-2-4				-	
Program control multi-axis type (Safety category compliant spec. w/network board)		MSEL-PG-1-56PWAI-②-0-4				-	

*Above MSEL models are for single-axis specification
 *① I/O type (NP/PN)
 *② Field network specification code
 *③ Number of axes
 *④ N (NPN specification) or P (PNP specification) code
 *⑤ C or LC
 *⑥ N (NPN specification) or P (PNP specification) code
 *The high output enabled operation is only available when the "High-output setting specs" is selected in the MSEP-C/LC.

RCP5-BA4/BA4U ROBO Cylinder, Belt Type, Actuator Width 40mm, Pulse Motor, Top-mounted Motor/Bottom-mounted Motor

Model	RCP5	WA	35P	48	P3				
Specification	Series	Type	Encoder type	Motor type	Lead	Stroke	Applicable controllers	Cable length	Options
Items	BA4: Belt type Top-mounted motor BA4U: Belt type Bottom-mounted motor	WA: Battery-less absolute specification	35P: Pulse motor, size 35□	48: Equiv. to 48mm	300: 300mm 1200: 1,200mm (Every 100mm)	P3: PCON-CA MSEP MSEL	N: No cable P: 1m S: 3m M: 5m X□□: Specified length R□□: Robot cable	Please refer to the options table below.	

*Controller is not included.

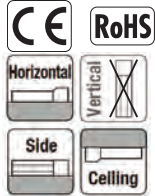

* Depending on the model, there may be some limitations to using the side and ceiling mount positions. Please refer to P.59 for details.

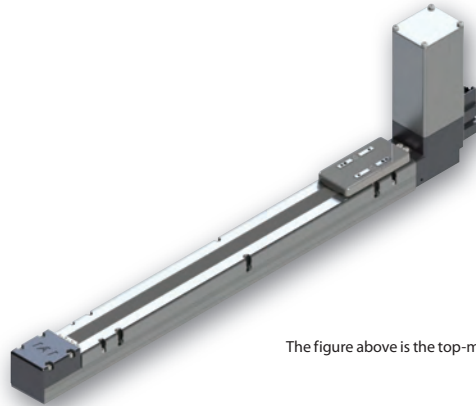

The figure above is the top-mounted motor type.

Correlation Diagram of Speed and Payload

Due to a pulse motor used for RCP5 series, its payload gets lower when operated at higher speed. Please refer to this diagram below to make sure that the required payload will be met at the operation speed you desire.

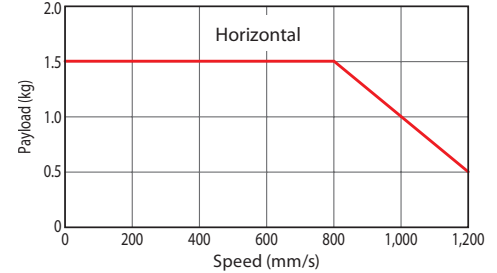

Warnings

- This model cannot be installed in the vertical mount position.
- Horizontal and ceiling mount specifications cannot be installed in the side position. Similarly, side mount specification cannot be installed in a horizontal or ceiling mount position.
- The maximum stroke for the side and ceiling mount positions is 1,000mm.

- POINT**
Note on selection
- Please set the operation speed at 150mm/s or higher for the belt type as it may cause vibration or noise when used at lower speed.
 - Due to a pulse motor used for RCP5 series, its payload gets lower when operated at higher speed. Please refer to the correlation diagram of speed and payload on this page to make sure that the required payload will be met at the operation speed you desire.
 - The payload assumes operation at an acceleration of 0.5G. 0.5G is the upper limit of the acceleration.
 - Push-motion operation cannot be performed.

Actuator Specifications

Lead and Payload

Model number	Motor attached side	Lead (mm)	Maximum payload		Stroke (mm)
			Horizontal (kg)		
RCP5-BA4-WA-35P-48-①-P3-②-③	Top	Equiv. to 48mm	1.5		300~1,200 (Every 100mm)
RCP5-BA4U-WA-35P-48-①-P3-②-③	Bottom				

Legend: ① Stroke ② Cable length ③ Options

Stroke and Maximum Speed

(Unit: mm/s)

Lead (mm)	300 (mm)	400 (mm)	500 (mm)	600 (mm)	700~1,200 (Every 100mm)
Equiv. to 48mm	890	1,040	1,120	1,160	1,200

① Stroke

Stroke (mm)	Standard price	Stroke (mm)	Standard price
300	-	800	-
400	-	900	-
500	-	1,000	-
600	-	1,100	-
700	-	1,200	-

② Cable Length

Type	Cable code	Standard price
Standard type	P (1m)	-
	S (3m)	-
	M (5m)	-
Special length	X06 (6m) ~X10 (10m)	-
	X11 (11m)~X15 (15m)	-
	X16 (16m)~X20 (20m)	-
	R01 (1m) ~R03 (3m)	-
Robot cable	R04 (4m) ~R05 (5m)	-
	R06 (6m) ~R10 (10m)	-
	R11 (11m)~R15 (15m)	-
	R16 (16m)~R20 (20m)	-

*Please refer to P. 89 for maintenance cables.

③ Options

Name	Option code	Reference page	Standard price
Brake	B	→P. 11	-
Cable exit direction (Top)	CJT	→P. 11	-
Cable exit direction (Right)	CJR	→P. 11	-
Cable exit direction (Left)	CJL	→P. 11	-
Cable exit direction (Bottom)	CJB	→P. 11	-
Ceiling mount type	CIM	→P. 59	-
Left side-mount type	SIL	→P. 59	-
Right side-mount type	SIR	→P. 59	-
Non-motor end specification	NM	→P. 11	-

Actuator Specifications

Item	Description
Drive system	Timing belt
Positioning repeatability	±0.08mm
Lost motion	0.1mm or less
Base	Material: Aluminum with white alumite treatment
Dynamic allowable moment (*1)	Ma: 6.14N·m, Mb: 6.14N·m, Mc: 11.9N·m
Static allowable moment	Ma: 16N·m, Mb: 16N·m, Mc: 31.2N·m
Ambient operating temperature, humidity	0 to 40°C, 85% RH or less (Non-condensing)

*Reference for overhang load length/Ma: 120mm or less, Mb, Mc: 120mm or less

(*1) Assumes a standard rated life of 5,000km.

(*2) The operational life will vary depending on operation and installation conditions. Please refer to the general catalog for details on operational life, allowable moment direction, and overhang load length.

Dimensions

CAD drawings can be downloaded from our website. www.intelligentactuator.com



*1 When the slider is returning to its home position, please be careful of interference from surrounding objects, as it will travel until it reaches the ME.
ME: Mechanical end
SE: Stroke end

*The way to attach the actuator is to fix with screws from the top only.

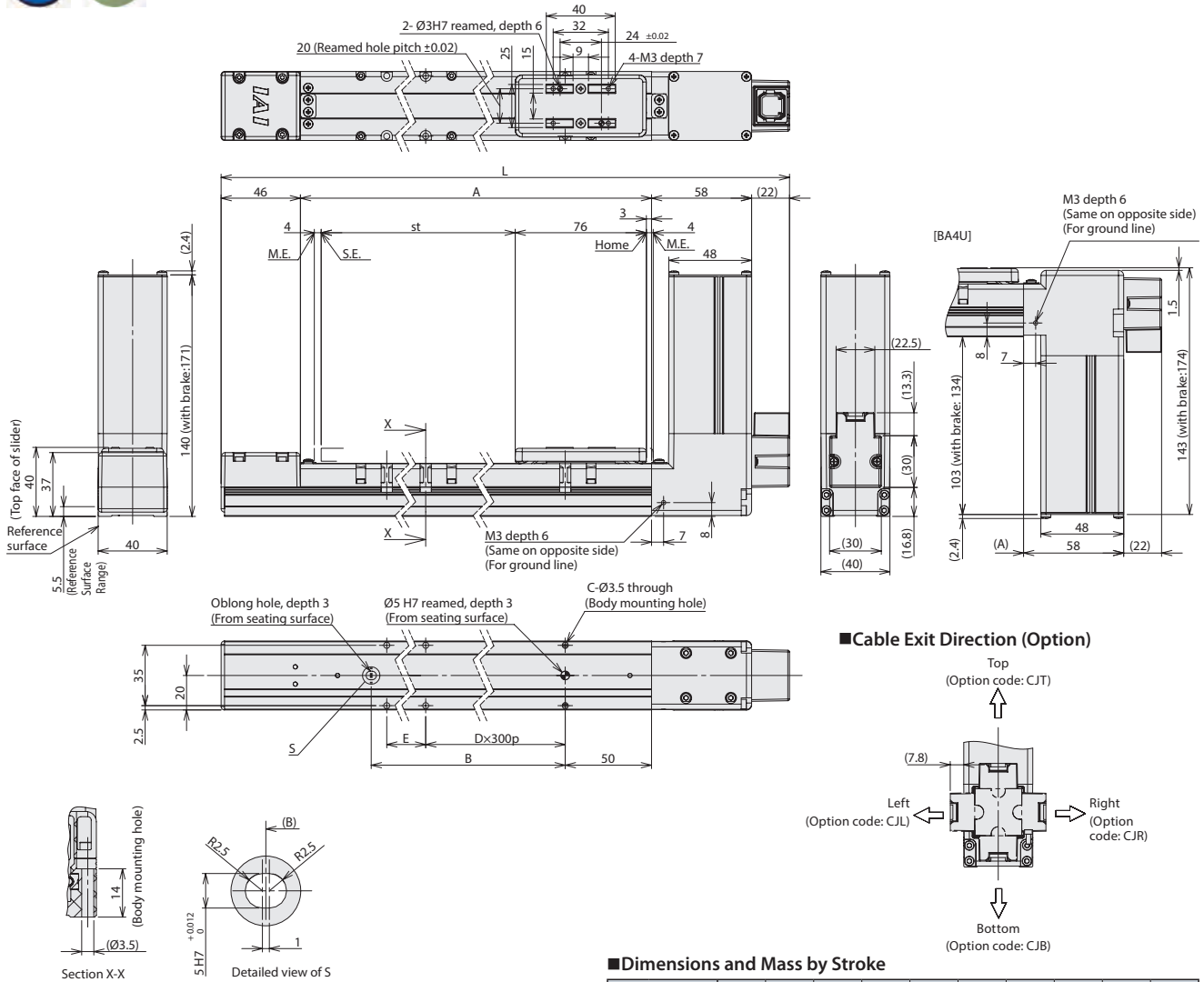

■ Cable Exit Direction (Option)

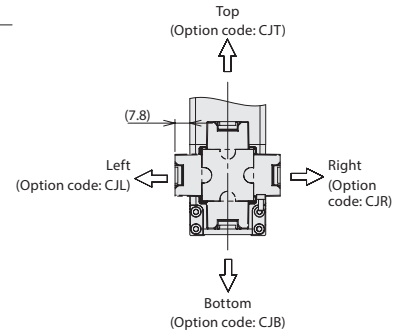

■ Dimensions and Mass by Stroke

Stroke	300	400	500	600	700	800	900	1,000	1,100	1,200	
L	517	617	717	817	917	1,017	1,117	1,217	1,317	1,417	
A	391	491	591	691	791	891	991	1,091	1,191	1,291	
B	300	400	500	600	700	800	900	1,000	1,100	1,200	
C	4	6	6	6	8	8	8	10	10	10	
D	0	1	1	1	2	2	2	3	3	3	
E	291	91	191	291	91	191	291	91	191	291	
Mass (kg)	Without brake	1.7	1.8	2	2.1	2.3	2.4	2.5	2.7	2.8	2.9
	With brake	1.9	2	2.2	2.3	2.5	2.6	2.7	2.9	3	3.1

*The weights shown in the table above are for BA4. The weight increases by 0.2kg for BA4U.

Applicable Controllers

The RCP5 series actuators can be operated by the controllers indicated below. Please select the type depending on your intended use.

Name	External view	Model number	Max. number of controlled axes	Maximum number of positioning points	Input power	Standard price	Reference page
Positioner type (High-output specification)		PCON-CA-35PWAI-①-2-0	1	512 points	DC24V	-	→P. 69
Pulse train type (High-output specification)		PCON-CA-35PWAI-PL②-2-0				-	
Network type (High-output specification)		PCON-CA-35PWAI-③-0-0				-	
Solenoid valve multi-axis type (PIO specification)		MSEP-④-①-①-①-2-0	C: 8 (4 when high-output enabled) LC: 6 (3 when high-output enabled)	3 points	Single-phase AC 100V~230V	-	→P. 77
Solenoid valve multi-axis type (Network specification)		MSEP-④-①-①-③-0-0				256 points	
Program control multi-axis type		MSEL-PC-1-35PWAI-①-2-4	4	30,000 points	Single-phase AC 100V~230V	-	→P. 87
Program control multi-axis type (w/network board)		MSEL-PC-1-35PWAI-④-0-4					
Program control multi-axis type (Safety category compliant spec.)		MSEL-PG-1-35PWAI-①-2-4					
Program control multi-axis type (Safety category compliant spec. w/network board)		MSEL-PG-1-35PWAI-④-0-4					

*Above MSEL models are for single-axis specification
 *① I/O type (NP/PN)
 *② Field network specification code
 *③ N (NPN specification) or P (PNP specification) code
 *④ Number of axes
 *⑤ C or LC
 *⑥ N (NPN specification) or P (PNP specification) code
 *The high output enabled operation is only available when the "High-output setting specs" is selected in the MSEP-C/LC.

RCP5-BA6/BA6U ROBO Cylinder, Belt Type, Actuator Width 58mm, Pulse Motor, Top-mounted Motor/Bottom-mounted Motor

Model	RCP5	WA	42P	48	P3				
Specification	Series	Type	Encoder type	Motor type	Lead	Stroke	Applicable controllers	Cable length	Options
Items		BA6: Belt type Top-mounted motor BA6U: Belt type Bottom-mounted motor	WA: Battery-less absolute specification	42P: Pulse motor, size 42□	48: Equiv. to 48mm	300: 300mm 2200: 2,200mm (Every 100mm)	P3: PCON-CA MSEP MSEL	N: No cable P: 1m S: 3m M: 5m X□□: Specified length R□□: Robot cable	Please refer to the options table below.

*Controller is not included.

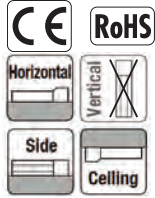

* Depending on the model, there may be some limitations to using the side and ceiling mount positions. Please refer to P.59 for details.

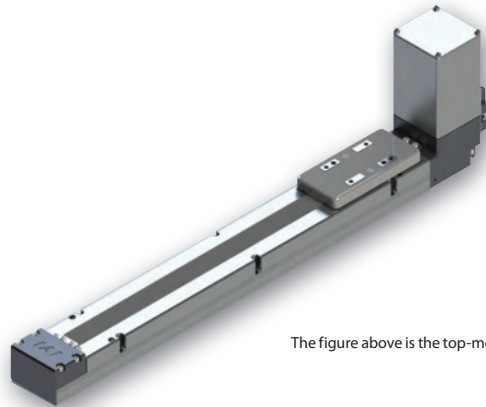

The figure above is the top-mounted motor type.

Correlation Diagram of Speed and Payload

Due to a pulse motor used for RCP5 series, its payload gets lower when operated at higher speed. Please refer to this diagram below to make sure that the required payload will be met at the operation speed you desire.

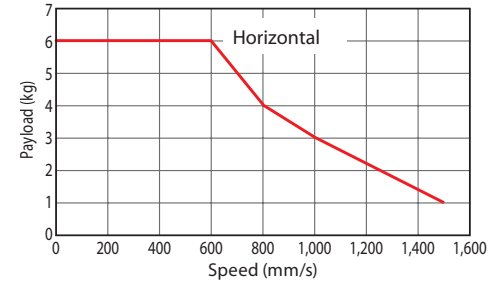

Warnings

- This model cannot be installed in the vertical mount position.
- Horizontal and ceiling mount specifications cannot be installed in the side position. Similarly, side mount specification cannot be installed in a horizontal or ceiling mount position.
- The maximum stroke for the side and ceiling mount positions is 1,000mm.

- POINT**
Note on selection
- (1) Please set the operation speed at 100mm/s or higher for the belt type as it may cause vibration or noise when used at lower speed.
 - (2) Due to a pulse motor used for RCP5 series, its payload gets lower when operated at higher speed. Please refer to the correlation diagram of speed and payload on this page to make sure that the required payload will be met at the operation speed you desire.
 - (3) The payload assumes operation at an acceleration of 0.5G. 0.5G is the upper limit of the acceleration.
 - (4) Push-motion operation cannot be performed.

Actuator Specifications

Lead and Payload

Model number	Motor attached side	Lead (mm)	Maximum payload		Stroke (mm)
			Horizontal (kg)		
RCP5-BA6-WA-42P-48-①-P3-②-③	Top	Equiv. to 48mm	6		300~2,200 (Every 100mm)
RCP5-BA6U-WA-42P-48-①-P3-②-③	Bottom				

Legend: ① Stroke ② Cable length ③ Options

Stroke and Maximum Speed

(Unit: mm/s)

Lead (mm)	300 (mm)	400 (mm)	500 (mm)	600 (mm)	700 (mm)	800 (mm)	900~2,200 (Every 100mm)
Equiv. to 48mm	890	1,070	1,220	1,340	1,400	1,440	1,500

① Stroke

Stroke (mm)	Standard price	Stroke (mm)	Standard price
300	-	1,300	-
400	-	1,400	-
500	-	1,500	-
600	-	1,600	-
700	-	1,700	-
800	-	1,800	-
900	-	1,900	-
1,000	-	2,000	-
1,100	-	2,100	-
1,200	-	2,200	-

② Cable Length

Type	Cable code	Standard price
Standard type	P (1m)	-
	S (3m)	-
	M (5m)	-
Special length	X06 (6m) ~X10 (10m)	-
	X11 (11m)~X15 (15m)	-
	X16 (16m)~X20 (20m)	-
	R01 (1m) ~R03 (3m)	-
Robot cable	R04 (4m) ~R05 (5m)	-
	R06 (6m) ~R10 (10m)	-
	R11 (11m)~R15 (15m)	-
	R16 (16m)~R20 (20m)	-

*Please refer to P. 89 for maintenance cables.

③ Options

Name	Option code	Reference page	Standard price
Brake	B	→P. 11	-
Cable exit direction (Top)	CJT	→P. 11	-
Cable exit direction (Right)	CJR	→P. 11	-
Cable exit direction (Left)	CJL	→P. 11	-
Cable exit direction (Bottom)	CJB	→P. 11	-
Ceiling mount type	CIM	→P. 59	-
Left side-mount type	SIL	→P. 59	-
Right side-mount type	SIR	→P. 59	-
Non-motor end specification	NM	→P. 11	-

Actuator Specifications

Item	Description
Drive system	Timing belt
Positioning repeatability	±0.08mm
Lost motion	0.1mm or less
Base	Material: Aluminum with white alumite treatment
Dynamic allowable moment (*1)	Ma: 15.7N·m, Mb: 15.7N·m, Mc: 31.6N·m
Static allowable moment	Ma: 44.5N·m, Mb: 44.5N·m, Mc: 89.2N·m
Ambient operating temperature, humidity	0 to 40°C, 85% RH or less (Non-condensing)

*Reference for overhang load length/Ma: 150mm or less, Mb, Mc: 150mm or less

(*1) Assumes a standard rated life of 5,000km.

(*2) The operational life will vary depending on operation and installation conditions. Please refer to the general catalog for details on operational life, allowable moment direction, and overhang load length.

Dimensions

CAD drawings can be downloaded from our website. www.intelligentactuator.com



*1 When the slider is returning to its home position, please be careful of interference from surrounding objects, as it will travel until it reaches the ME.
ME: Mechanical end
SE: Stroke end

*The way to attach the actuator is to fix with screws from the top only.

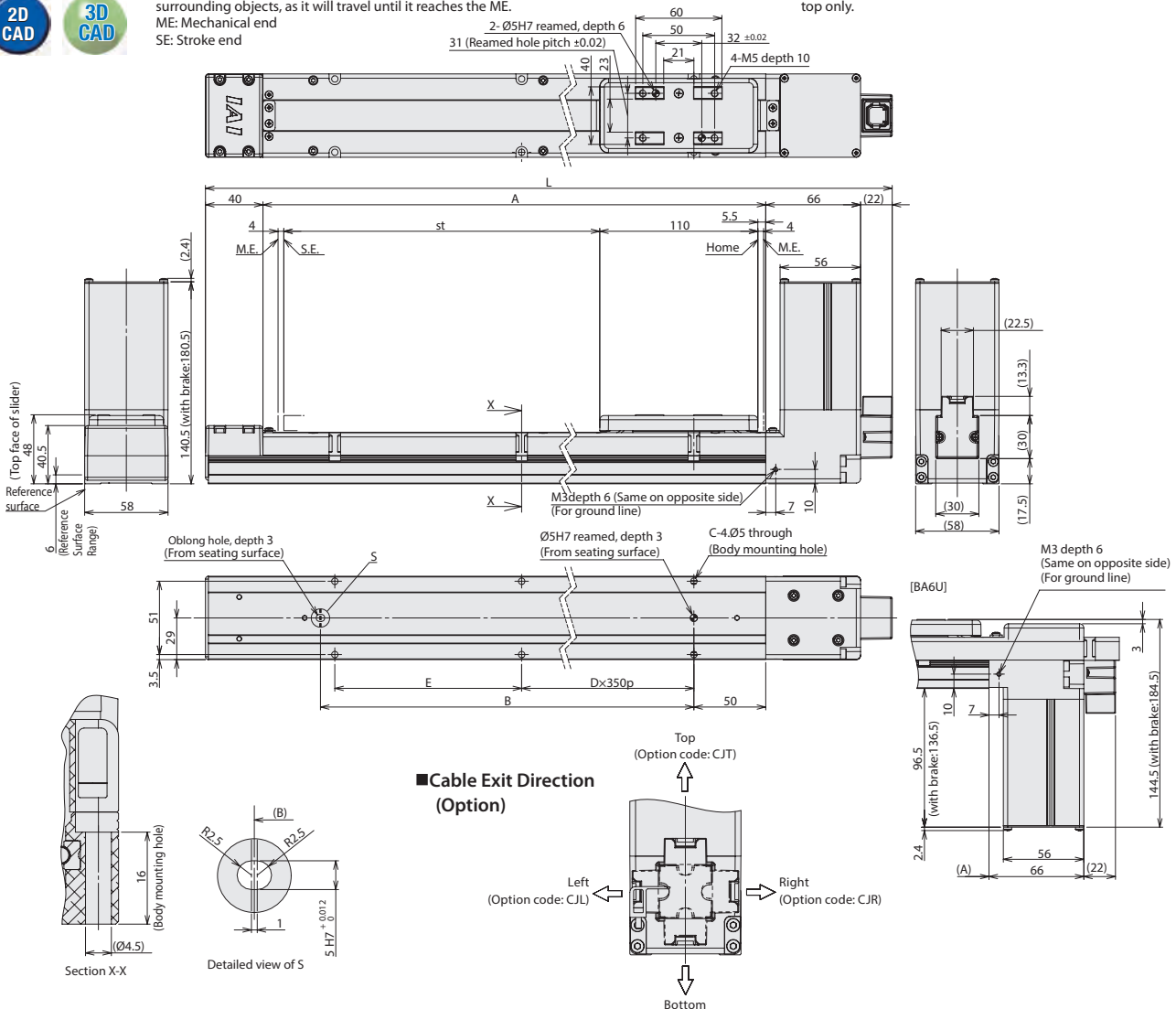

■ Dimensions and Mass by Stroke

Stroke	300	400	500	600	700	800	900	1,000	1,100	1,200	1,300	1,400	1,500	1,600	1,700	1,800	1,900	2,000	2,100	2,200	
L	558	658	758	858	958	1,058	1,158	1,258	1,358	1,458	1,558	1,658	1,758	1,858	1,958	2,058	2,158	2,258	2,358	2,458	
A	430	530	630	730	830	930	1,030	1,130	1,230	1,330	1,430	1,530	1,630	1,730	1,830	1,930	2,030	2,130	2,230	2,330	
B	340	440	540	640	740	840	940	1,040	1,140	1,240	1,340	1,440	1,540	1,640	1,740	1,840	1,940	2,040	2,140	2,240	
C	4	6	6	6	6	8	8	8	10	10	10	10	12	12	12	14	14	14	14	14	16
D	0	1	1	1	1	2	2	2	3	3	3	3	4	4	4	5	5	5	5	5	6
E	330	80	180	280	380	130	230	330	80	180	280	380	130	230	330	80	180	280	380	130	63
Mass (kg)	Without brake	2.2	2.4	2.7	2.9	3.1	3.3	3.5	3.7	3.9	4.2	4.4	4.6	4.8	5	5.2	5.4	5.6	5.9	6.1	6.3
	With brake	2.6	2.8	3.1	3.3	3.5	3.7	3.9	4.1	4.3	4.6	4.8	5	5.2	5.4	5.6	5.8	6	6.3	6.5	6.7

*The weights shown in the table above are for BA6. The weight increases by 0.2kg for BA6U.

Applicable Controllers

The RCP5 series actuators can be operated by the controllers indicated below. Please select the type depending on your intended use.

Name	External view	Model number	Max. number of controlled axes	Maximum number of positioning points	Input power	Standard price	Reference page
Positioner type (High-output specification)		PCON-CA-42PWAI-①-2-0	1	512 points	DC24V	-	→P.69
Pulse train type (High-output specification)		PCON-CA-42PWAI-PL②-2-0				-	
Network type (High-output specification)		PCON-CA-42PWAI-③-0-0				-	
Solenoid valve multi-axis type (PIO specification)		MSEP-④-⑤-⑥-⑦-⑧-2-0	C: 8 (4 when high-output enabled) LC: 6 (3 when high-output enabled)	3 points	Single-phase AC 100V~230V	-	→P.77
Solenoid valve multi-axis type (Network specification)		MSEP-④-⑤-⑥-⑦-⑧-0-0				256 points	
Program control multi-axis type		MSEL-PC-1-42PWAI-①-2-4	4	30,000 points	Single-phase AC 100V~230V	-	→P.87
Program control multi-axis type (w/network board)		MSEL-PC-1-42PWAI-②-0-4				-	
Program control multi-axis type (Safety category compliant spec.)		MSEL-PG-1-42PWAI-③-2-4				-	
Program control multi-axis type (Safety category compliant spec. w/network board)		MSEL-PG-1-42PWAI-④-0-4				-	

*Above MSEL models are for single-axis specification *① I/O type (NP/PN) *② Number of axes
 *③ Field network specification code *④ C or LC *⑤ N (NPN specification) or P (PNP specification) code
 *The high output enabled operation is only available when the "High-output setting specs" is selected in the MSEP-C/LC.

RCP5-BA7/BA7U ROBO Cylinder, Belt Type, Actuator Width 70mm, Pulse Motor, Top-mounted Motor/Bottom-mounted Motor

Model	RCP5	WA	56P	48	P3				
Specification	Series	Type	Encoder type	Motor type	Lead	Stroke	Applicable controllers	Cable length	Options
Items		BA7: Belt type Top-mounted motor BA7U: Belt type Bottom-mounted motor	WA: Battery-less absolute specification	56P: Pulse motor, size 56□ 48: Equiv. to 48mm		300: 300mm 2600: 2,600mm (Every 100mm)	P3: PCON-CA MSEP MSEL	N: No cable P: 1m S: 3m M: 5m X□□: Specified length R□□: Robot cable	Please refer to the options table below.

*Controller is not included.

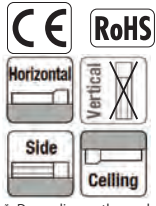

* Depending on the model, there may be some limitations to using the side and ceiling mount positions. Please refer to P.59 for details.

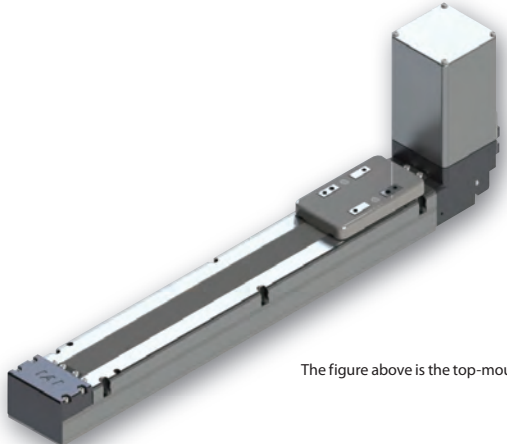

The figure above is the top-mounted motor type.

Correlation Diagram of Speed and Payload
Due to a pulse motor used for RCP5 series, its payload gets lower when operated at higher speed. Please refer to this diagram below to make sure that the required payload will be met at the operation speed you desire.

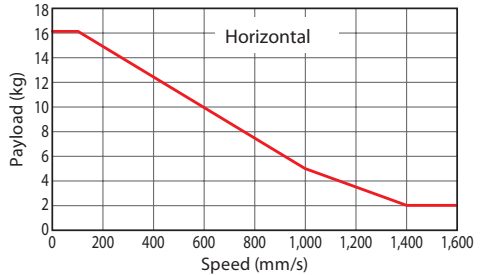

Warnings

- This model cannot be installed in the vertical mount position.
- Horizontal and ceiling mount specifications cannot be installed in the side position. Similarly, side mount specification cannot be installed in a horizontal or ceiling mount position.
- The maximum stroke for the side and ceiling mount positions is 1,000mm.

- POINT**
Note on selection
- (1) Please set the operation speed at 100mm/s or higher for the belt type as it may cause vibration or noise when used at lower speed.
 - (2) Due to a pulse motor used for RCP5 series, its payload gets lower when operated at higher speed. Please refer to the correlation diagram of speed and payload on this page to make sure that the required payload will be met at the operation speed you desire.
 - (3) The payload assumes operation at an acceleration of 0.5G. 0.5G is the upper limit of the acceleration.
 - (4) Push-motion operation cannot be performed.

Actuator Specifications

Model number	Motor attached side	Lead (mm)	Maximum payload		Stroke (mm)	Stroke and Maximum Speed (Unit: mm/s)									
			Horizontal (kg)			Lead (mm)	300 (mm)	400 (mm)	500 (mm)	600 (mm)	700 (mm)	800 (mm)	900 (mm)	1,000~2,600 (Every 100mm)	
RCP5-BA7-WA-56P-48-①-P3-②-③	Top	Equiv. to 48mm	16		300~2,600 (Every 100mm)	Equiv. to 48mm	890	1,070	1,220	1,340	1,450	1,520	1,550	1,600	
RCP5-BA7U-WA-56P-48-①-P3-②-③	Bottom														

Legend: ① Stroke ② Cable length ③ Options

① Stroke

Stroke (mm)	Standard price	Stroke (mm)	Standard price
300	-	1,500	-
400	-	1,600	-
500	-	1,700	-
600	-	1,800	-
700	-	1,900	-
800	-	2,000	-
900	-	2,100	-
1,000	-	2,200	-
1,100	-	2,300	-
1,200	-	2,400	-
1,300	-	2,500	-
1,400	-	2,600	-

② Cable Length

Type	Cable code	Standard price
Standard type	P (1m)	-
	S (3m)	-
	M (5m)	-
Special length	X06 (6m) ~X10 (10m)	-
	X11 (11m)~X15 (15m)	-
	X16 (16m)~X20 (20m)	-
	R01 (1m) ~R03 (3m)	-
Robot cable	R04 (4m) ~R05 (5m)	-
	R06 (6m) ~R10 (10m)	-
	R11 (11m)~R15 (15m)	-
	R16 (16m)~R20 (20m)	-

*Please refer to P. 89 for maintenance cables.

③ Options

Name	Option code	Reference page	Standard price
Brake	B	→P. 11	-
Cable exit direction (Top)	CJT	→P. 11	-
Cable exit direction (Right)	CJR	→P. 11	-
Cable exit direction (Left)	CJL	→P. 11	-
Cable exit direction (Bottom)	CJB	→P. 11	-
Ceiling mount type	CIM	→P. 59	-
Left side-mount type	SIL	→P. 59	-
Right side-mount type	SIR	→P. 59	-
Non-motor end specification	NM	→P. 11	-

Actuator Specifications

Item	Description
Drive system	Timing belt
Positioning repeatability	±0.08mm
Lost motion	0.1mm or less
Base	Material: Aluminum with white alumite treatment
Dynamic allowable moment (*1)	Ma: 33.2N·m, Mb: 33.2N·m, Mc: 72.3N·m
Static allowable moment	Ma: 80.7N·m, Mb: 80.7N·m, Mc: 175N·m
Ambient operating temperature, humidity	0 to 40°C, 85% RH or less (Non-condensing)

*Reference for overhang load length/Ma: 180mm or less, Mb, Mc: 180mm or less
(*1) Assumes a standard rated life of 5,000km.
(*2) The operational life will vary depending on operation and installation conditions. Please refer to the general catalog for details on operational life, allowable moment direction, and overhang load length.

Dimensions

CAD drawings can be downloaded from our website. www.intelligentactuator.com



*1 When the slider is returning to its home position, please be careful of interference from surrounding objects, as it will travel until it reaches the ME.

ME: Mechanical end
SE: Stroke end

*The way to attach the actuator is to fix with screws from the top only.

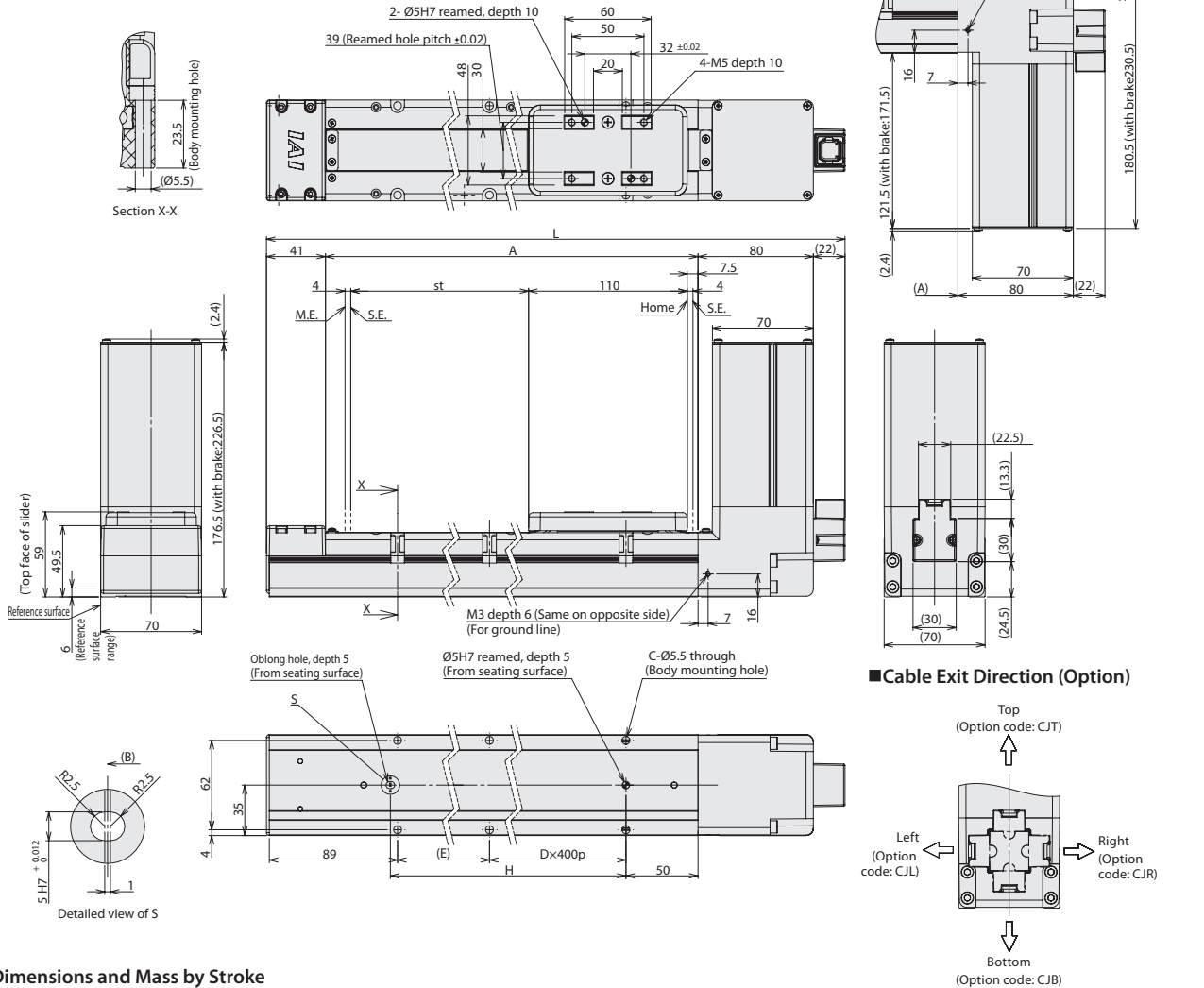

Dimensions and Mass by Stroke

Stroke	300	400	500	600	700	800	900	1,000	1,100	1,200	1,300	1,400	1,500	1,600	1,700	1,800	1,900	2,000	2,100	2,200	2,300	2,400	2,500	2,600	
L	578	678	778	878	978	1,078	1,178	1,278	1,378	1,478	1,578	1,678	1,778	1,878	1,978	2,078	2,178	2,278	2,378	2,478	2,578	2,678	2,778	2,878	
A	435	535	635	735	835	935	1,035	1,135	1,235	1,335	1,435	1,535	1,635	1,735	1,835	1,935	2,035	2,135	2,235	2,335	2,435	2,535	2,635	2,735	
B	340	440	540	640	740	840	940	1,040	1,140	1,240	1,340	1,440	1,540	1,640	1,740	1,840	1,940	2,040	2,140	2,240	2,340	2,440	2,540	2,640	
C	4	4	6	6	6	6	8	8	8	8	10	10	10	10	12	12	12	12	14	14	14	14	16	16	
D	0	0	1	1	1	1	2	2	2	2	3	3	3	3	4	4	4	4	5	5	5	5	6	6	
E	335	435	535	635	735	835	935	1,035	1,135	1,235	1,335	1,435	1,535	1,635	1,735	1,835	1,935	2,035	2,135	2,235	2,335	2,435	2,535	2,635	
Mass (kg)	Without brake	3.8	4.1	4.4	4.8	5.1	5.4	5.8	6.1	6.5	6.8	7.1	7.5	7.8	8.1	8.5	8.8	9.1	9.5	9.8	10.2	10.5	10.8	11.2	11.5
	With brake	4.4	4.7	5	5.4	5.7	6	6.4	6.7	7.1	7.4	7.7	8.1	8.4	8.7	9.1	9.4	9.7	10.1	10.4	10.8	11.1	11.4	11.8	12.1

*The weights shown in the table above are for BA7. The weight increases by 0.2kg for BA7U.

Applicable Controllers

The RCP5 series actuators can be operated by the controllers indicated below. Please select the type depending on your intended use.

Name	External view	Model number	Max. number of controlled axes	Maximum number of positioning points	Input power	Standard price	Reference page
Positioner type (High-output specification)		PCON-CA-56PWAI-①-2-0	1	512 points	DC24V	-	→P. 69
Pulse train type (High-output specification)		PCON-CA-56PWAI-PL②-2-0				-	
Network type (High-output specification)		PCON-CA-56PWAI-③-0-0				-	
Solenoid valve multi-axis type (PIO specification)		MSEL-④-⑤-⑥-⑦-⑧-2-0	4 (when high-output enabled) LC: 6 (3 when high-output enabled)	3 points	Single-phase AC 100V~230V	-	→P. 77
Solenoid valve multi-axis type (Network specification)		MSEL-④-⑤-⑥-⑦-⑧-0-0				256 points	
Program control multi-axis type		MSEL-PC-1-56PWAI-①-2-4	4	30,000 points	Single-phase AC 100V~230V	-	→P. 87
Program control multi-axis type (w/network board)		MSEL-PC-1-56PWAI-②-0-4				-	
Program control multi-axis type (Safety category compliant spec.)		MSEL-PG-1-56PWAI-③-2-4				-	
Program control multi-axis type (Safety category compliant spec. w/network board)		MSEL-PG-1-56PWAI-④-0-4				-	

*Above MSEL models are for single-axis specification
 *① I/O type (NP/PN)
 *② Field network specification code
 *③ Number of axes
 *④ C or LC
 *⑤ N (NPN specification) or P (PNP specification) code
 *The high output enabled operation is only available when the "High-output setting specs" is selected in the MSEL-C/LC.

Warnings When Installing the Rod Actuators

When installing the front bracket or flange (optional), please be careful that the actuator does not experience any external force. (External force may cause malfunctions or damaged parts)
If the actuator will experience external force or is being used in conjunction with a Cartesian robot, etc, please use the mounting holes on the base of the actuator to secure it into place.

Even in cases when external force will not be applied, to secure the actuator in place when installed horizontally using a flange or side-mounted motor specification, please use the bracket mounting holes to create a support base as shown in the diagram on the right.

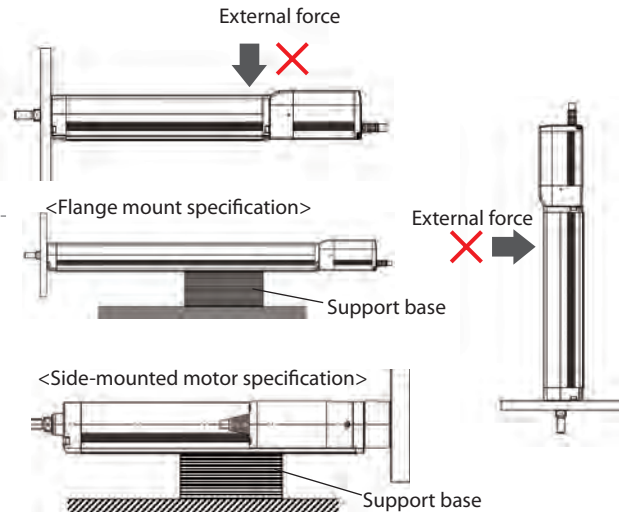

About the Mounting Positions

- While installation in the side and ceiling mount positions are available, this may cause slack or misalignment in the stainless steel sheet.
Continuing to use it this way could cause the stainless steel sheet to break. Please inspect it daily and adjust the sheet if any slack or misalignment is found.
- When installing the motor straight-type vertically, please set the motor on the top if possible.
While installing the motor on the bottom will not cause problems in normal operation, long periods of no activity may cause the grease to separate, flow into the motor unit, and cause problems in rare occasions.

Belt Type Mounting Positions

Horizontal and ceiling mount specifications cannot be installed in the side position. Similarly, side mount specification cannot be installed in a horizontal or ceiling mount position.
Tilted or vertical mount installations will cause operational failure, so please do not install it in these positions.
The maximum stroke for the side and ceiling mount positions is 1,000mm.
Please do not attempt to use a product with a stroke of more than 1,000mm in the side or ceiling mount positions.

Selection Guideline (Correlation Diagram of Push Force and Current-limiting Value)

In the push operation, the push force can be changed by changing the current force of the controller to be between 20%-70% (for SA4□ and RA4□, start from 30%). The maximum push force will vary depending on the model, so please refer to the graphs on the following pages and select one based on the needed push force for your intended use.

When using the push operation with the slider actuator, please limit the push current in order that the reactive moment caused by the push force does not exceed the dynamic allowable moment (M_a , M_b) specified in the catalog. Please refer to the figure on the right which shows the guide moment's active positions for help with calculating the moment. This can be done by considering the offset of the push force application position. Please note that if excessive force which exceeds the dynamic allowable moment is applied, it may damage the guide and shorten its operational life. Please keep this in mind and select a push current that is safely within its limits.

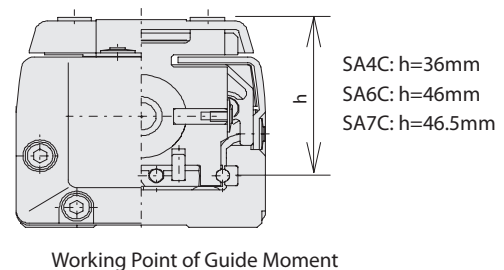

Calculation example:

If push-motion operation is performed with an RCP5-SA7C by applying 50N at the position shown to the right, the moment received by the guide, or

$$M_a \text{ is calculated as } (46.5 + 50) \times 50 = 4825 \text{ (N}\cdot\text{mm)} \\ = 4.825 \text{ (N}\cdot\text{m)}.$$

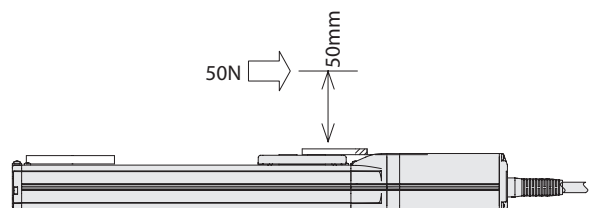

Since the dynamic allowable moment of the SA7C is $M_a=10 \text{ (N}\cdot\text{m)}$, since $10 \times 0.8 = 8 > 4.825$, this is an acceptable selection. Also, should an M_b moment occur due to the push operation, calculate the moment from the overhang and ensure that it is within range of the dynamic allowable moment.

Correlation Diagrams of Push Force and Current Limit

The graphs below are only a reference, and the graphs may vary slightly from the actual

SA4C/SA4R/RA4C/RA4R type

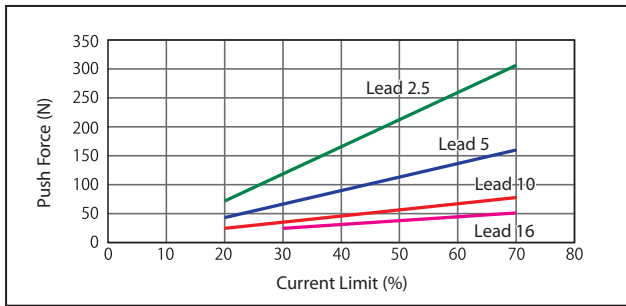

SA6C/SA6R/RA6C/RA6R type

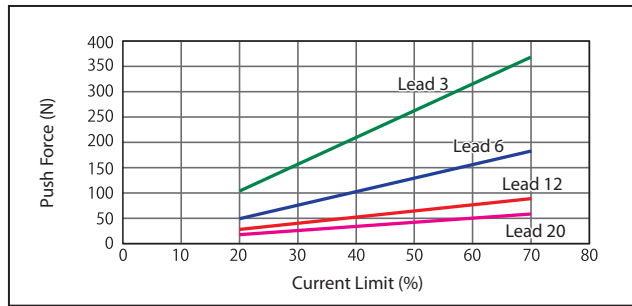

SA7C/SA7R type

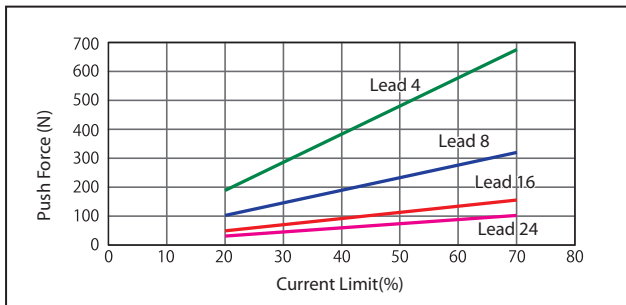

RA7C/RA7R type

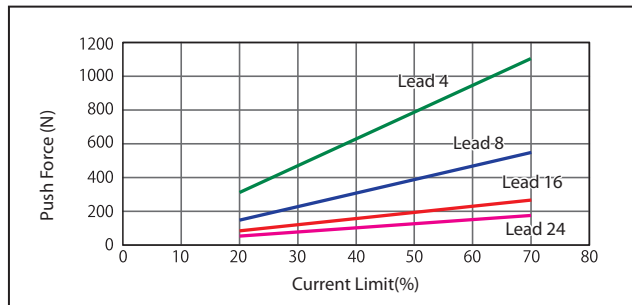

RA8C/RA8R type

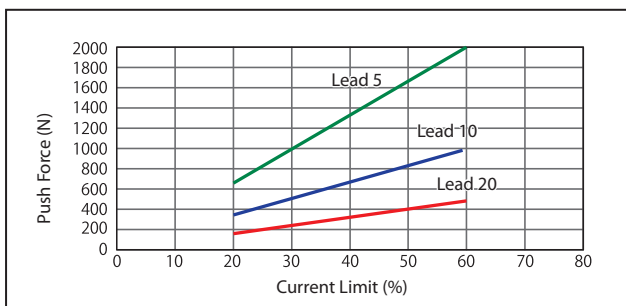

RA10C/RA10R type

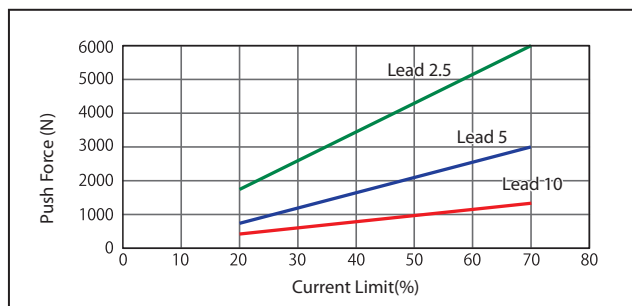

Warnings

- The correlation between push force and current limit are strictly for reference purposes. Actual numbers may vary slightly.
- A current limit of less than 20% will cause the push force to vary, so please use a limit of higher than 20%.
- Using the push operation, these graphs assume a traveling speed of 10mm/s for the RA8C/RA8R/RA10C/RA10R models and a 20mm/s speed for all other models.
- Using the RA8C/RA8R models at a current limit of greater than 70% can cause the motor to burn out, so please use a limit of 60% or less.
- Please refer to the table below when determining the upper limit of push cycles when the RCP5-RA10C/RA10R models are operated at the maximum push force and a push travel distance of 1mm.

Lead (type)	2.5	5	10
Push cycles	1.4 million cycles	25 million cycles	157.6 million cycles

* The upper limit of push cycles varies depending on the impact, vibration and other operating conditions. The cycles shown to the left assume no impact or vibration.

Warnings for RCP5-RA10C/RA10R Models Using the Push Operation

The push force is limited on certain RA10C/RA10R models due to its relationship with the buckling load of the ball screw. (Refer to the table below.)

(N)

Items	Stroke 550mm or less	Stroke 600mm or less	Stroke 650mm or less	Stroke 700mm or less	Stroke 750mm or less	Stroke 800mm or less
Lead 10	As shown in the push force graph					
Lead 5	As shown in the graph	2,900	2,500	2,200	2,000	1,800
Lead 2.5	As shown in the graph				5,900	5,400

Selection Guideline (Tables of RCP5 Payload by Speed/Acceleration)

When operating the RCP5, increasing the speed/acceleration reduces the travel time, but it also causes the payload to drop. The tables below provide the maximum payload in each acceleration/deceleration for different models. Find a model that satisfies the operational conditions you desire.

High-output enabled operation is only available if "high-output setting" is selected for the MSEP-C/CL controller.

High-output Setting Enabled

RCP5 Series Slider Type Motor Coupled Specification *The same tables apply when the RCP5CR is used.

RCP5-SA4C Lead 16

Orientation	Horizontal		Vertical					
	Acceleration (G)							
Speed (mm/s)	0.1	0.3	0.5	0.7	1	0.1	0.3	0.5
0	4	4	4	4	4	1	1	1
140	4	4	4	4	4	1	1	1
280	4	4	4	4	4	1	1	1
420	4	4	4	4	4	1	1	1
560	4	4	4	4	4	1	1	1
700	4	4	4	4	4	1	1	1
840	4	4	4	3.5	3	1	1	1
980	4	4	3.5	3		1	1	
1120	4	3	2	1.5	1			0.75
1260			2	1.5	1			0.5

RCP5-SA4C Lead 10

Orientation	Horizontal		Vertical					
	Acceleration (G)							
Speed (mm/s)	0.1	0.3	0.5	0.7	1	0.1	0.3	0.5
0	10	10	10	8	8	2.25	2.25	2.25
85	10	10	10	8	8	2.25	2.25	2.25
175	10	10	10	8	8	2.25	2.25	2.25
260	9	9	9	8	8	2.25	2.25	2.25
350	9	9	9	8	8	2.25	2.25	2.25
435	8	8	8	8	8	2.25	2.25	2.25
525	8	8	8	7	7	2.25	2.25	2.25
610	8	8	7	6	5	2.25	2.25	2.25
700			8	6	4	3	2	2
785			7	4	3	3	2	1.5

RCP5-SA4C Lead 5

Orientation	Horizontal		Vertical					
	Acceleration (G)							
Speed (mm/s)	0.1	0.3	0.5	0.7	1	0.1	0.3	0.5
0	12	12	12	10	10	4.5	4.5	4.5
40	12	12	12	10	10	4.5	4.5	4.5
85	12	12	12	10	10	4.5	4.5	4.5
130	11	11	11	10	10	4.5	4.5	4.5
175	10	10	10	10	10	4.5	4.5	4.5
215	10	10	10	10	10	4.5	4.5	4.5
260	10	10	10	10	10	4.5	4.5	4.5
305	10	10	10	10	10	4.5	4.5	4.5
350	10	10	10	10	10	4.5	4.5	4.5
390	10	10	10	10	10	4.5	4.5	4.5

RCP5-SA4C Lead 2.5

Orientation	Horizontal		Vertical					
	Acceleration (G)							
Speed (mm/s)	0.1	0.3	0.5	0.7	1	0.1	0.3	0.5
0	12	12	12	12	12	9	9	9
20	12	12	12	12	12	9	9	9
40	12	12	12	12	12	9	9	9
65	12	12	12	12	12	9	9	9
85	12	12	12	12	12	9	9	9
105	12	12	12	12	12	9	9	9
130	12	12	12	12	12	9	9	9
150	12	12	12	12	12	9	9	9
175	12	12	12	12	12	9	9	9
195	12	12	12	12	12	9	9	9

RCP5-SA6C Lead 20

Orientation	Horizontal		Vertical					
	Acceleration (G)							
Speed (mm/s)	0.1	0.3	0.5	0.7	1	0.1	0.3	0.5
0	10	10	9	7	6	1	1	1
160	10	10	9	7	6	1	1	1
320	10	10	9	7	6	1	1	1
480	10	10	9	7	6	1	1	1
640	10	10	8	6	5	1	1	1
800	10	9	6.5	4.5	3	1	1	1
960		8	5	3.5	2		1	1
1120		6.5	3	2	1.5		0.5	0.5
1280		1	1	1				0.5
1440			1	0.5				

RCP5-SA6C Lead 12

Orientation	Horizontal		Vertical					
	Acceleration (G)							
Speed (mm/s)	0.1	0.3	0.5	0.7	1	0.1	0.3	0.5
0	15	15	12.5	11	10	2.5	2.5	2.5
100	15	15	12.5	11	10	2.5	2.5	2.5
200	15	15	12.5	11	10	2.5	2.5	2.5
300	15	15	12.5	11	10	2.5	2.5	2.5
400	15	14	11	10	8.5	2.5	2.5	
500	15	13	10	8	6.5	2.5	2.5	
600	15	12	9	6	4	2.5	2.5	
700	12	10	8	4	2.5	2.5	2	
800	10	7	5	2	1	2	1.5	
900		5	3	1	1	0.5	0.5	

RCP5-SA6C Lead 6

Orientation	Horizontal		Vertical					
	Acceleration (G)							
Speed (mm/s)	0.1	0.3	0.5	0.7	1	0.1	0.3	0.5
0	25	25	20	16	14	6	6	6
50	25	25	20	16	14	6	6	6
100	25	25	20	16	14	6	6	6
150	25	25	20	16	14	6	6	6
200	25	25	20	16	14	6	6	6
250	25	25	20	16	14	6	6	6
300	25	25	20	15	11	6	5.5	5
350	25	20	14	12	9	6	4.5	
400	25	16	10	8	6.5	4.5	3.5	
450	18	12	6	5	2.5	3.5	2	

RCP5-SA6C Lead 3

Orientation	Horizontal		Vertical					
	Acceleration (G)							
Speed (mm/s)	0.1	0.3	0.5	0.7	1	0.1	0.3	0.5
0	25	25	25	25	25	16	16	16
25	25	25	25	25	25	16	16	16
50	25	25	25	25	25	16	16	16
75	25	25	25	25	25	16	16	16
100	25	25	25	25	25	16	16	16
125	25	25	25	25	25	16	16	16
150	25	25	25	25	22.5	16	14	13
175	25	25	25	20	19	13	12	11
200	25	25	20	18	16	11	10	9
225	25	18	16	15	12	9	8	

RCP5-SA7C Lead 24

Orientation	Horizontal		Vertical					
	Acceleration (G)							
Speed (mm/s)	0.1	0.3	0.5	0.7	1	0.1	0.3	0.5
0	20	20	18	16	14	3	3	3
200	20	20	18	16	14	3	3	3
400	20	20	18	16	14	3	3	3
600	20	18	15	10	9	3	3	3
800	16	12	10	7	4	3	3	2.5
1000	8	4.5	4	2		2	1.5	
1200		5.5	2	2	1		1	1

RCP5-SA7C Lead 16

Orientation	Horizontal		Vertical					
	Acceleration (G)							
Speed (mm/s)	0.1	0.3	0.5	0.7	1	0.1	0.3	0.5
0	40	40	35	28	27	8	8	8
140	40	40	35	28	27	8	8	8
280	40	38	35	25	24	8	8	8
420	35	25	20	15	10	6	5	4.5
560	25	20	15	10	6	5	4	
700	20	15	10	5	3	4	3	
840		9	4	2	2		1	
980			4					

RCP5-SA7C Lead 8

Orientation	Horizontal		Vertical					
	Acceleration (G)							
Speed (mm/s)	0.1	0.3	0.5	0.7	1	0.1	0.3	0.5
0	45	45	45	40	40	16	16	16
70	45	45	45	40	40	16	16	16
140	45	45	40	38	35	16	16	16
210	45	40	35	30	24	11	10	9.5
280	40	30	25	20	15	9	8	7
350	35	20	9	4		7	5	4
420		25	7			5	2	
490							2	

RCP5-SA7C Lead 4

Orientation	Horizontal		Vertical					
	Acceleration (G)							
Speed (mm/s)	0.1	0.3	0.5	0.7	1	0.1	0.3	0.5
0	45	45	45	40	40	25	25	25
35	45	45	45	40	40	25	25	25
70	45	45	45	40	40	25	25	25
105	45	45	45	40	35	22	20	19
140	45	45	35	30	25	16	14	12
175	45	30	18			11	9	7.5
210		40	8				8	
245								

RCP5 Series Rod Type Motor Coupled Specification

RCP5-RA4C Lead 16

Orientation	Horizontal		Vertical					
	Acceleration (G)							
Speed (mm/s)	0.1	0.3	0.5	0.7	1	0.1	0.3	0.5
0	6	6	6	5	3.5	1.5	1.5	1.5
140	6	6	6	5	3.5	1.5	1.5	1.5
280	6	6	6	5	3.5	1.5	1.5	1.5
420	6	6	6	5	3.5	1	1	1
560	6	6	5	3.5	1	1	1	
700		5.5	5	4	2.5	1	1	1
840		4.5	3.5	3	2		1	1
980			2.5	2	1.5		1	1
1120				2	1.5			0.75

RCP5-RA4C Lead 10

Orientation	Horizontal		Vertical					
	Acceleration (G)							
Speed (mm/s)	0.1	0.3	0.5	0.7	1	0.1	0.3	0.5
0	15	15	13	13	12	2.5	2.5	2.5
85	15	15	13	13	12	2.5	2.5	2.5
175	15	15	13	13	12	2.5	2.5	

High-output Setting Disabled

RCP5 Series

Slider Type Motor Coupled Specification *The same tables apply when the RCP5CR is used.

RCP5-SA4C Lead 16

Orientation	Horizontal		Vertical				
	Acceleration (G)						
Speed (mm/s)	0.2	0.3	0.5	0.7	0.1	0.2	0.5
0	4	4	4	3.5	1	1	1
140	4	4	4	3.5	1	1	1
280	4	4	4	3.5	1	1	1
420	4	4	3.5	3	1	1	0.75
560	4	3.5	3	2.5	1	0.75	0.75
700	3.5	3	2.5	2	0.75	0.75	0.5
840	2.5	2	1.5	1	0.5	0.5	

RCP5-SA4C Lead 10

Orientation	Horizontal		Vertical				
	Acceleration (G)						
Speed (mm/s)	0.2	0.3	0.5	0.7	0.1	0.2	0.3
0	10	10	9	8	2.25	2.25	2.25
85	10	10	9	8	2.25	2.25	2.25
175	10	10	9	8	2.25	2.25	2.25
260	9	9	8	6	2	2	2
350	8	7	6	5	2	2	2
435	7	6	5	4	2	1.5	1.5
525	6	5	4	3	1.5	1	1

RCP5-SA4C Lead 5

Orientation	Horizontal		Vertical				
	Acceleration (G)						
Speed (mm/s)	0.2	0.3	0.5	0.7	0.1	0.2	0.3
0	12	12	12	10	4.5	4.5	4.5
40	12	12	12	10	4.5	4.5	4.5
85	12	12	12	10	4.5	4.5	4.5
130	10	10	10	9	4	4	4
175	10	10	9	8	4	4	4
215	10	9	8	7	4	4	4
260	9	8	7	6	3.5	3	2.5

RCP5-SA4C Lead 2.5

Orientation	Horizontal		Vertical				
	Acceleration (G)						
Speed (mm/s)	0.2	0.3	0.5	0.7	0.1	0.2	0.3
0	12	12	12	12	9	9	9
20	12	12	12	12	9	9	9
40	12	12	12	12	9	9	9
65	12	12	11	11	8	8	8
85	12	11	10	10	8	8	8
105	12	10	10	9	8	8	8
130	12	10	9	8	5	5	5

RCP5-SA6C Lead 20

Orientation	Horizontal		Vertical			
	Acceleration (G)					
Speed (mm/s)	0.2	0.3	0.5	0.7	0.1	0.2
0	6	6	4	4	0.5	0.5
160	6	6	4	4	0.5	0.5
320	6	6	4	4	0.5	0.5
480	5	5	3	3	0.5	0.5
640	4	4	2	2	0.5	0.5
800	3	3	1	1	0.5	0.5
960	2	2	1	0.5	0.5	

RCP5-SA6C Lead 12

Orientation	Horizontal		Vertical				
	Acceleration (G)						
Speed (mm/s)	0.2	0.3	0.5	0.7	0.1	0.2	0.3
0	8.5	8.5	7	6	2	2	2
100	8.5	8.5	7	6	2	2	2
200	8.5	8.5	7	6	2	2	2
300	8.5	8.5	7	6	2	2	2
400	8	7	4	3.5	2	2	1.5
500	7	6	3	2	1.5	1.5	1
600	6	6	2	1.5	1	1	0.5

RCP5-SA6C Lead 6

Orientation	Horizontal		Vertical				
	Acceleration (G)						
Speed (mm/s)	0.2	0.3	0.5	0.7	0.1	0.2	0.3
0	16	15	13	12	5	5	5
50	16	15	13	12	5	5	5
100	16	15	13	12	5	5	5
150	16	15	13	12	5	5	5
200	16	15	13	12	5	4.5	4
250	15	12	10	7	4	4	3
300	13	12	6	4	3	2.5	2

RCP5-SA6C Lead 3

Orientation	Horizontal		Vertical				
	Acceleration (G)						
Speed (mm/s)	0.2	0.3	0.5	0.7	0.1	0.2	0.3
0	19	19	19	19	10	10	10
25	19	19	19	19	10	10	10
50	19	19	19	19	10	10	10
75	19	19	19	19	10	10	10
100	19	16	14	12	10	9	8
125	18	14	11	10	7	6	6
150	16	13	10	9	5	4.5	3

RCP5-SA7C Lead 24

Orientation	Horizontal		Vertical			
	Acceleration (G)					
Speed (mm/s)	0.2	0.3	0.5	0.7	0.1	0.2
0	18				2	
200	18				2	
400	18				2	
600	10				1.5	
800	5				1	

RCP5-SA7C Lead 16

Orientation	Horizontal		Vertical				
	Acceleration (G)						
Speed (mm/s)	0.2	0.3	0.5	0.7	0.1	0.2	0.3
0	35				5		
140	35				5		
280	25				3		
420	15				1.5		
560	7				0.5		

RCP5-SA7C Lead 8

Orientation	Horizontal		Vertical				
	Acceleration (G)						
Speed (mm/s)	0.2	0.3	0.5	0.7	0.1	0.2	0.3
0	40				10		
70	40				10		
140	40				7		
210	25				4		
280	15				1.5		

RCP5-SA7C Lead 4

Orientation	Horizontal		Vertical				
	Acceleration (G)						
Speed (mm/s)	0.2	0.3	0.5	0.7	0.1	0.2	0.3
0	40				15		
35	40				15		
70	40				15		
105	40				10		
140	40				5		

RCP5 Series

Rod Type Motor Coupled Specification

RCP5-RA4C Lead 16

Orientation	Horizontal		Vertical					
	Acceleration (G)							
Speed (mm/s)	0.1	0.3	0.5	0.7	1	0.1	0.3	0.5
0	6	6	6	5	3.5	1.5	1.5	1.5
140	6	6	6	5	3.5	1.5	1.5	1.5
280	6	6	6	5	3.5	1.5	1.5	1.5
420	6	6	6	5	3.5	1	1	1
560	6	5.5	4.5	3.5	1	1	1	1
700	5	4	3.5	2	1	1	1	1
840	4	2.5	1.5	1	1	1	0.75	

RCP5-RA4C Lead 10

Orientation	Horizontal		Vertical					
	Acceleration (G)							
Speed (mm/s)	0.1	0.3	0.5	0.7	1	0.1	0.3	0.5
0	15	15	13	12	12	2.5	2.5	2.5
85	15	15	13	12	12	2.5	2.5	2.5
175	15	15	13	12	12	2.5	2.5	2.5
260	12	15	13	12	12	2.5	2.5	2.5
350	12	15	13	12	10	2.5	2.5	2.5
435	12	12	12	7	7	2.25	2.25	2.25
525	11	8	8	4	4	2	2	2
610	6	4	3	2				
700	3	2.5	1.5	1		0.5	0.5	

RCP5-RA4C Lead 5

Orientation	Horizontal		Vertical					
	Acceleration (G)							
Speed (mm/s)	0.1	0.3	0.5	0.7	1	0.1	0.3	0.5
0	28	25	22	20	20	5	5	5
40	28	25	22	20	20	5	5	5
85	28	25	22	20	20	5	5	5
130	28	25	22	20	20	5	5	5
175	28	25	22	20	20	5	5	5
215	28	25	22	20	20	5	5	5
260	28	20	17	16	15	4.5	4.5	4
305	28	16	12	10	8.5	3	3	3
350	17	11	7	6	4	2	2	2

RCP5-RA4C Lead 2.5

Orientation	Horizontal		Vertical					
	Acceleration (G)							
Speed (mm/s)	0.1	0.3	0.5	0.7	1	0.1	0.3	0.5
0	36	36	36	32	30	10	10	10
20	36	36	36	32	30	10	10	10
40	36	36	36	32	30	10	10	10
65	36	36	36	32	30	10	10	10
85	36	36	36	32	30	10	10	10
105	36	36	32	32	30	10	10	10
130	36	32	32	30	30	9	9	8
150	32	32	28	24	20	5	5	5
175	28	18	16	12	12	2	2	2

RCP5-RA6C Lead 20

Orientation	Horizontal		Vertical			
	Acceleration (G)					
Speed (mm/s)	0.2	0.3	0.5	0.7	0.1	0.2
0	6				1.5	
160	6				1.5	
320	6				1.5	
480	4				1	
640	3				0.5	

RCP5-RA6C Lead 12

Orientation	Horizontal		Vertical				
	Acceleration (G)						
Speed (mm/s)	0.2	0.3	0.5	0.7	0.1	0.2	0.3
0	25						
100	25						
200	25						
300	20						
400	10						
500	5						

RCP5-RA6C Lead 6

Orientation	Horizontal		Vertical				
	Acceleration (G)						
Speed (mm/s)	0.2	0.3	0.5	0.7	0.1	0.2	0.3
0	40						
50	40						
100	40						
150	40						
200	35						
250	10						

RCP5-RA6C Lead 3

Orientation	Horizontal		Vertical				
	Acceleration (G)						
Speed (mm/s)	0.2	0.3	0.5	0.7	0.1	0.2	0.3
0	40				20		
25	40				20		
50	40				16		
75	40				12		
100	40				9		
125							

High-output Setting Enabled

RCP5 Series

Slider Type Side-mounted Motor Specification

RCP5-SA4R Lead 16

Orientation	Horizontal			Vertical				
	Acceleration (G)							
Speed (mm/s)	0.1	0.3	0.5	0.7	1	0.1	0.3	0.5
0	4	4	4	4	4	1	1	1
140	4	4	4	4	4	1	1	1
280	4	4	4	4	4	1	1	1
420	4	4	4	4	4	1	1	1
560	4	4	4	4	4	1	1	1
700	4	4	4	4	4	1	1	1
840	4	4	3	3				
980	4	4	2.5	2				
1120	2.5	2.5	1	1			0.75	0.5
1260			1	0.5	0.5			

RCP5-SA4R Lead 10

Orientation	Horizontal			Vertical				
	Acceleration (G)							
Speed (mm/s)	0.1	0.3	0.5	0.7	1	0.1	0.3	0.5
0	10	10	10	8	8	2.25	2.25	2.25
85	10	10	10	8	8	2.25	2.25	2.25
175	10	10	10	8	8	2.25	2.25	2.25
260	9	9	9	8	8	2.25	2.25	2.25
350	9	9	9	8	8	2.25	2.25	2.25
435	8	8	8	8	8	2.25	2.25	2.25
525	8	8	8	7	7	2.25	2.25	2.25
610	8	8	7	5	4	2.25	2	2
700		7	4	3	2		1.5	1
785		4	3	2	1.5			

RCP5-SA4R Lead 5

Orientation	Horizontal			Vertical				
	Acceleration (G)							
Speed (mm/s)	0.1	0.3	0.5	0.7	1	0.1	0.3	0.5
0	12	12	12	10	10	4.5	4.5	4.5
40	12	12	12	10	10	4.5	4.5	4.5
85	12	12	12	10	10	4.5	4.5	4.5
130	11	11	11	10	10	4.5	4.5	4.5
175	10	10	10	10	10	4.5	4.5	4.5
215	10	10	10	10	10	4.5	4.5	4.5
260	10	10	10	10	10	4.5	4.5	4.5
305	10	10	10	10	10	4.5	4.5	4.5
350	10	10	10	10	10	4	4	4
390	10	10	7	6	4	4	3.5	2.5

RCP5-SA4R Lead 2.5

Orientation	Horizontal			Vertical				
	Acceleration (G)							
Speed (mm/s)	0.1	0.3	0.5	0.7	1	0.1	0.3	0.5
0	12	12	12	12	12	9	9	9
20	12	12	12	12	12	9	9	9
40	12	12	12	12	12	9	9	9
65	12	12	12	12	12	9	9	9
85	12	12	12	12	12	9	9	9
105	12	12	12	12	12	9	9	9
130	12	12	12	12	12	9	9	9
150	12	12	12	12	10	9	9	9
175	12	12	12	12	9	9	7	7
195	12	12	12	12	9	9	7	7

RCP5-SA6R Lead 20

Orientation	Horizontal			Vertical				
	Acceleration (G)							
Speed (mm/s)	0.1	0.3	0.5	0.7	1	0.1	0.3	0.5
0	10	10	9	7	6	1	1	1
160	10	10	9	7	6	1	1	1
320	10	10	9	7	6	1	1	1
480	10	10	9	7	6	1	1	1
640	10	10	8	6	5	1	1	1
800	10	9	6.5	4.5	3	1	1	1
960		8	5	3.5	2			
1120		6	3	2	1.5			0.5
1280			1	0.5	0.5			

RCP5-SA6R Lead 12

Orientation	Horizontal			Vertical				
	Acceleration (G)							
Speed (mm/s)	0.1	0.3	0.5	0.7	1	0.1	0.3	0.5
0	15	15	12.5	11	10	2.5	2.5	2.5
100	15	15	12.5	11	10	2.5	2.5	2.5
200	15	15	12.5	11	10	2.5	2.5	2.5
300	15	15	12.5	11	10	2.5	2.5	2.5
400	15	14	11	10	8.5	2.5	2.5	2.5
500	15	13	10	8	6.5	2.5	2.5	2.5
600	15	12	9	6	4	2.5	2.5	2.5
700	12	10	8	4	2.5	2.5	2	1.5
800	10	7	5	2	1	2	1	0.5
900		4	2	1				

RCP5-SA6R Lead 6

Orientation	Horizontal			Vertical				
	Acceleration (G)							
Speed (mm/s)	0.1	0.3	0.5	0.7	1	0.1	0.3	0.5
0	25	25	20	16	14	6	6	6
50	25	25	20	16	14	6	6	6
100	25	25	20	16	14	6	6	6
150	25	25	20	16	14	6	6	6
200	25	25	20	16	14	6	6	6
250	25	25	20	16	14	6	6	5.5
300	25	25	20	15	11	6	5.5	5
350	25	20	14	12	9	5.5	4.5	4
400	25	16	10	8	6.5	4.5	3.5	3
450	18	12	6	5	2.5	2.5	2	1.5

RCP5-SA6R Lead 3

Orientation	Horizontal			Vertical				
	Acceleration (G)							
Speed (mm/s)	0.1	0.3	0.5	0.7	1	0.1	0.3	0.5
0	25	25	25	25	25	12	12	12
25	25	25	25	25	25	12	12	12
50	25	25	25	25	25	12	12	12
75	25	25	25	25	25	12	12	12
100	25	25	25	25	25	12	12	12
125	25	25	25	25	25	12	12	12
150	25	25	25	25	22.5	12	11	10
175	25	25	25	20	19	11	9	8
200	25	25	20	18	12	9	7	6
225	25	18	12	6	4	5	3	

RCP5-SA7R Lead 24

Orientation	Horizontal			Vertical				
	Acceleration (G)							
Speed (mm/s)	0.1	0.3	0.5	0.7	1	0.1	0.3	0.5
0	20	20	18	16	14	3	3	3
200	20	20	18	16	14	3	3	3
400	20	20	18	16	14	3	3	3
600	20	16	15	10	9	3	3	3
800	16	12	10	6	4		3	2.5
1000		8	4.5	2	1			1

RCP5-SA7R Lead 16

Orientation	Horizontal			Vertical				
	Acceleration (G)							
Speed (mm/s)	0.1	0.3	0.5	0.7	1	0.1	0.3	0.5
0	40	40	35	28	27	8	8	8
140	40	40	35	28	27	8	8	8
280	40	38	35	25	24	8	8	8
420	35	25	20	15	10	6	5	4.5
560	25	20	15	10	6	5	4	3
700	20	15	8	5	3	3	2	1.5
840		6	2					

RCP5-SA7R Lead 8

Orientation	Horizontal			Vertical				
	Acceleration (G)							
Speed (mm/s)	0.1	0.3	0.5	0.7	1	0.1	0.3	0.5
0	45	45	45	40	40	16	16	16
70	45	45	45	40	40	16	16	16
140	45	45	40	38	35	16	16	16
210	45	40	35	30	24	11	10	9.5
280	40	30	25	20	15	9	8	7
350	35	20	9	4		7	5	4
420	25	7				5	1	
490	13					1		

RCP5-SA7R Lead 4

Orientation	Horizontal			Vertical				
	Acceleration (G)							
Speed (mm/s)	0.1	0.3	0.5	0.7	1	0.1	0.3	0.5
0	45	45	45	40	40	25	25	25
35	45	45	45	40	40	25	25	25
70	45	45	45	40	40	25	25	25
105	45	45	45	40	35	22	20	19
140	45	45	35	30	25	16	14	12
175	45	30	18			11	7	5
210	40					4		

RCP5 Series

Rod Type Side-mounted Motor Specification

RCP5-RA4R Lead 16

Orientation	Horizontal			Vertical				
	Acceleration (G)							
Speed (mm/s)	0.1	0.3	0.5	0.7	1	0.1	0.3	0.5
0	5	5	4.5	3	2.5	1	1	1
140	5	5	4.5	3	2.5	1	1	1
280	5	5	4.5	3	2	1	1	1
420	5	5	4.5	3	2	1	1	1
560		5	4.5	2.5	2	1	1	1
700		4.5	3.5	2	1.5			
840		3	2.5	1	0.5			0.5

RCP5-RA4R Lead 10

Orientation	Horizontal			Vertical				
	Acceleration (G)							
Speed (mm/s)	0.1	0.3	0.5	0.7	1	0.1	0.3	0.5
0	12	12	10	10	8	2.5	2.5	2.5
85	12	12	10	10	8	2.5	2.5	2.5
175	12	12	10	10	6	2.5	2.5	2.5
260	12	12	10	10	5	2.5	2.5	2.5
350	12	12	10	8	5	2.5	2.5	2.5
435	12	10	8	6	4	2.5	2.5	2.5
525	12	8	6	3	2	2.5	2.5	2
610		5	2			2	1.5	

RCP5-RA4R Lead 5

RCP5-BA4/BA4U

Orientation	Horizontal
Speed (mm/s)	Acceleration (G)
0	1.5
200	1.5
800	1.5
1000	1
1200	0.5

RCP5-BA6/BA6U

Orientation	Horizontal
Speed (mm/s)	Acceleration (G)
0	6
600	6
800	4
1000	3
1500	1

RCP5-BA7/BA7U

Orientation	Horizontal
Speed (mm/s)	Acceleration (G)
0	16
100	16
1000	5
1400	2
1600	2

Selection Guideline (Selecting the Allowable Load for the Radial Cylinder)

The radial cylinder has a built-in guide, so loads up to a certain level can be applied to the rod without using an external guide. Refer to the graphs below for the allowable load mass. If the allowable load will be exceeded under the required operating conditions, add an external guide.

Allowable Load Mass for a Horizontally Mounted RCP5

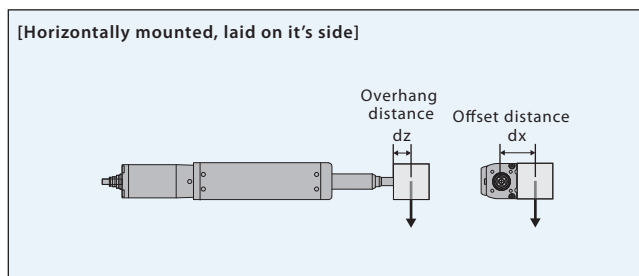
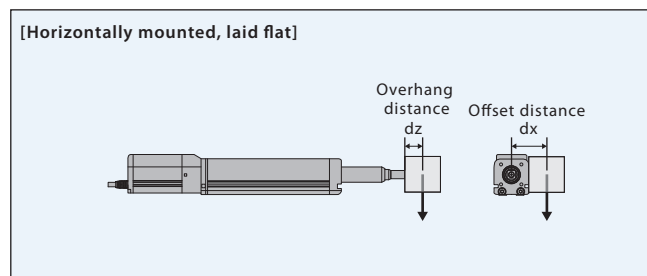

RCP5-RA4□/RA6□/RA7□

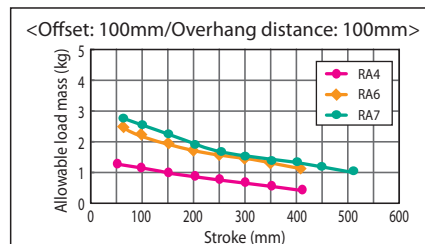
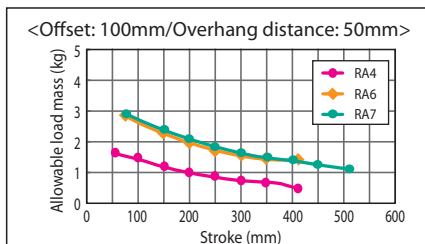
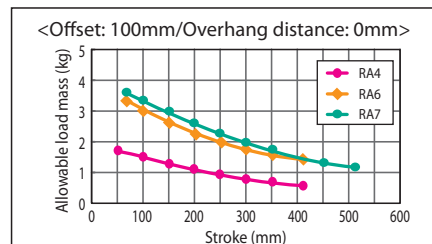
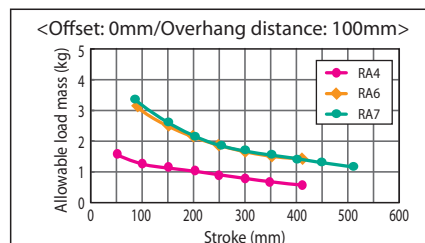
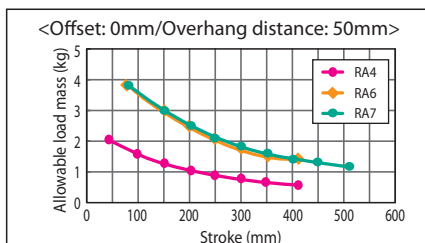
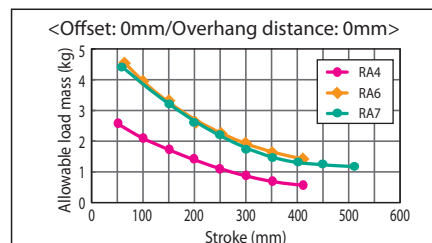

RCP5-RA8□/RA10□

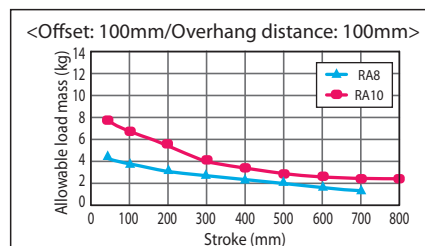
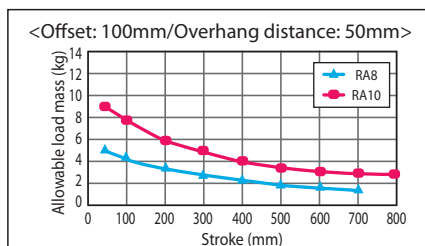
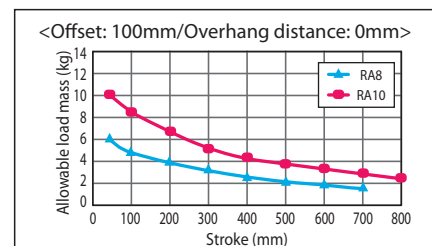
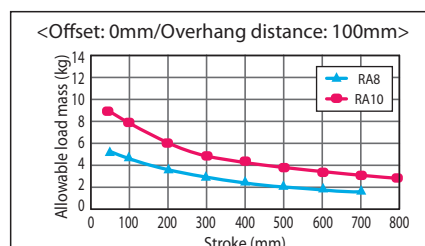
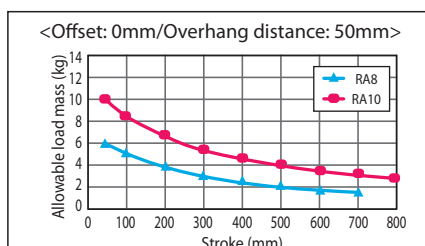
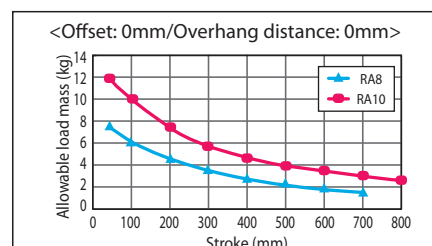

■ Allowable Load Mass for a Vertically Mounted RCP5

[Vertically mounted]

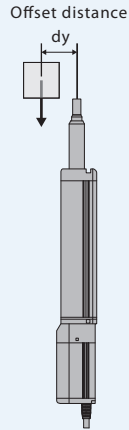
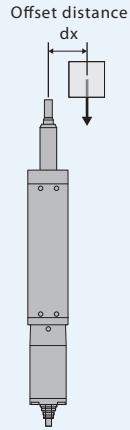

Allowable load calculation conditions.
Load mass corresponding to a product traveling life of 5,000 km, considering moments generated by acceleration/deceleration.
(Maximum speed in the specification of speed.)

RCP5-RA4□

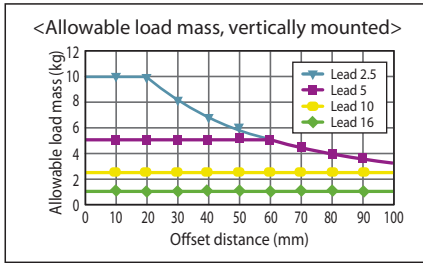

RCP5-RA6□

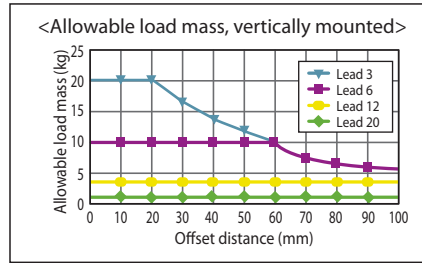

RCP5-RA7□

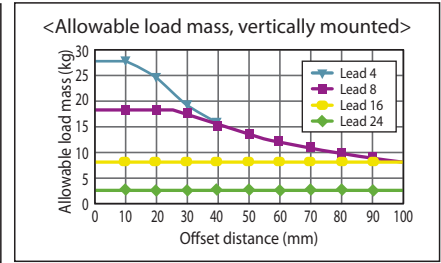

RCP5-RA8□

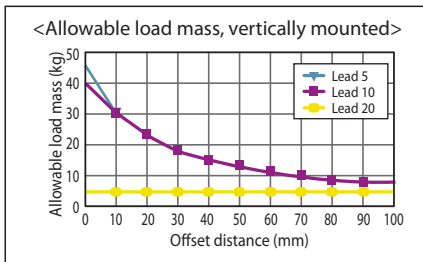

RCP5-RA10□

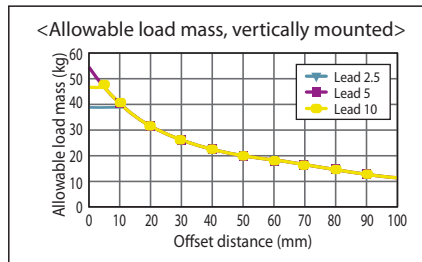

System Configuration

Single-axis Specification

→ Refer to P. 69

Option

PC compatible software
(Refer to P. 86)
RS232 connection type
<Model number: RCM-101-MW>
USB connection type
<Model number: RCM-101-USB>

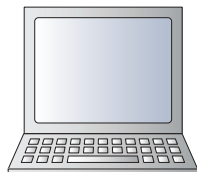

Option

Teaching pendant
(Refer to P. 86)
<Model number: TB-01-C>



5m

PLC



Field network
DeviceNet, CC-Link, PROFIBUS-DP, MECHATROLINK (I, II),
CompoNet, EtherCAT, EtherNet/IP, PROFINET IO

PIO flat cable
(Refer to P. 90)
<Model number: CB-MSEP-PIO020>
Standard length: 2m
Comes with any PIO spec. controller

Absolute battery unit
Comes with the simple absolute type
<Model number: SEP-ABU> (DIN rail mount)
<Model number: SEP-ABUS> (Screw mount)



Standard: 0.5m



Simple absolute battery
<Model number: AB-7>

Controller
(Refer to P. 69)
<Model number: PCON-CA/CFA>



DC24V power supply
<Model number: PS-241 (100V input)>
<Model number: PS-242 (200V input)>

<Connectable Actuators>

Actuators indicated in green are of the pulse motor specification.

Integrated motor-encoder cable
<Model number: CB-PSEP-MPA □□□>
Standard lengths: 1m/3m/5m
(Refer to P. 90)
Supplied with the actuator

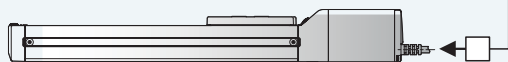

Actuator RCP2 Series

Integrated motor-encoder cable
<Model number: CB-RPSEP-MPA □□□>
Standard lengths: 1m/3m/5m
(Refer to P. 90)
Supplied with the actuator

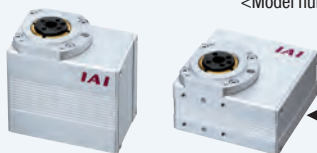

Actuator RCP2, Small Rotary
(RCP2-RTBS/RTCS)

Integrated motor-encoder cable
<Model number: CB-CA-MPA □□□>
<Model number: CB-CAN-MPA □□□-RB>
Standard lengths: 1m/3m/5m
(Refer to P. 89)
Supplied with the actuator



Actuator RCP4 Series

Integrated motor-encoder cable
<Model number: CB-APSEP-MPA □□□>
Standard lengths: 1m/3m/5m
(Refer to P. 89)
Supplied with the actuator



Actuator RCP3 Series

Integrated motor-encoder cable
<Model number: CB-CAN-MPA □□□>
<Model number: CB-CAN-MPA □□□-RB>
Standard lengths: 1m/3m/5m
(Refer to P. 89)
Supplied with the actuator



Actuator RCP5 Series

Integrated motor-encoder cable (for RCP5-RA8C/8R/10C/10R)
<Model number: CB-CFA3-MPA □□□>
<Model number: CB-CFA3-MPA □□□-RB>
Standard lengths: 1m/3m/5m
(Refer to P. 89)

Multi-axis Specification (8-axis Specification/6-axis Specification with PLC Control Function) → Refer to P. 77

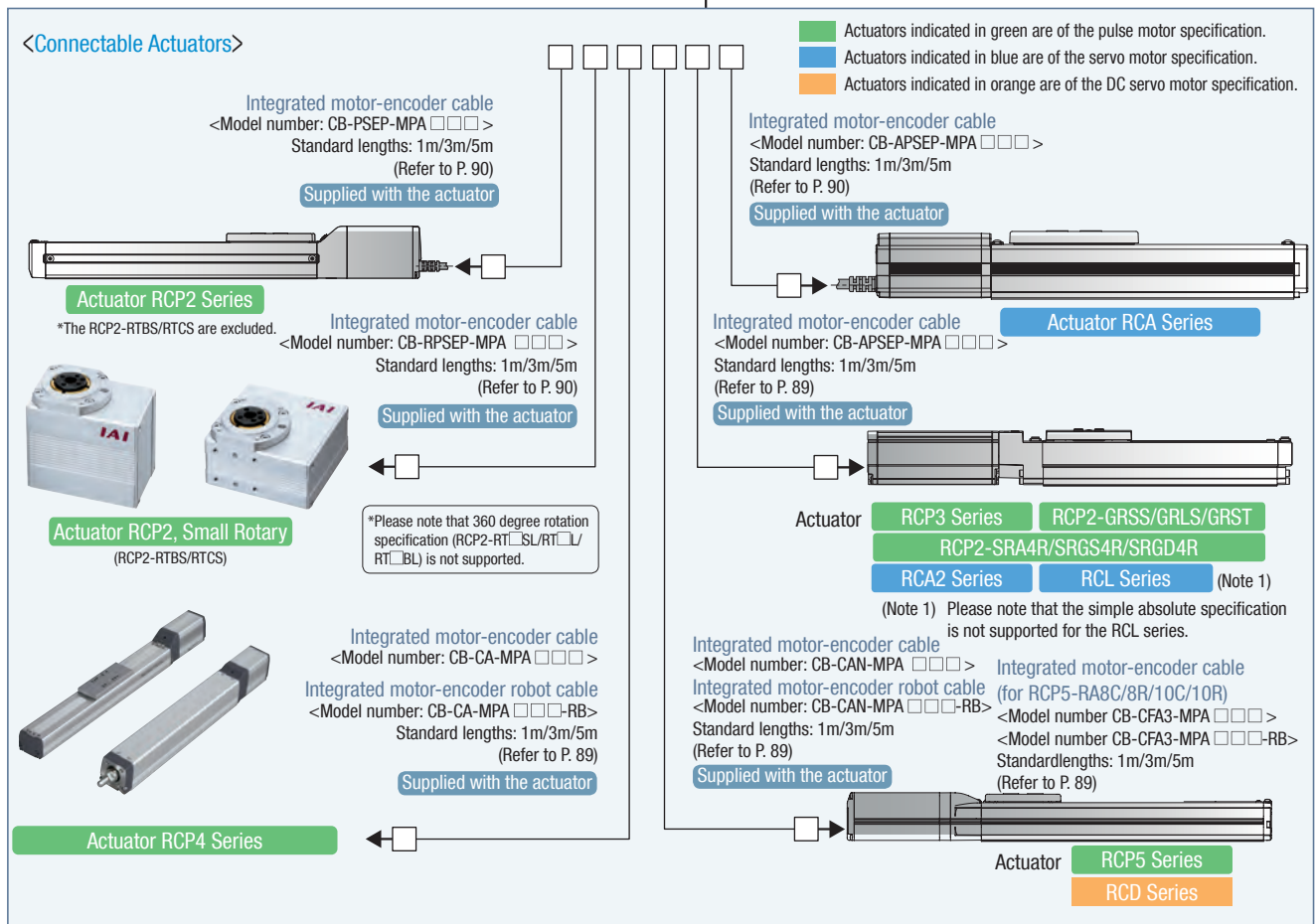
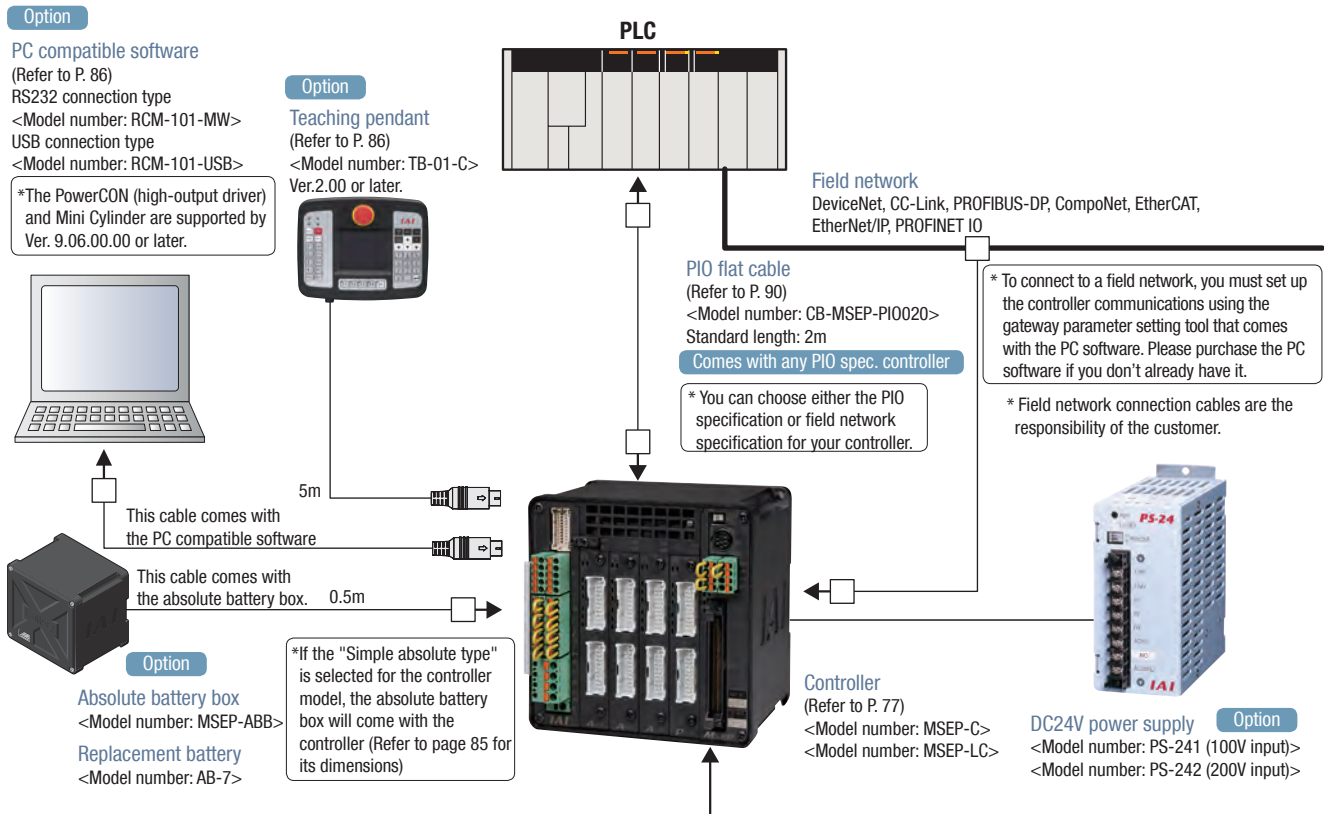

PCON-CA/CFA

The Position Controllers for
RCP5/RCP4 (PowerCON Type)
RCP3/RCP2



1 The built-in high-output driver designed for the RCP5/RCP4 achieves greater torque when operated at high speed

The newly developed high-output driver (patent pending) has achieved significant improvements compared to the conventional model (RCP2 Series), with a 1.4 times higher acceleration rate, 1.5 times higher maximum speed, and twice as much in payload.

(*) The rates of improvement vary depending on the type.

(*) The RCP3/RCP2 are also supported.

(*) PCON-CA only

Acceleration/ deceleration	RCP2	0.7G	1.4 times
	RCP5	1.0G	
Maximum speed	RCP2	1,000mm/s	1.5 times
	RCP5	1,440mm/s	
Payload	RCP2	6kg	2 times
	RCP5	12kg	

2 Battery-less absolute encoder compatibility

The RCP5 equipped with a battery-less absolute encoder is supported. Since no battery is needed to retain position data, less space is required in the control panel, which in turn leads to lower cost of your equipment.



3 A common board leads to improved ease of maintenance

While conventional controllers require a separate set of boards for each actuator, the PCON-CA/CFA use common boards for all actuators, meaning that actuators of different models such as RCP5, RCP4, RCP3 and RCP2 can be operated simply by changing the controller settings. The result is significant reduction in maintenance stock.

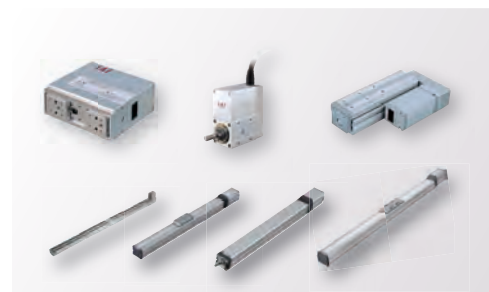

4 Smart tuning function, maintenance information, calendar function

You are able to set the optimal acceleration rate based on the transport load, by using the smart tuning function. In addition, you can record the number of times the actuator has moved and the distance it has traveled, for maintenance purposes.

(*) You need PC compatible software Ver. 8.03.00.00 or later or a TB-01 (teaching pendant) to use the smart tuning function.

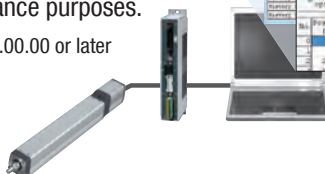

List of Models

Position Controllers for ROBO Cylinder: PCON-CA/CFA

I/O type		Positioner type	Pulse-train type *1	Field network type								
				DeviceNet	CC-Link	PROFIBUS	CompoNet	MECHATROLINK	EtherCAT	EtherNet/IP	PROFINET	
I/O type model number		NP/PN	PLN/PLP	DV	CC	PR	CN	ML	EC	EP	PRT	
PCON-CA	Battery-less absolute specification	—	—	—	—	—	—	—	—	—	—	
	Incremental specification	—	—	—	—	—	—	—	—	—	—	
		With absolute battery	—	—	—	—	—	—	—	—	—	—
		Without absolute battery	—	—	—	—	—	—	—	—	—	—
PCON-CFA	Battery-less absolute specification	—	—	—	—	—	—	—	—	—		
	Incremental specification	—	—	—	—	—	—	—	—	—	—	

*1 If the RCP5 is used with pulse-train I/Os, the actuator must complete a home return prior to operation, as with any incremental actuator.

Model Specification Items

<Controller>

PCON — [] — [] — [] — [] — [] — 0 — [] — []

Series Type Motor type Encoder type I/O type I/O cable length Power supply voltage Simple absolute specification Actuator mounting specification

CA	Standard type					0	DC24V		
CFA	60P/86P motor type								
		WAI	Battery-less absolute specification						
		SA	Simple absolute specification						
20P	20□ size pulse motor								
20SP	20□ size pulse motor (Only for RCP3-RA2 high-thrust type)								
28P	28□ size pulse motor								
28SP	28□ size pulse motor (Only for RCP2-RA3C)								
35P	35□ size pulse motor								
42P	42□ size pulse motor								
56P	56□ size pulse motor								
60P	60□ size pulse motor								
86P	86□ size pulse motor								
		NP	PIO (NPN) specification		0	No cable		(Blank)	Battery-less absolute specification
		PLN	Pulse-train (NPN) specification		2	2m		AB	Simple absolute specification (With absolute battery. No battery unit included)
		PN	PIO (PNP) specification		3	3m		ABU	Simple absolute specification (With absolute battery and battery unit)
		PLP	Pulse-train (PNP) specification		5	5m		ABUN	Simple absolute specification (Without absolute battery and battery unit)
		DV	DeviceNet connection specification						
		CC	CC-Link connection specification						
		PR	PROFIBUS-DP connection specification						
		CN	CompoNet connection specification						
		ML	MECHATROLINK I,II connection specification						
		EC	EtherCAT connection specification						
		EP	EtherNet/IP connection specification						
		PRT	PROFINET IO connection specification						

* If a network connection specification (I/O type-DV, CC, PR, CN, ML, EC or EP) is selected, the I/O cable length becomes "0" (no cable).

* The PCON-CFA does not support the simple absolute specification.

(Blank)	Screw mounting specification
DN	DIN rail mounting specification

* The mounting type (screw or DIN rail) of the absolute battery unit and the controller must be the same.

PIO I/O Interface

Input Part External Input Specifications

Item	Specification
Input voltage	DC24V ±10%
Input current	5mA, 1 circuit
ON/OFF voltage	ON voltage: DC18V min. OFF voltage: DC6V max.

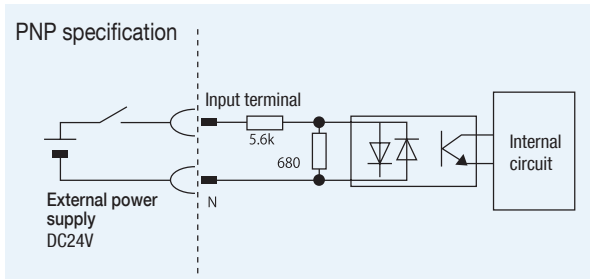
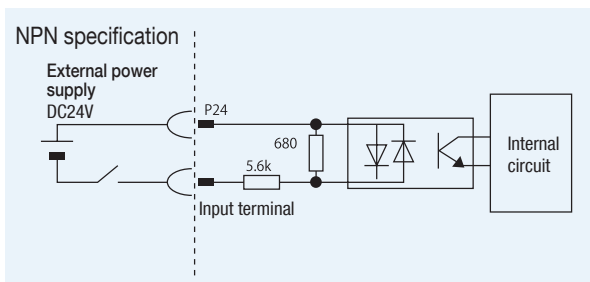

Output Part External Output Specifications

Item	Specification
Load voltage	DC24V
Maximum load current	50mA, 1 circuit
Leak current	2mA max. per point

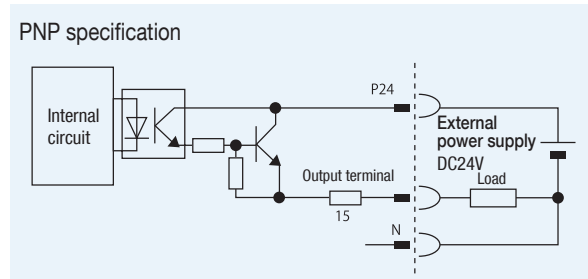
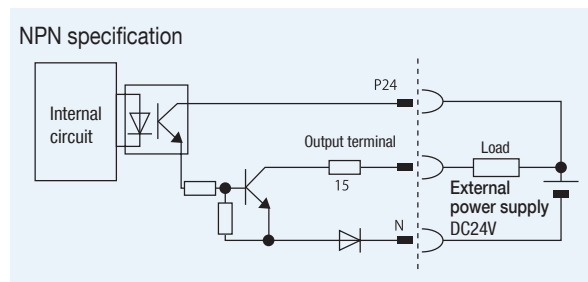

Types of PIO Patterns (Control Patterns)

This controller supports seven types of control methods. Please select the PIO pattern that best suits your purpose in Parameter No. 25, "PIO Pattern Selection".

Type	Set value of parameter No. 25	Mode	Overview
PIO pattern 0	0 (factory setting)	Positioning mode (standard type)	<ul style="list-style-type: none"> Number of positioning points: 64 points Position number command: Binary Coded Decimal (BCD) Zone signal output*: 1 point Position zone signal output**: 1 point
PIO pattern 1	1	Teaching mode (teaching type)	<ul style="list-style-type: none"> Number of positioning points: 64 points Position number command: Binary Coded Decimal (BCD) Position zone signal output**: 1 point Jog (inching) operation using PIO signals is supported. Current position data can be written to the position table using PIO signals.
PIO pattern 2	2	256-point mode (256 positioning points)	<ul style="list-style-type: none"> Number of positioning points: 256 points Position number command: Binary Coded Decimal (BCD) Position zone signal output**: 1 point
PIO pattern 3	3	512-point mode (512 positioning points)	<ul style="list-style-type: none"> Number of positioning points: 512 points Position number command: Binary Coded Decimal (BCD) No zone signal output
PIO pattern 4	4	Solenoid valve mode 1 (7-point type)	<ul style="list-style-type: none"> Number of positioning points: 7 points Position number command: Individual number signal ON Zone signal output*: 1 point Position zone signal output**: 1 point
PIO pattern 5	5	Solenoid valve mode 2 (3-point type)	<ul style="list-style-type: none"> Number of positioning points: 3 points Position number command: Individual number signal ON Completion signal: A signal equivalent to a LS (limit switch) signal can be output. Zone signal output*: 1 point Position zone signal output**: 1 point
PIO pattern 6 (Note 1)	6	Pulse-train control mode	<ul style="list-style-type: none"> Differential pulse input (200 kpps max.) Home return function Zone signal output*: 2 points No feedback pulse output

* Zone signal output: Please set the desired zone range in Parameter No. 1/2 or 23/24, and it will remain effective once home return is completed.

** Position zone signal output: This command function relates to the position number. Set the desired zone range in the position table, and this function will only become enabled when the corresponding position is specified; it will be disabled for all other position commands.

(Note 1) Pulse train control mode is available only the pulse train control type is specified (PCON-CA-PLN and PLP) at the time of purchase.

PIO Patterns and Signal Assignments

The table below lists the signal assignments for the I/O flat cable under different PIO patterns. Connect an external device (such as a PLC) according to this table.

Pin number	Category	PIO function	Parameter No. 25, "PIO pattern selection"					
			0	1	2	3	4	5
			Positioning mode	Teaching mode	256-point mode	512-point mode	Solenoid valve mode 1	Solenoid valve mode 2
	Input	Number of positioning points	64 points	64 points	256 points	512 points	7 points	3 points
		Home return signal	○	○	○	○	○	×
		Jog signal	×	○	×	×	×	×
		Teaching signal (writing of current position)	×	○	×	×	×	×
	Output	Brake release	○	×	○	○	○	○
		Moving signal	○	○	×	×	×	×
		Zone signal	○	△ (Note 1)	△ (Note 1)	×	○	○
		Position zone signal	○	○	○	×	○	
1A	24V	P24						
2A	24V	P24						
3A	Pulse input	—						
4A		—						
5A	Input	IN0	PC1	PC1	PC1	PC1	ST0	ST0
6A		IN1	PC2	PC2	PC2	PC2	ST1	ST1 (JOG+)
7A		IN2	PC4	PC4	PC4	PC4	ST2	ST2 (Non-Functional)
8A		IN3	PC8	PC8	PC8	PC8	ST3	—
9A		IN4	PC16	PC16	PC16	PC16	ST4	—
10A		IN5	PC32	PC32	PC32	PC32	ST5	—
11A		IN6	—	MODE	PC64	PC64	ST6	—
12A		IN7	—	JISL	PC128	PC128	—	—
13A		IN8	—	JOG+	—	PC256	—	—
14A		IN9	BKRL	JOG-	BKRL	BKRL	BKRL	BKRL
15A		IN10	RMOD	RMOD	RMOD	RMOD	RMOD	RMOD
16A		IN11	HOME	HOME	HOME	HOME	HOME	—
17A		IN12	*STP	*STP	*STP	*STP	*STP	—
18A		IN13	CSTR	CSTR/PWRT	CSTR	CSTR	—	—
19A		IN14	RES	RES	RES	RES	RES	RES
20A	IN15	SON	SON	SON	SON	SON	SON	
1B	Output	OUT0	PM1 (ALM1)	PM1 (ALM1)	PM1 (ALM1)	PM1 (ALM1)	PE0	LS0
2B		OUT1	PM2 (ALM2)	PM2 (ALM2)	PM2 (ALM2)	PM2 (ALM2)	PE1	LS1 (TRQS)
3B		OUT2	PM4 (ALM4)	PM4 (ALM4)	PM4 (ALM4)	PM4 (ALM4)	PE2	LS2 (Note2)
4B		OUT3	PM8 (ALM8)	PM8 (ALM8)	PM8 (ALM8)	PM8 (ALM8)	PE3	—
5B		OUT4	PM16	PM16	PM16	PM16	PE4	—
6B		OUT5	PM32	PM32	PM32	PM32	PE5	—
7B		OUT6	MOVE	MOVE	PM64	PM64	PE6	—
8B		OUT7	ZONE1	MODES	PM128	PM128	ZONE1	ZONE1
9B		OUT8	PZONE/ZONE2	PZONE/ZONE1	PZONE/ZONE1	PM256	PZONE/ZONE2	PZONE/ZONE2
10B		OUT9	RMDS	RMDS	RMDS	RMDS	RMDS	RMDS
11B		OUT10	HEND	HEND	HEND	HEND	HEND	HEND
12B		OUT11	PEND	PEND/WEND	PEND	PEND	PEND	—
13B		OUT12	SV	SV	SV	SV	SV	SV
14B		OUT13	*EMGS	*EMGS	*EMGS	*EMGS	*EMGS	*EMGS
15B		OUT14	*ALM	*ALM	*ALM	*ALM	*ALM	*ALM
16B	OUT15	LOAD/TRQS *ALML	*ALML	LOAD/TRQS *ALML	LOAD/TRQS *ALML	LOAD/TRQS *ALML	*ALML	
17B	Pulse input	—						
18B		—						
19B	0V	N						
20B	0V	N						

(Note) In the table above, asterisk * symbol accompanying each code indicates a negative logic signal. PM1 to PM8 are alarm binary code output signals that are used when an alarm generates.

(Note 1) In all PIO patterns other than 3, this signal can be switched with PZONE by setting Parameter No. 149 accordingly.

(Note 2) The setting will not become effective until the home return is completed.

Reference) Negative logic signal

Signals denoted by * are negative logic signals. Negative logic input signals are processed when turned OFF. Negative logic output signals normally remain ON while the power is supplied, and turn OFF when the signal is output.

Pulse-train Control Circuit

Host Unit = Differential Type

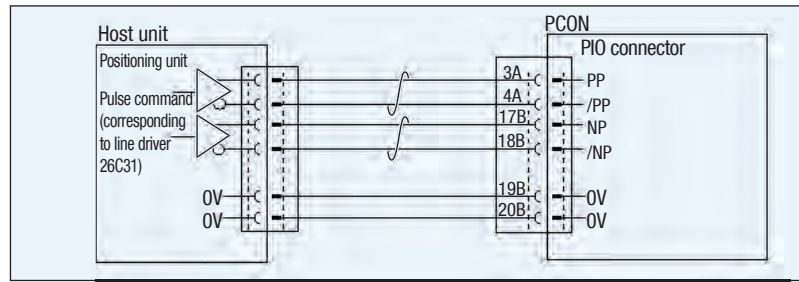

Host Unit = Open Collector Type

The AK-04 (optional) is needed to input pulses.

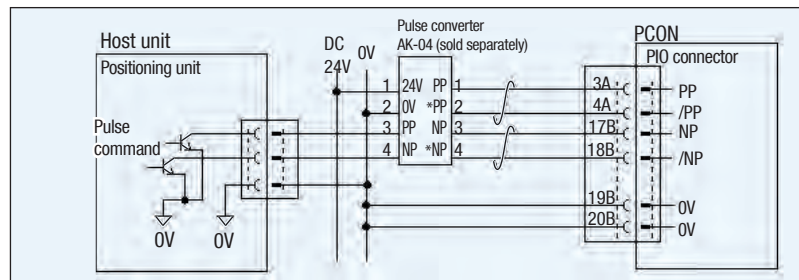

Caution: Use the same power supply for open collector input/output to/from the host and for the AK-04.

Command Pulse Input Patterns

	Command pulse-train pattern	Input terminal	Forward	Reverse	
Negative logic	Forward pulse-train	PP · /PP			
	Reverse pulse-train	NP · /NP			
	A forward pulse-train indicates the amount of motor rotation in the forward direction, while a reverse pulse-train indicates the amount of motor rotation in the reverse direction.				
	Pulse-train	PP · /PP			
	Sign	NP · /NP	Low	High	
	The command pulses indicate the amount of motor rotation, while the sign indicates the rotating direction.				
Positive logic	Phase A/B pulse-train	PP · /PP			
	Phase A/B pulse-train	NP · /NP			
	Command phases A and B having a 90° phase difference (multiplier is 4) indicate the amount of rotation and the rotating direction.				
	Forward pulse-train	PP · /PP			
	Reverse pulse-train	NP · /NP			
Positive logic	Pulse-train	PP · /PP			
	Sign	NP · /NP	High	Low	
Positive logic	Phase A/B pulse-train	PP · /PP			
	Phase A/B pulse-train	NP · /NP			

I/O Signals in Pulse-train Control Mode

The table below lists the signal assignments for the flat cable in the pulse-train control mode. Connect an external device (such as PLC) according to this table.

Pin number	Category	I/O number	Signal abbreviation	Signal name	Parameter No. 25, "PIO pattern 6"
1A	24V		P24	Power supply	I/O power supply +24V
2A	24V		P24	Power supply	I/O power supply +24V
3A	Pulse input		PP	Differential pulse-train input (+)	Differential pulses are input from the host. Up to 200kpps can be input.
4A			/PP	Differential pulse-train input (-)	
5A	Input	IN0	SON	Servo ON	The servo is ON while this signal is ON, and OFF while the signal is OFF.
6A		IN1	RES	Reset	Present alarms are reset when this signal is turned ON.
7A		IN2	HOME	Home return	Home return operation is performed when this signal is turned ON.
8A		IN3	TL	Torque limit selection	When this signal is turned ON, the motor torque is limited to the value set by the parameter.
9A		IN4	CSTP	Forced stop	The actuator is forcibly stopped when this signal has remained ON for 16ms or more. The actuator decelerates to a stop at the torque set in the controller and the servo turns OFF.
10A		IN5	DCLR	Deviation counter clear	This signal clears the deviation counter.
11A		IN6	BKRL	Forced brake release	The brake is forcibly released.
12A		IN7	RMOD	Operation mode switching	The operation mode can be switched when the MODE switch on the controller is set to AUTO. (AUTO when this signal is OFF, and to MANU when the signal is ON.)
13A		IN8	NC	—	Not used
14A		IN9	NC	—	Not used
15A		IN10	NC	—	Not used
16A		IN11	NC	—	Not used
17A		IN12	NC	—	Not used
18A		IN13	NC	—	Not used
19A		IN14	NC	—	Not used
20A	IN15	NC	—	Not used	
1B	Output	OUT0	PWR	System ready	This signal turns ON when the controller becomes ready after the main power has been turned on.
2B		OUT1	SV	Servo ON status	This signal turns ON when the servo is ON.
3B		OUT2	INP	Positioning complete	This signal turns ON when the amount of remaining travel pulses in the deviation counter falls within the in-position band.
4B		OUT3	HEND	Home return complete	This signal turns ON upon completion of home return.
5B		OUT4	TLR	Torque limited	This signal turns ON upon reaching the torque limit while the torque is limited.
6B		OUT5	*ALM	Controller alarm status	This signal turns ON when the controller is normal, and turns OFF when an alarm generates.
7B		OUT6	*EMGS	Emergency stop status	This signal turns ON when the emergency stop of the controller is cancelled, and turns OFF when an emergency stop is actuated.
8B		OUT7	RMDS	Operation mode status	The operation mode status is output. This signal turns ON when the controller is in the manual mode.
9B		OUT8	ALM1	Alarm code output signal	An alarm code is output when an alarm generates. For details, refer to the operation manual.
10B		OUT9	ALM2		
11B		OUT10	ALM4		
12B		OUT11	ALM8		
13B		OUT12	*ALML	Minor failure alarm	This signal is output when a message-level alarm generates. This signal turns off when an alarm has been generated.
14B		OUT13	NC	—	Not used
15B		OUT14	ZONE1	Zone signal 1	This signal turns ON when the current position of the actuator falls within the parameter-set range.
16B	OUT15	ZONE2	Zone signal 2		
17B	Pulse input		NP	Differential pulse-train input (+)	Differential pulses are input from the host. Up to 200kpps can be input.
18B			/NP	Differential pulse-train input (-)	
19B	0V		N	Power supply	I/O power supply 0V
20B	0V		N	Power supply	I/O power supply 0V

(Note) * indicates a negative logic signal. Negative logic signals are normally ON while the power is supplied, and turn OFF when the signal is output.

(Note) The number of encoder pulses is 800 with all RCP5 series models. For details, refer to the operation manual.

Field Network Specification: Explanation of Operation Modes

If the PCON-CA is controlled via a field network, you can select one of the following five modes to operate the actuator. Please note that the data areas required on the PLC side will vary depending on the mode.

Mode Description

	Mode	Description
0	Remote I/O mode	Similarly to the PIO specification, this mode operates by directing bytes to ON/OFF via a network. The number of positioning points and functions will vary depending on the operation patterns (PIO patterns) set by the controller's parameters.
1	Position/simple direct value mode	The target position value is directly inputted, while all other operational conditions (speed, acceleration, etc) are set by indicating the position number corresponding to the desired operating conditions from the position data table.
2	Half direct value mode	The actuator is operated by directly inputting values for speed, acceleration rate and push current, as well as the target position.
3	Full direct value mode	The actuator is operated by directly inputting values for the target position, speed, acceleration rate and push current, etc. In addition, you are able to read the current position, current speed, and the specified current, etc.
4	Remote I/O mode 2	This mode is the same as the remote I/O mode above, with the added functionality of reading current position and the specified current.

Required Data Size for Each Network

		DeviceNet	CC-Link	PROFIBUS-DP	CompoNet	MECHATROLINK I, II	EtherCAT	EtherNet/IP	PROFINET IO
0	Remote I/O mode	2 bytes	1 station	2 bytes	2 bytes	*	2 bytes	2 bytes	2 bytes
1	Position/simple direct value mode	8 bytes	1 station	8 bytes	8 bytes	*	8 bytes	8 bytes	8 bytes
2	Half direct value mode	16 bytes	2 stations	16 bytes	16 bytes	*	16 bytes	16 bytes	16 bytes
3	Full direct value mode	32 bytes	4 stations	32 bytes	32 bytes	*	32 bytes	32 bytes	32 bytes
4	Remote I/O mode 2	12 bytes	1 station	12 bytes	12 bytes	*	12 bytes	12 bytes	12 bytes

* No required data size is set for MECHATROLINK I and II.

List of Functions by Operation Mode

	Remote I/O mode	Position/simple direct value mode	Half direct value mode	Full direct value mode (Note 1)	Remote I/O mode 2
Number of positioning input	512 points	768 points	Unlimited	Unlimited	512 points
Operation by direct position data input	×	○	○	○	×
Direct speed/acceleration input	×	×	○	○	×
Push-motion operation	○	○	○	○	○
Current position read	×	○	○	○	○
Current speed read	×	×	○	○	×
Operation by position number input	○	○	×	×	○
Completed position number read	○	○	×	×	○

* ○ indicates that the operation is supported, and X indicates that it is not supported.

(Note 1) Please note that the MECHATROLINK specification does not support the full direct value mode.

External Dimensions

PCON-CA

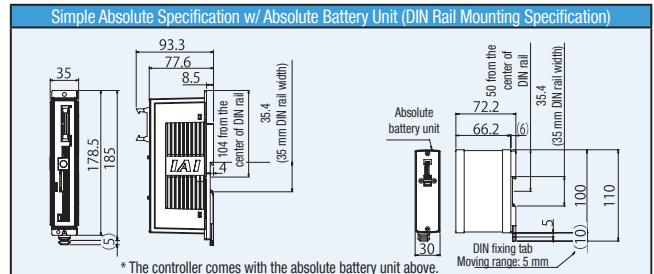
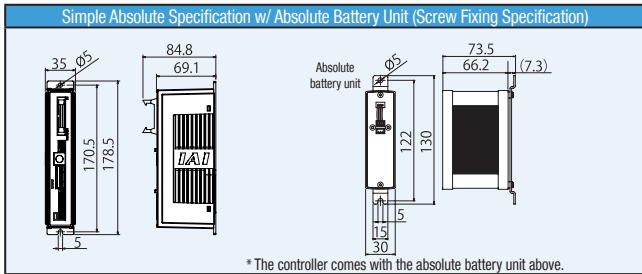
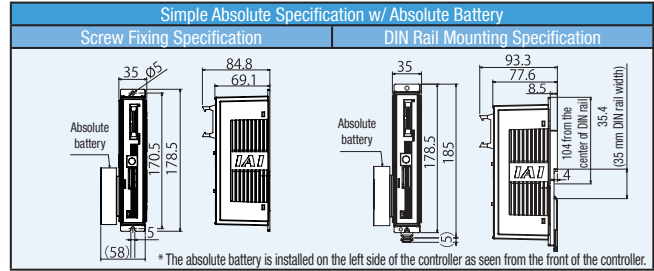
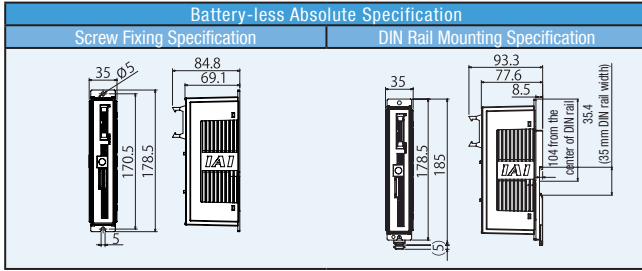

PCON-CFA

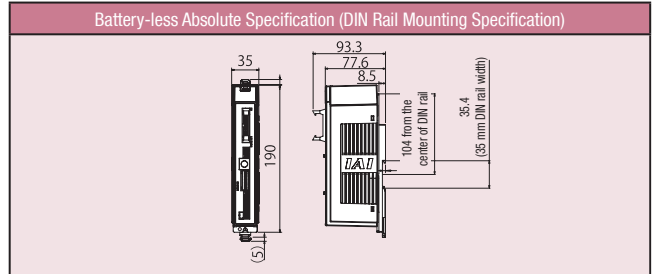
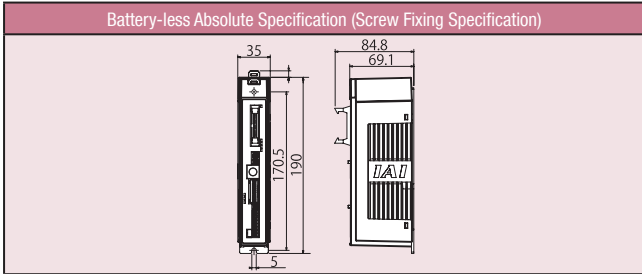

Specification List

Item	Description			
	PCON-CA	PCON-CFA		
Number of controlled axes	1 axis			
Power-supply voltage	DC24V±10%			
Load current (including control-side current consumption) (Note 1)	RCP2 RCP3	Motor type	20P, 28P, 28SP 42P, 56P 60P, 86P	1A max. 2.2A max.
		RCP4 RCP5	Motor type	28P, 35P 42P, 56P, 42SP 60P, 86P, 56SP
			6A max.	
			6A max.	
Electromagnetic brake power (for actuator with brake)	DC24V±10%	0.15A max.	DC24V±10%	0.5A max.
Rush current (Note 2)	8.3A		10A	
Momentary power failure resistance	500µs max.			
Supported encoder	Battery-less absolute encoder/incremental encoder			
Actuator cable length	20m max.			
External interface	PIO specification	Dedicated DC24V signal inputs/outputs (NPN/PNP selectable) --- Up to 16 input points, up to 16 output points, cable length up to 10m		
	Field network specification	DeviceNet, CC-Link, PROFIBUS-DP, CompoNet, MECHATROLINK-I/II, EtherCAT, EtherNet/IP, PROFINET IO		
Data setting, input method	PC compatible software / Touch panel teaching / Teaching pendant			
Data retention memory	Position data and parameters are saved in non-volatile memory. (No limit to rewrite)			
Operation mode	Positioner mode / Pulse-train control mode (selectable by parameter setting)			
Number of positioner-mode positions	Up to 512 points for positioner type or up to 768 points for network type *The total number of positioning points varies depending on which PIO pattern is selected.			
Pulse-train interface	Input pulses	Differential type (line-driver type): 200kpps max., cable length up to 10m		
		Open-collector type: Not supported. * If the host uses open-collector outputs, use AK-04 (optional, sold separately) to change them to differential outputs.		
		Command pulse magnification (Electronic gear: A/B)	1/50 < A/B < 50/1 Setting range of A and B (set by parameters): 1~4096	
Feedback pulse output	None			
Insulation resistance	Not less than 10mΩ at DC500V			
Electric shock protection mechanism	Class I, basic insulation			
Mass (Note 3)	Incremental specification	Screw fixing type: Not more than 250g / DIN rail mounting type: Not more than 285g	Screw fixing type: Not more than 270g / DIN rail mounting type: Not more than 305g	
	Simple absolute specification (including 190g for battery)	Screw fixing type: Not more than 450g / DIN rail mounting type: Not more than 485g		
Cooling method	Natural air cooling		Forced air cooling	
Environment	Ambient operating temperature	0~40°C		
	Ambient operating humidity	Not more than 85% RH (non-condensing)		
	Operating ambience	Free from corrosive gases		
	Degree of protection	IP20		

Note 1) 0.3A higher for the field network specification.

Note 2) Rush current flows for approx. 5msec after the power is input (at 40°C). Please note that the rush current value varies depending on the impedance of the power line.

Note 3) 30g heavier for the field network specification.

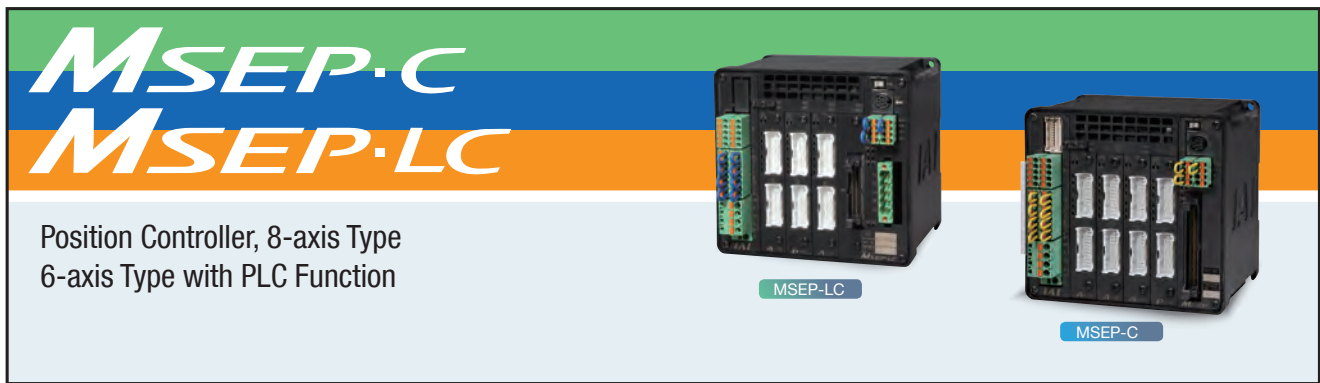

1 Adding the PLC Function

MSEP-LC

This function makes it possible to operate actuators using a ladder logic program, and to control the state of I/O (Input/Output) signals. If your system is small enough, it can be controlled using only the MSEP-LC. In a large scale system an MSEP-LC can perform distributed control of each process and reduce the load of a main PLC. In addition, it can also simplify your program and make troubleshooting easier.

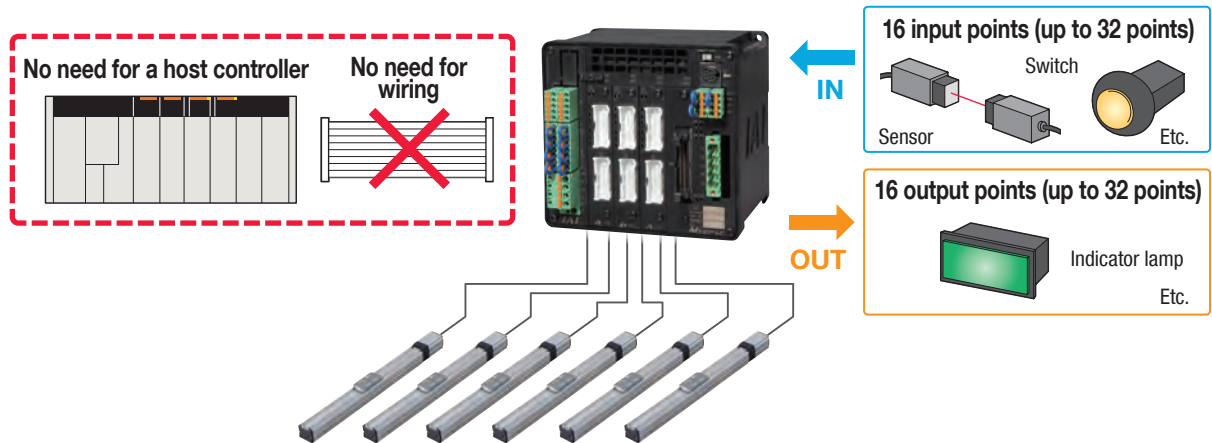

2 Supporting Actuators with the Battery-less Absolute Encoder

MSEP-LC

MSEP-C

Features of actuators with the battery-less absolute encoder

- 1 Home return is no longer necessary, so these actuators start and restart quicker than incremental actuators to begin working right away. They are also free from problems relating to home return, such as position shift.
- 2 Compared to standard absolute actuators, no battery is required, which results in the following benefits:
 - ▶ No need to purchase or replace batteries
 - ▶ No need to control the stocks and replacement timing of batteries
 - ▶ No need to make adjustment (absolute reset) normally required after battery replacement

ROBO Cylinder with the battery-less absolute encoder

RCP5



3 Supporting the PowerCON (High-output Driver) and Mini Cylinder

MSEP-LC MSEP-C

When the PowerCON (newly developed high-output driver) is installed and combined with the RCP5 or RCP4, it has achieved a 1.5 times faster maximum speed as well as double the payload compared to the conventional models. In addition, the ultra-small Mini Cylinders are also supported, giving you a greater variety of actuators--ranging from small to large--to choose from.

Maximum speed vs. conventional models
1.5 times faster

Payload vs. conventional models
more than Double

PowerCON supported
RCP5-SA RCP5-RA

Mini Cylinder
RCD-RA

Choice of 6 boards to install

- 1 Pulse motor board
- NEW** 2 Pulse motor board for battery-less absolute specification
- NEW** 3 PowerCON (pulse high-output motor) board
- NEW** 4 PowerCON board for battery-less absolute specification
- 5 AC servo motor board
- NEW** 6 Mini Cylinder (DC servo motor) board

* Boards 3 and 4 permit operation of only one axis per board.

4 Compatible Field Networks

MSEP-LC MSEP-C

DeviceNet, CC-Link, PROFIBUS-DP, CompoNet, EtherCAT, EtherNet/IP, PROFINET IO and other major field networks are directly accessible.

Features of the network specification

- ▶ 256 positioning points per axis
- ▶ Can be operated by inputting values for target positions and speed
- ▶ Monitor the current position in real time
- ▶ Substantially shorter communications time inside the controller (approx. one-tenth of conventional models)



5 Free Ladder Logic Support Software Is Available from Our Website

MSEP-LC

Ladder logic support software is available for free download from our website. You can create a ladder program before purchasing any product.

Free www.intelligentactuator.com/lc-ladder/

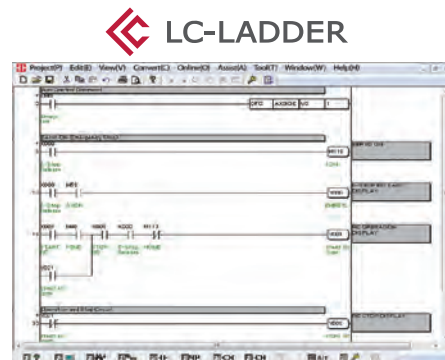

Application Examples

Rear Panel Positioning System

Work parts that have shifted can be realigned during the processing stage of an automotive rear panel by corrective "pushing" by the ROBO Cylinder. Even when the number of axes increases, a single controller can support them all, making wiring simple.

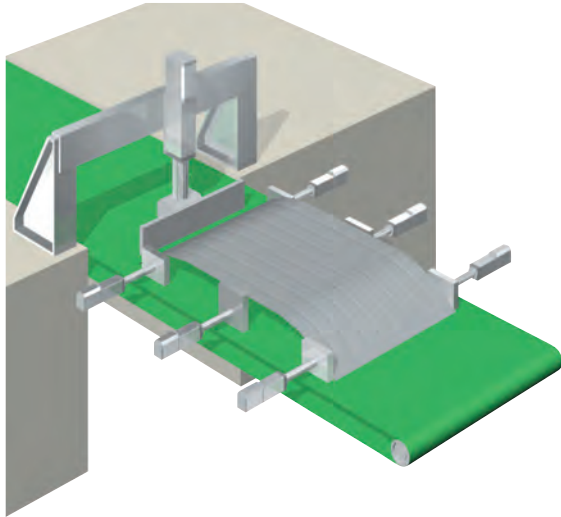

Palletizing System

Thanks to the battery-less absolute encoder, operations can easily be resumed even after an emergency stop or other halts in operation.

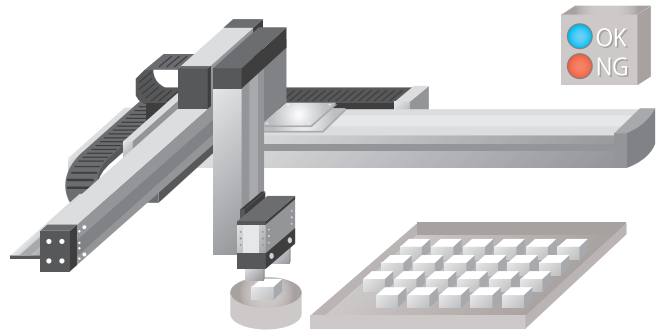

Work Transfer Between Processing Systems

Work parts can be transferred between systems without using a dedicated PLC.

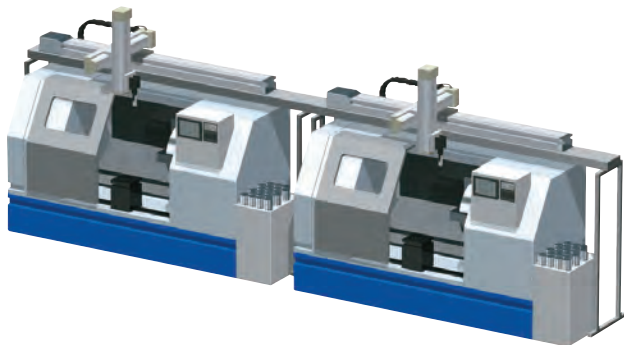

Positioning for Automotive Assembly Lines

In a large-scale assembly line, implementing distributed control of each process and connecting to the host controller via a field network will reduce the load of the host controller.

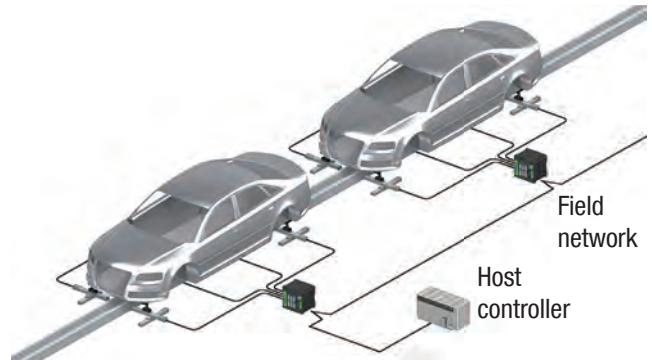

MSEP Controller Models

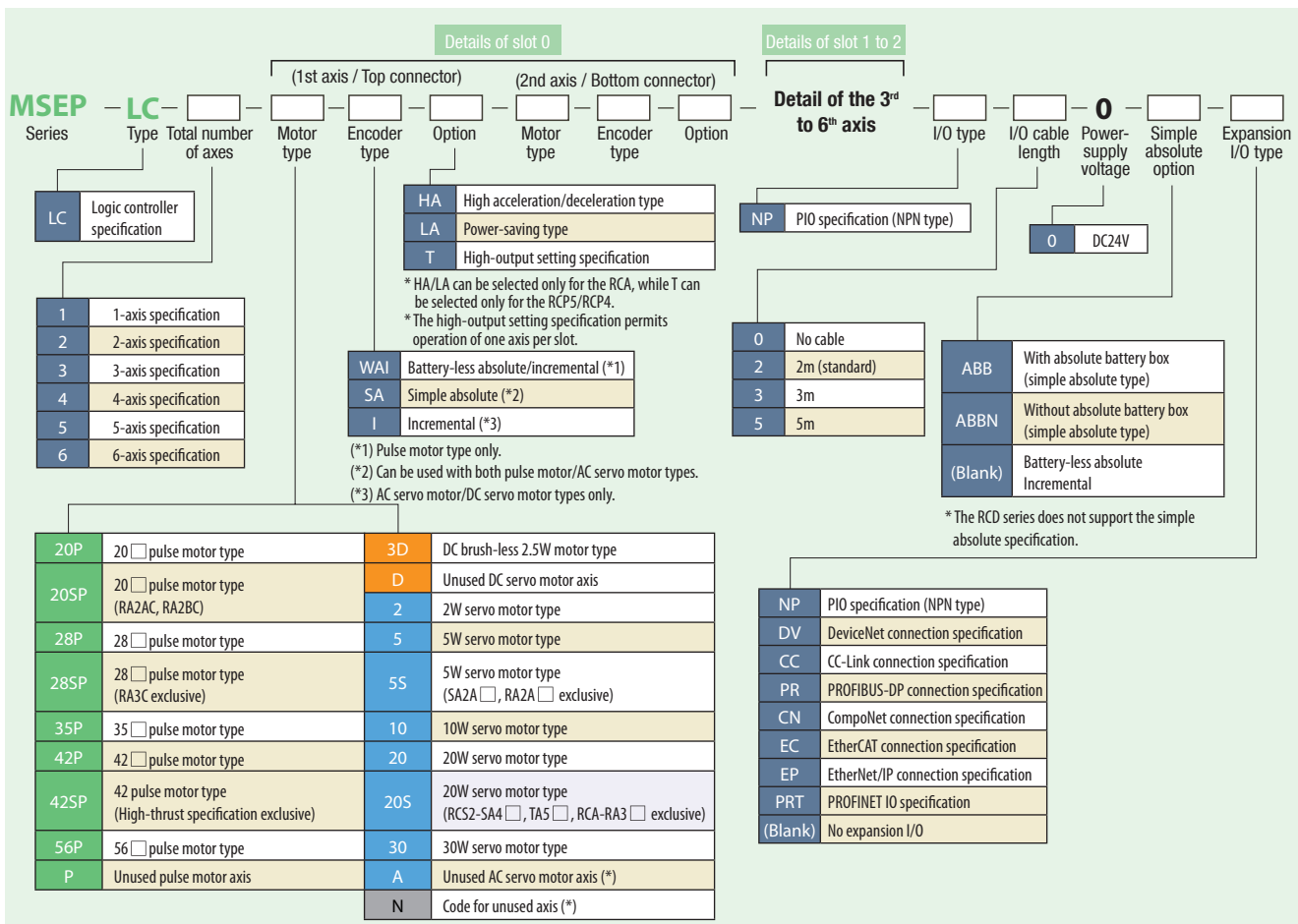
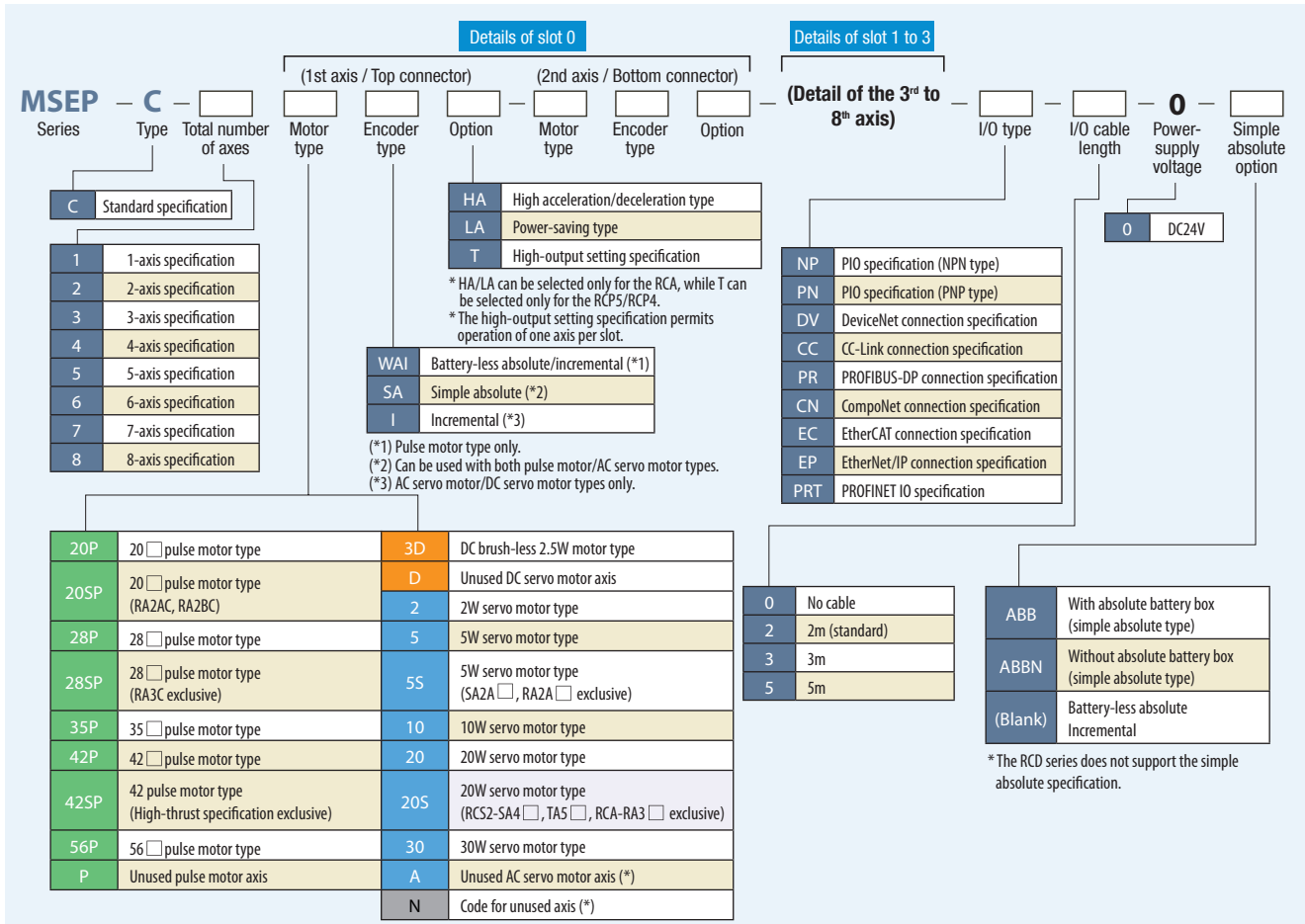

How to Operate the MSEP-C

PIO Specification

Please enter the position data into the MSEP, and designate the position number from the host PLC via PIO in order to operate the actuator.

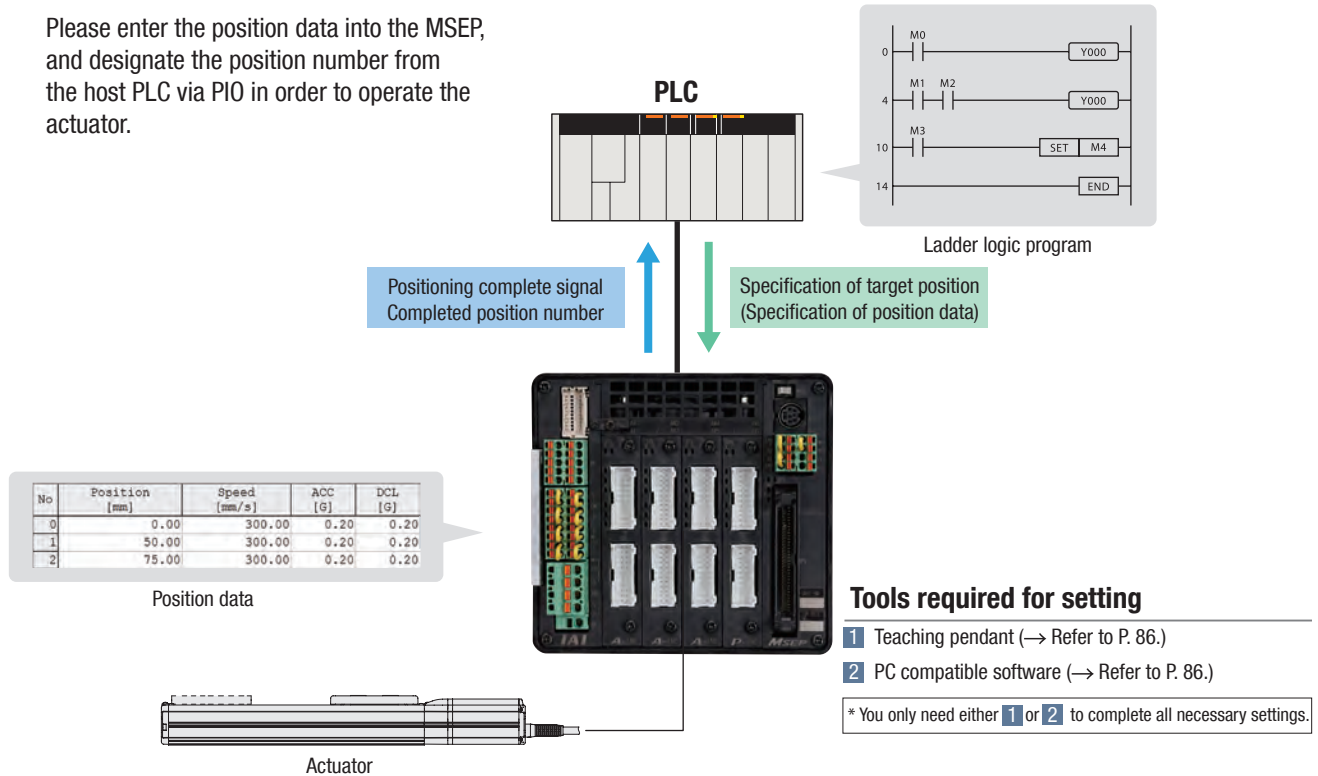

Field Network Specification

- Similarly to the PIO specification, please enter the position data into the MSEP, and designate the position number from the host PLC via a field network in order to operate the actuator.
- The PLC sends numerical position, speed and other data via a field network to operate the actuator.

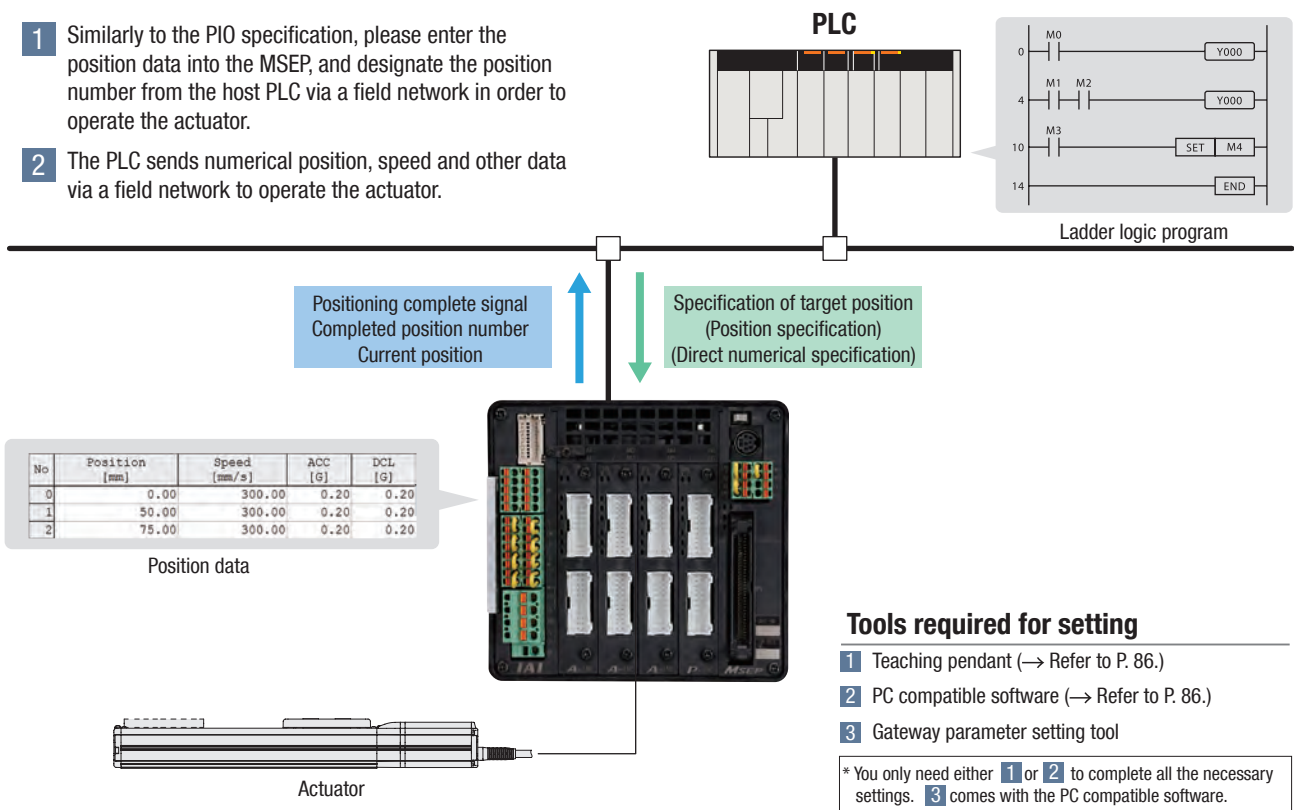

How to Operate the MSEP-LC

PIO Specification

The MSEP-LC runs a ladder logic program internally to operate the axis and control the PIO I/O signals. The axis can be operated either by using position data or specifying coordinates directly.

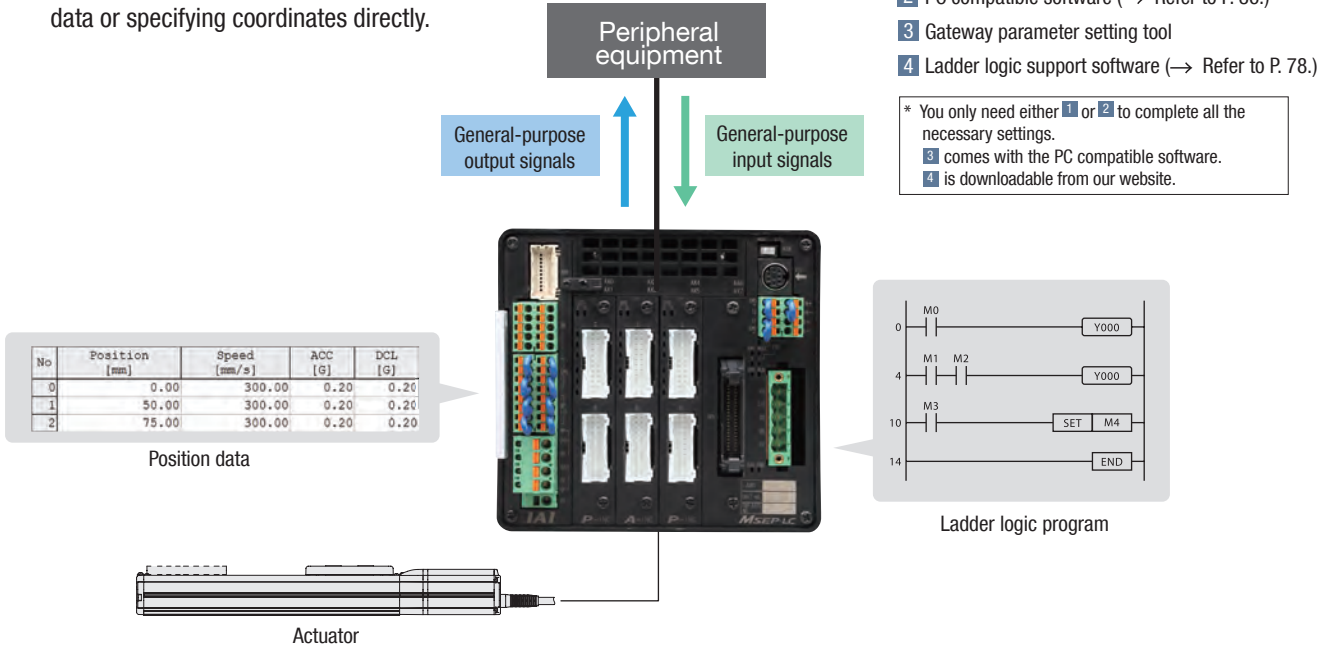

Tools required for setting

- 1 Teaching pendant (→ Refer to P. 86.)
- 2 PC compatible software (→ Refer to P. 86.)
- 3 Gateway parameter setting tool
- 4 Ladder logic support software (→ Refer to P. 78.)

* You only need either **1** or **2** to complete all the necessary settings.
3 comes with the PC compatible software.
4 is downloadable from our website.

Field Network Specification

The MSEP-LC runs a ladder logic program internally to operate the axis and control I/O signals via a network. The axis can be operated either by using position data or specifying coordinates directly.

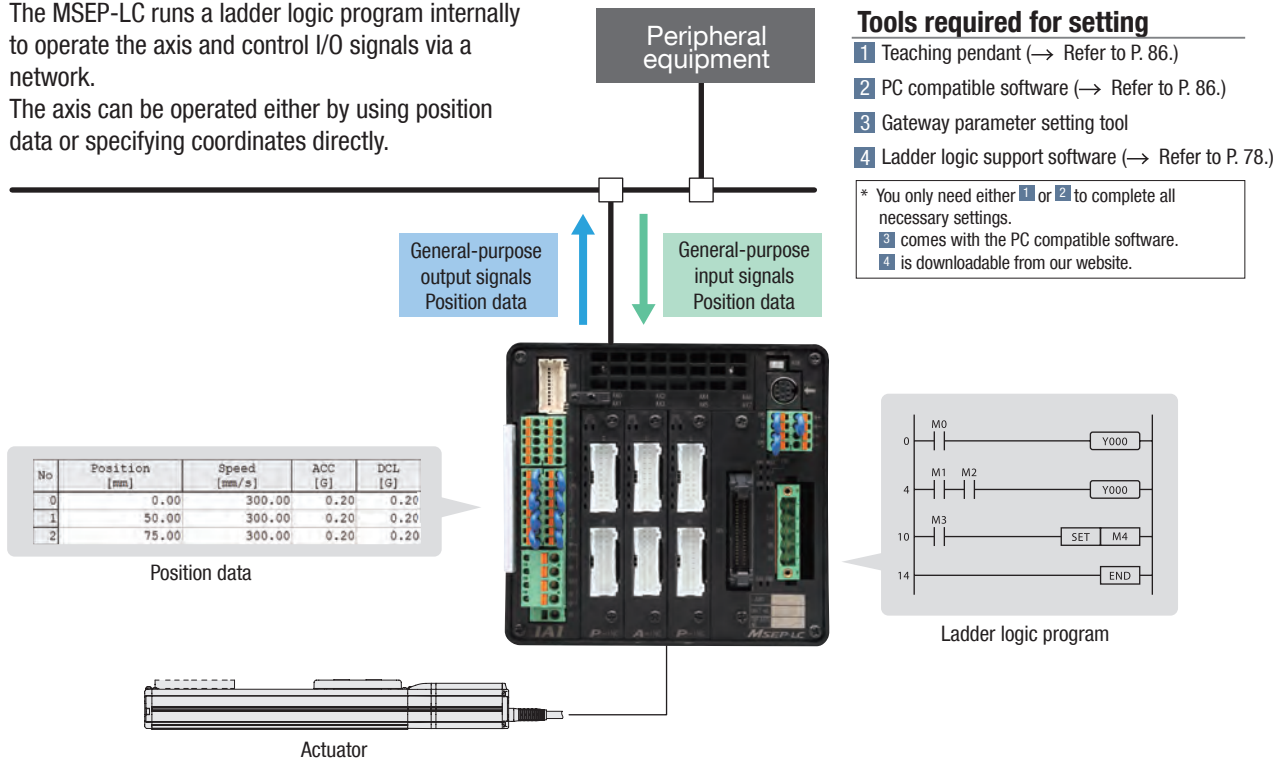

Tools required for setting

- 1 Teaching pendant (→ Refer to P. 86.)
- 2 PC compatible software (→ Refer to P. 86.)
- 3 Gateway parameter setting tool
- 4 Ladder logic support software (→ Refer to P. 78.)

* You only need either **1** or **2** to complete all the necessary settings.
3 comes with the PC compatible software.
4 is downloadable from our website.

Names of the MSEP Controller Components

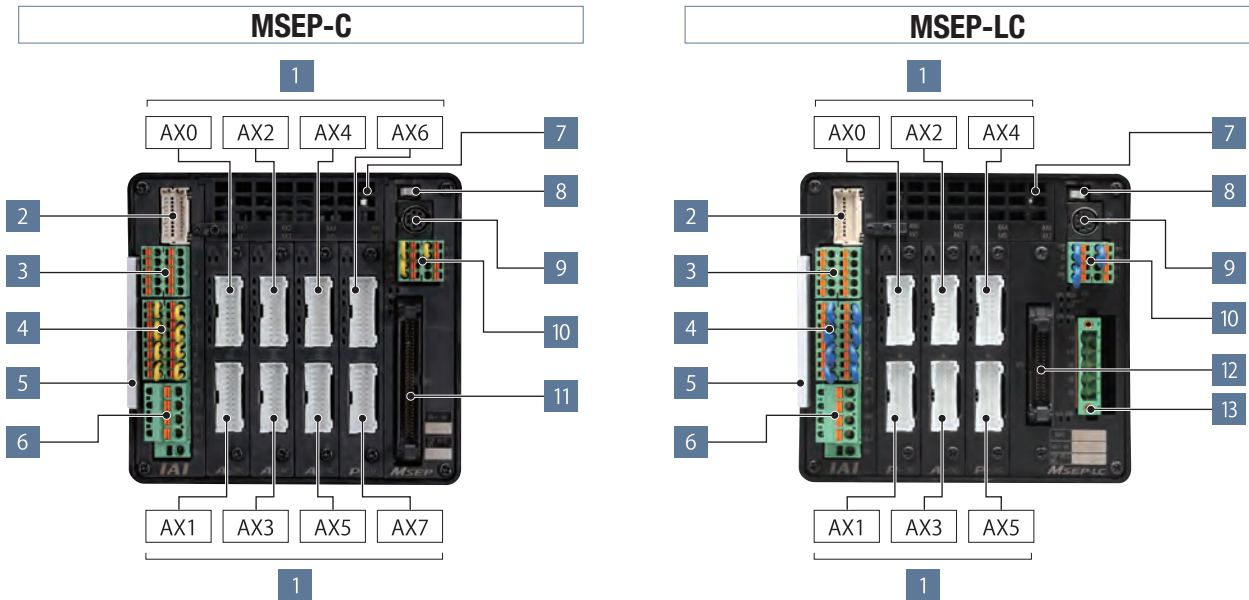

⚠ Caution: With the high-output setting specification (PowerCON), only one axis can be connected per slot.

Descriptions of Each Component

- 1 Motor-encoder connectors (Actuator connection)**
These connect the motor-encoder cables to the actuators.
- 2 Connector for the absolute data backup battery**
This connects the absolute data backup battery box should the controller be the simple absolute type.
- 3 Connector for the external brake input**
This signal input connector is used to release the actuator brake externally.
- 4 Emergency stop input connector (Power source shut-off)**
This emergency stop input connector is for input/output terminals of the motor drive shut-off external relay as well as each driver slot (*).
- 5 Information card for configuration of the connecting axes**
The information card contains information regarding the configuration of the controller axes which is removable to examine the contents.
- 6 +24 V power source input connector**
This is the main power source connector for the controller: Motor drive shut-off is possible while restoring power to the controller unit after an emergency stop. This is because the power source terminals for the motor and the controller are separate.
- 7 Fan unit**
Easily replaceable fan unit. (Replacement fan unit: Model MSEP-FU)
- 8 AUTO/MANUAL switch**
To switch automatic operation to/from manual operation
- 9 SIO connector**
To connect teaching box and the connecting cable for PC software
- 10 System I/O connector**
The connector for remote AUTO/MANU switch input and emergency stop input for the entire controller with functions including an external regeneration-resistance expansion terminal.
- 11 PIO connector/field network connector (MSEP-C only)**
The PIO specification - connects to a 68-pin ribbon I/O cable.
The field network specification - connects to a field network type specified on the MSEP controller.
- 12 Standard I/Os (MSEP-LC only)**
The MSEP-LC comes installed with a 40-pin PIO connector as standard equipment.
- 13 Expansion I/Os (MSEP-LC only)**
Expansion I/Os can be installed as an option.
Available I/O types include PIO, DeviceNet, CC-Link, PROFIBUS-DP, CompoNet, Ethernet/IP and EtherCAT.

(*) This feature is available on a single slot (two axes) basis. Please note that it is not available on a single axis basis.

Input/Output (PIO) Signals

The MSEP-C has dedicated inputs and outputs set to PIO signals at 32 input points/32 output points. The axis operates when each signal is turned ON/OFF from the host PLC.

With the MSEP-LC, general-purpose input/output signals at 32 input points/32 output points can be used in a ladder logic program by using the standard 16 input points/16 output points plus expansion I/Os.

MSEP-C (PIO specification)

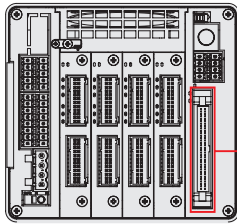

PIO connector

MSEP-LC (Expansion I/O specification)

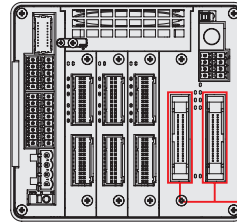

PIO connectors

PIO Wiring Diagram for MSEP-C

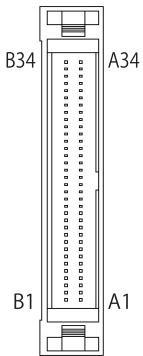

Connector name: HIF6-68PA-1.27DS (Hirose Electric)					
Pin No.	Category	Signal ID	Pin No.	Category	Signal ID
A1	24V	For I/O	A18		OUT0
A2		IN0	A19	Output (Axis No. 0)	OUT1
A3	Input (Axis No. 0)	IN1	A20		OUT2
A4		IN2	A21		OUT3
A5		IN3	A22		OUT4
A6	Input (Axis No. 1)	IN4	A23	Output (Axis No. 1)	OUT5
A7		IN5	A24		OUT6
A8		IN6	A25		OUT7
A9		IN7	A26		OUT8
A10	Input (Axis No. 2)	IN8	A27	Output (Axis No. 2)	OUT9
A11		IN9	A28		OUT10
A12		IN10	A29		OUT11
A13		IN11	A30		OUT12
A14	Input (Axis No. 3)	IN12	A31	Output (Axis No. 3)	OUT13
A15		IN13	A32		OUT14
A16		IN14	A33		OUT15
A17		IN15	A34	0V	For I/O

Connector name: HIF6-68PA-1.27DS (Hirose Electric)					
Pin No.	Category	Signal ID	Pin No.	Category	Signal ID
B1	24V	For I/O	B18		OUT16
B2		IN16	B19	Output (Axis No. 4)	OUT17
B3	Input (Axis No. 4)	IN17	B20		OUT18
B4		IN18	B21		OUT19
B5		IN19	B22		OUT20
B6	Input (Axis No. 5)	IN20	B23	Output (Axis No. 5)	OUT21
B7		IN21	B24		OUT22
B8		IN22	B25		OUT23
B9		IN23	B26		OUT24
B10	Input (Axis No. 6)	IN24	B27	Output (Axis No. 6)	OUT25
B11		IN25	B28		OUT26
B12		IN26	B29		OUT27
B13		IN27	B30		OUT28
B14	Input (Axis No. 7)	IN28	B31	Output (Axis No. 7)	OUT29
B15		IN29	B32		OUT30
B16		IN30	B33		OUT31
B17		IN31	B34	0V	For I/O

PIO Wiring Diagram for MSEP-LC

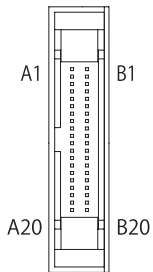

Standard I/Os

Pin No.	Category	Assigned memory	Pin No.	Category	Assigned memory
A1	-	+24V external input	A11	Input	X006
A2		Not used	A12		X007
A3		Not used	A13		X008
A4	Input	X000	A14	X009	
A5		X001	A15	X00A	
A6		X002	A16	X00B	
A7		X003	A17	X00C	
A8		X004	A18	X00D	
A9		X005	A19	X00E	
A10			A20	X00F	

Pin No.	Category	Assigned memory	Pin No.	Category	Assigned memory
B1	Output	Y000	B11	Output	Y00A
B2		Y001	B12		Y00B
B3		Y002	B13		Y00C
B4		Y003	B14		Y00D
B5		Y004	B15		Y00E
B6		Y005	B16		Y00F
B7		Y006	B17		Not used
B8		Y007	B18		Not used
B9		Y008	B19		0V external input
B10	Y009	B20			

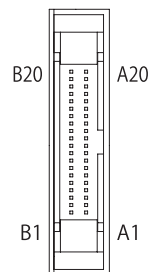

Expansion I/Os

Pin No.	Category	Assigned memory	Pin No.	Category	Assigned memory
A1	-	+24V external input	A11	Input	X016
A2		Not used	A12		X017
A3		Not used	A13		X018
A4	Input	X010	A14	X019	
A5		X011	A15	X01A	
A6		X012	A16	X01B	
A7		X013	A17	X01C	
A8		X014	A18	X01D	
A9		X015	A19	X01E	
A10			A20	X01F	

Pin No.	Category	Assigned memory	Pin No.	Category	Assigned memory
B1	Output	Y010	B11	Output	Y01A
B2		Y011	B12		Y01B
B3		Y012	B13		Y01C
B4		Y013	B14		Y01D
B5		Y014	B15		Y01E
B6		Y015	B16		Y01F
B7		Y016	B17		Not used
B8		Y017	B18		Not used
B9		Y018	B19		0V external input
B10	Y019	B20			

Table of General Specifications

Specification item		Description					
Number of axes in the controller		8 axes max. (MSEP-C), 6 axes max. (MSEP-LC)					
Controller/ Motor input power-supply voltage		DC24V ±10%					
Brake current		0.15A x Number of axes					
Current consumption by control power		0.8A					
Controller inrush current		5A max. 30ms or less					
Motor consumption current	Servo motor type	Rated ampere	Maximum		Pulse motor type	Rated ampere	Maximum
			Energy saver	Standard/Hi-accel./decel.			
	2W	0.8A		4.6A	20P		1.0A
	3W (RCD)	0.7A		1.5A	28P		1.0A
					28SP		1.2A
	5W	1.0A		6.4A	35P		2.0 A (High-output incompatible driver)
	10W (RCL)	1.3A		6.4A			
	10W (RCA/RCA2)		2.5A	4.4A	42P	2.2 A (High-output disabled)	2.2 A (High-output disabled)
20W	1.3A	2.5A	4.4A	56P		3.5 A (High-output enabled)	4.2 A (High-output enabled)
20W (20S type)	1.7A	3.4A	5.1A				
30W	1.3A	2.2A	4.4A				
Motor inrush current		Slot numbers x 10A max., under 5ms					
Motor-encoder cable length		20m max. *when the simple absolute is chosen, 10m will be the maximum length.					
Serial communication (SIO port: teaching only)		RS485 1ch (Modbus protocol compatible) Speed 9.6~230.4kbps					
External interface	PIO specification	PIO specification : DC24V dedicated signal in/output; Maximum input of 4 points/axis; Maximum output of 4 points/axis; Maximum cable length 10m					
	Field network specification	DeviceNet, CC-Link, PROFIBUS-DP, CompoNet, EtherCAT, EtherNet/IP (*)					
Data configuration and input method		PC compatible software / Touch panel teaching / Gateway parameter setting tool					
Data retention memory		Restore the position data and parameter in non-volatile memory (No limit to rewrite)					
Positioning points		PIO specification: 2 or 3 points Field network specification: 256 points (no limited input for the simple numerical control and the direct numerical control) (Note) The number of designated positions vary depending on the parameter configuration with motion mode selection.					
LED display (On the front panel)		LED for driver status, 8 LEDs (for each driver board) Status LED, 4 LEDs (PIO specification), 7 LEDs (Fieldbus specification)					
Electromagnetic brake force release		Enable to force-release by transmitting a deactivation signal to each axis (DC24 V input).					
Surge protection		Overcurrent protection (A cut-off semiconductor circuit is built-in on each slot)					
Electric shock protection		Class I basic insulation					
Insulation resistance		DC500V 10mΩ					
Mass		620g / 690g when the simple absolute spec. is selected / 1950g when used with the absolute battery box (8-axis specification)					
Cooling method		Forced air cooling					
Ambient operating temperature/humidity		0~40°C, not more than 85% RH (non-condensing)					
IP Code		IP20					
PLC function (*MSEP-LC)		Dedicated ladder program (Program capacity: 4k steps)					

Exterior Dimensions

Controller (The same dimensions apply to the MSEP-C/LC.)

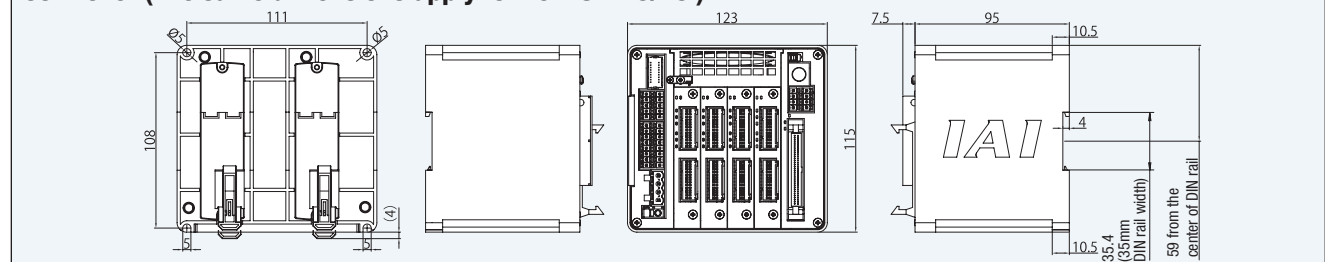

Absolute data backup battery box

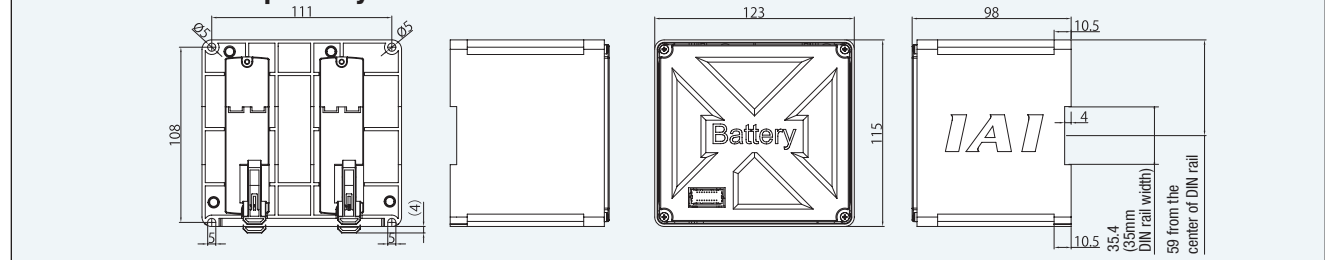

Options

Teaching pendant

Summary Teaching device for positioning input, test operation, and monitoring.

Model **TB-01-C**

Setting



Specifications

Rated voltage	DC24V
Power consumption	3.6W or less (150mA or less)
Ambient operating temperature	0~50°C°
Ambient operating humidity	20~85% HR (non-condensing)
Environmental resistance	IP40 (initial state)
Weight	507g (TB-01 unit only)

PC compatible software (Windows only)* For the MSEP field network specification, the PC software is required.

Summary A startup support software for inputting positions, performing test runs, and monitoring. With enhancements for adjustment functions, the startup time is shortened.

Model **RCM-101-MW** External device communication cable and RS232 conversion unit included)

Setting

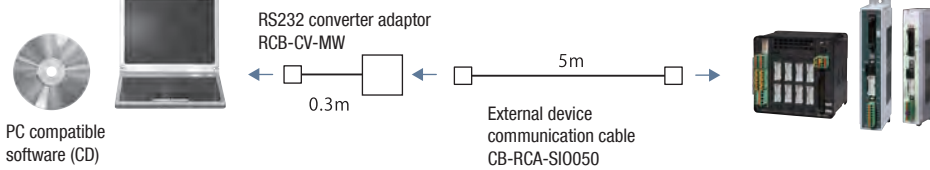

Supported Windows: 2000 SP4 or later / XP SP2 or later / Vista / 7 / 8



Model **RCM-101-USB** (External device communication cable, USB converter adaptor, and USB cable included)

Setting

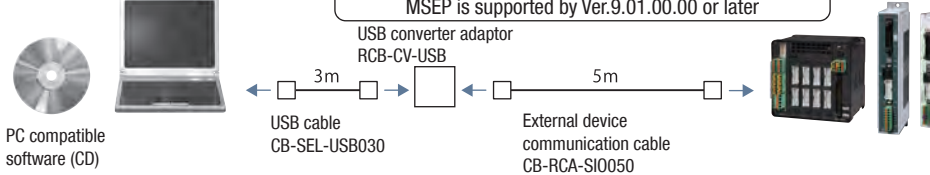

External regeneration resistor

Summary As the motor reduces its speed, the resistor will convert dissipated regenerative current into heat. Since the MSEP controller has a built-in regeneration resistor, this can be used for normal operations. However, an external resistor can be installed should the capacity of the internal resistor be insufficient.

Model **RER-1**

Exterior dimensions

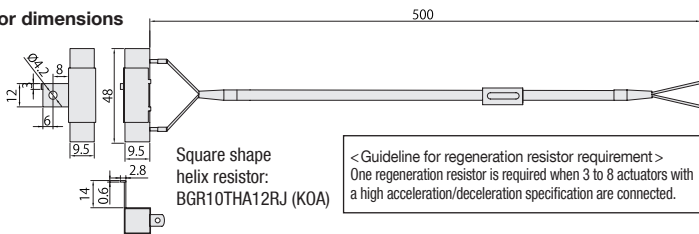

Driver board

Summary The driver board can be supplemented or exchanged in the MSEP controller. When just the actuator operated needs to be modified, this can be done by simply replacing the driver board instead of the entire controller. (The parameters will need to be adjusted when the driver board is replaced)

Model / Standard price

Motor type	High output type	Encoder type	Number of axes	Model	Standard price
Pulse motor	High-output setting enabled	Battery-less absolute/incremental	1	MSEP-PPD1-W	—
		Simple absolute	1	MSEP-PPD1-A	—
		Battery-less absolute/incremental	1	MSEP-PD1-W	—
	High-output setting disabled	Battery-less absolute/incremental	2	MSEP-PD2-W	—
		Simple absolute	1	MSEP-PD1-A	—
		Simple absolute	2	MSEP-PD2-A	—
AC servo motor	—	Incremental	1	MSEP-AD1-I	—
		Incremental	2	MSEP-AD2-I	—
	—	Simple absolute	1	MSEP-AD1-A	—
		Simple absolute	2	MSEP-AD2-A	—
DC servo motor	—	Incremental	1	MSEP-DD1-I	—
			2	MSEP-DD2-I	—

Absolute data backup battery box

Summary If the absolute position encoder specification is selected with code ABB, the absolute data backup battery box is included with the controller. However, if the battery box is ordered as a separate unit, it does not include the battery but just the box itself. If the battery is needed, please purchase it separately. (Model: AB-7).

Model **MSEP-ABB** (Batteries not included)

Exterior dimensions See P.85

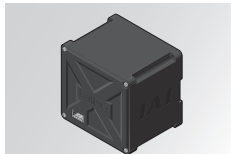

* A cable (Model CB-MSEP-AB005) that connects the absolute data backup battery box to the MSEP is included with the box.

Replacement battery

Summary The replacement battery for the absolute data backup battery box.

Model **AB-7**



Replacement fan unit

Model **MSEP-FU**

MSEL



Multi-axis Program Controller for the ROBO Cylinder

Introducing MSEL, the Multi-axis Program Controller with a High-output Driver (PowerCON) for the ROBO Cylinder

1 The Pulse Motor Equipped ROBO Cylinder Controls a Maximum of 4 Axes

Traditionally, up to two pulse motor actuators could be controlled by a program controller. By using MSEL, a maximum of 4 axes can be controlled. Interpolation function is also available, enhancing its range of use.

Example of Combinations

3-axis Cartesian (Pulse Motor)

RCP5

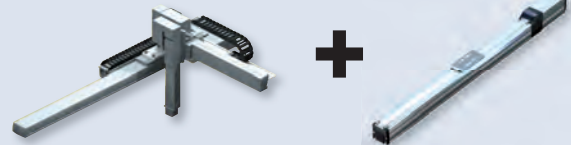

A Maximum of 4 Axes Can Be Connected

2 The ROBO Cylinders RCP5 and RCP4 Can be Connected

PowerCON drivers make it possible to perform interpolation functions using the high-output RCP5 and RCP4 Robo Cylinders, which could not be performed with the traditional PSEL program controller.



3 Significant Enhancements in Programming Functions

Compared to the conventional product (PSEL), we have enhanced the functionality of the MSEL by having 4 times as many programs and 20 times more positions.

	Conventional product PSEL		New product MSEL
Number of programs	64	4 times →	255
Number of program steps	2,000	5 times →	9,999
Number of multi-tasking programs	8	2 times →	16
Number of positions	1,500	20 times →	30,000 (*1)

(*1) Note that the number of points available for backup in system memory is 10,000 points.

4

Equipped with an Optional Expansion I/O Slot

In addition to the standard I/O (IN 16 points/OUT 16 points), an expansion I/O slot can be filled with either a PIO board (IN 16 points/OUT 16 points) or one of four types of field networks.

	Conventional Product PSEL	New Product MSEL
Max. I/O Input and Output Points	24/8 Not applicable for expansion	32/32 When the expandable slot is used
Field Network	3 types (CC-Link, DeviceNet, PROFIBUS-DP)	4 types (CC-Link, DeviceNet, PROFIBUS-DP, EtherNet/IP)
Other External Connections	RS232C: 1ch	RS232C: 1ch

5

Cable and Cost Reduction

When Controlling 4 Actuator Axes

Conventional Product PSEL 2 units + PS241 (24V power supply)

New Product MSEL 1 unit

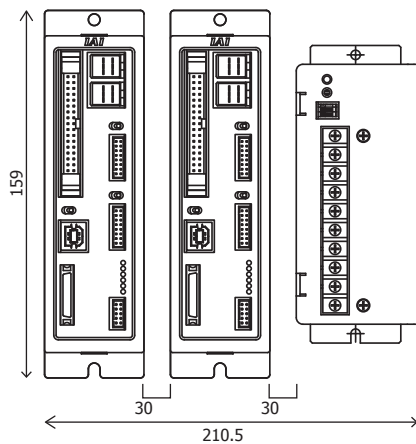

Cable Reduction
The built-in power source is compatible to AC100-230V
Cost Reduction
Approx. **36%** reduced

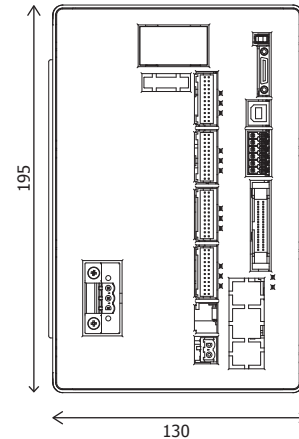

6

Introducing the Safety Category Compatible Type to the Lineup (For Category 3)

The MSEL-PG is compatible with safety category 3.

(In order to function with the safety category, you must first install an external safety circuit for the controller)

7

Compatible with Various Models

The MSEL can be connected to a range of pulse motor type ROBO Cylinders including RCP5/RCP4/RCP3/RCP2.



Service Parts

Model Number	CB-CAN-MPA <input type="checkbox"/> <input type="checkbox"/> <input type="checkbox"/> <input type="checkbox"/>	Standard Motor-Encoder Cable	for
Model Number	CB-CAN-MPA <input type="checkbox"/> <input type="checkbox"/> <input type="checkbox"/> <input type="checkbox"/> -RB	Integrated Motor-Encoder Robot Cable	RCP5/RCD

* Please indicate cable length (L) in , maximum 20m, e.g.) 080 = 8m

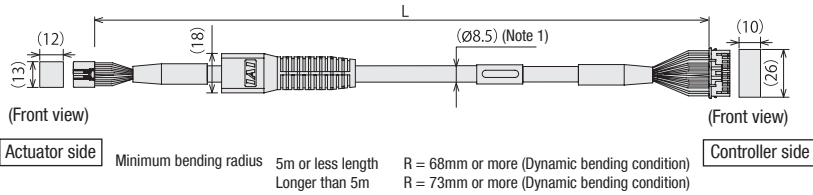

* The robot cable is designed for flex-resistance: Please use the robot cable if the cable has to be installed through the cable track.

(Note 1) If the cable is 5m or longer, Ø9.1 cable diameter applies for a non-robot cable and Ø10 for a robot cable.

Pin No	Signal name	Pin No	Signal name
3	ØA	1	ØA
5	VMM	2	VMM
10	ØB	3	ØB
9	VMM	4	VMM
4	ØA	5	ØA
15	ØB	6	ØB
8	LS+	7	LS+
14	LS-	8	LS-
12	SA(mABS)	11	SA(mABS)
17	SB(mABS)	12	SB(mABS)
1	A+	13	A+
6	A-	14	A-
11	B+	15	B+
16	B-	16	B-
20	BK+	9	BK+
2	BK-	10	BK-
21	VCC	17	VCC
7	GND	19	GND
18	VPS	18	VPS
13	LS_GND	20	LS_GND
19	—	22	—
22	—(CFVcc)	21	—(CFVcc)
23	—	23	—
24	FG	24	FG

Model Number	CB-CFA3-MPA <input type="checkbox"/> <input type="checkbox"/> <input type="checkbox"/> <input type="checkbox"/>	Standard Motor-Encoder Cable	for
Model Number	CB-CFA3-MPA <input type="checkbox"/> <input type="checkbox"/> <input type="checkbox"/> <input type="checkbox"/> -RB	Integrated Motor-Encoder Robot Cable	RCP5-RA8C/8R/10C/10R

* Please indicate cable length (L) in , maximum 20m, e.g.) 080 = 8m

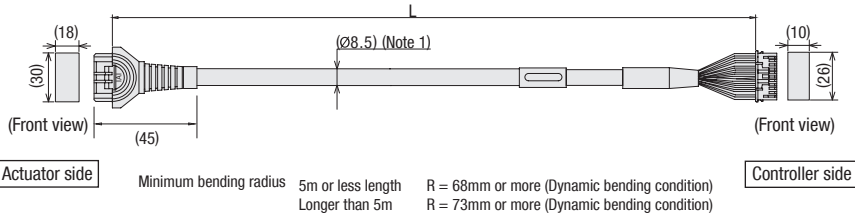

* The robot cable is designed for flex-resistance: Please use the robot cable if the cable has to be installed through the cable track.

(Note 1) If the cable is 5m or longer, Ø9.1 cable diameter applies for a non-robot cable and Ø10 for a robot cable.

Pin No	Signal name	Pin No	Signal name
A1	ØA	1	ØA
B1	VMM	2	VMM
A2	ØA	5	ØA
B2	ØB	3	ØB
A3	VMM	4	VMM
B3	ØB	6	ØB
A4	LS+	7	LS+
B4	LS-	8	LS-
A6	SA(mABS)	11	SA(mABS)
B6	SB(mABS)	12	SB(mABS)
A7	A+	13	A+
B7	A-	14	A-
A8	B+	15	B+
B8	B-	16	B-
A5	BK+	9	BK+
B5	BK-	10	BK-
A9	LS_GND	20	LS_GND
B9	VPS	18	VPS
A10	VCC	21	VCC
B10	GND	19	GND
A11	—	17	—
B11	FG	22	—
		23	—
		24	FG

Model Number	CB-CA-MPA <input type="checkbox"/> <input type="checkbox"/> <input type="checkbox"/> <input type="checkbox"/>	Standard Motor-Encoder Cable	for
Model Number	CB-CA-MPA <input type="checkbox"/> <input type="checkbox"/> <input type="checkbox"/> <input type="checkbox"/> -RB	Integrated Motor-Encoder Robot Cable	RCP4

* Please indicate cable length (L) in , maximum 20m, e.g.) 080 = 8m

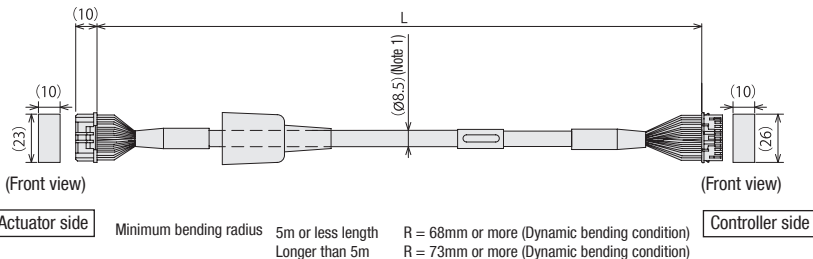

* The robot cable is designed for flex-resistance: Please use the robot cable if the cable has to be installed through the cable track.

(Note 1) If the cable is 5m or longer, Ø9.1 cable diameter applies for a non-robot cable and Ø10 for a robot cable.

Pin No	Signal name	Pin No	Signal name
A1	ØA/U	1	ØA/U
B1	VMM/V	2	VMM/V
A2	ØA/W	5	ØA/W
B2	ØB/-	3	ØB/-
A3	VMM/-	4	VMM/-
B3	ØB/+	6	ØB/+
A4	LS+/BK+	7	LS+/BK+
B4	LS-/BK-	8	LS-/BK-
A6	-/A+	11	-/A+
B6	-/A-	12	-/A-
A7	A+/B+	13	A+/B+
B7	A-/B-	14	A-/B-
A8	B+/Z+	15	B+/Z+
B8	B-/Z-	16	B-/Z-
A5	BK+/LS+	9	BK+/LS+
B5	BK-/LS-	10	BK-/LS-
A9	LS_GND	20	LS_GND
B9	VPS	18	VPS
A10	VCC	17	VCC
B10	GND	19	GND
A11	—	21	—
B11	FG	22	—
		23	—
		24	FG

Model Number	CB-APSEP-MPA <input type="checkbox"/> <input type="checkbox"/> <input type="checkbox"/> <input type="checkbox"/> -LC	Standard Motor-Encoder Cable	for
Model Number	CB-APSEP-MPA <input type="checkbox"/> <input type="checkbox"/> <input type="checkbox"/> <input type="checkbox"/>	Integrated Motor-Encoder Robot Cable	RCP3/RCA2 and others

* Please indicate cable length (L) in , maximum 20m, e.g.) 080 = 8m

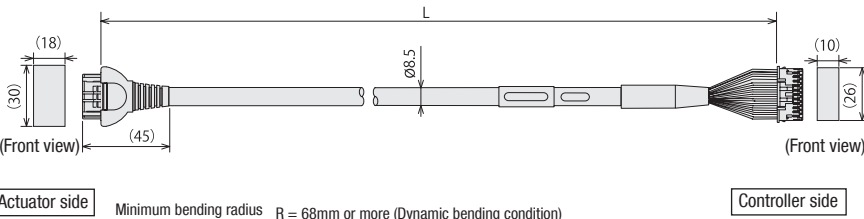

Actuator side	Pin number	Controller side	Pin number
A1	1	1	1
B1	2	2	2
A2	3	3	3
B2	4	4	4
A3	5	5	5
B3	6	6	6
A4	7	7	7
B4	8	8	8
A6	11	11	11
B6	12	12	12
A7	13	13	13
B7	14	14	14
A8	15	15	15
B8	16	16	16
A5	9	9	9
B5	10	10	10
A9	20	20	20
B9	18	18	18
A10	17	17	17
B10	19	19	19
A11	21	21	21
B11	22	22	22
	23	23	23
	24	24	24
	25	25	25

Model Number **CB-PSEP-MPA** **Integrated Motor-Encoder Robot Cable** **for RCP2**

* Please indicate cable length (L) in , maximum 20m, e.g.) 080 = 8m

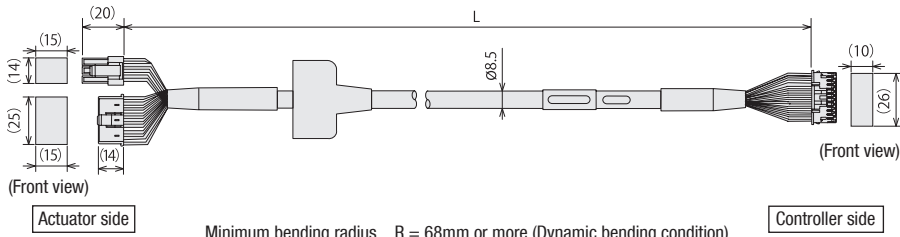

Minimum bending radius R = 68mm or more (Dynamic bending condition)

Actuator side		Controller side
Pin number		Pin number
1		1
2	(OA)	2
3	(VMM)	3
4	(OB)	4
5	(VMM)	5
6	(O/A)	6
7	(OB)	7
8	(BK+)	8
9	(BK-)	9
10	NC	10
11	NC	11
12	NC	12
13	(LS+)	13
14	(LS-)	14
15	(A+)	15
16	(A-)	16
17	(B+)	17
18	(B-)	18
19	(VCC)	19
20	(VPS)	20
21	(GND)	21
22	(Spare)	22
23	NC	23
24	NC	24
Shield [FG]		Shield [FG]

Model Number **CB-RPSEP-MPA** **Integrated Motor-Encoder Robot Cable** **for RCP2-RTBS/RTBSL/RTCS/RTCSL**

* Please indicate cable length (L) in , maximum 20m, e.g.) 080 = 8m

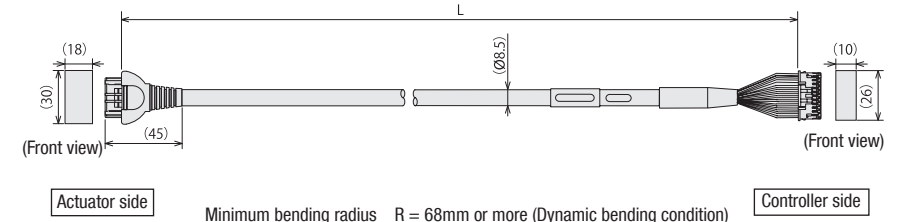

Minimum bending radius R = 68mm or more (Dynamic bending condition)

Actuator side		Controller side
Pin number		Pin number
A1	(OA)	1
B1	(VMM)	2
A2	(O/A)	3
B2	(OB)	4
A3	(VMM)	5
B3	(O/B)	6
A6	(LS+)	7
B6	(LS-)	8
A7	(A+)	9
B7	(A-)	10
A8	(B+)	11
B8	(B-)	12
A4	NC	13
B4	NC	14
A5	(BK+)	15
B5	(BK-)	16
A9	(GNDLS)	17
B9	(VPS)	18
A10	(VCC)	19
B10	(GND)	20
A11	NC	21
B11	NC	22
Shield [FG]		Shield [FG]
		NC
		NC
		NC

Model Number **CB-ASEP-MPA** **Integrated Motor-Encoder Robot Cable** **for RCA**

* Please indicate cable length (L) in , maximum 20m, e.g.) 080 = 8m

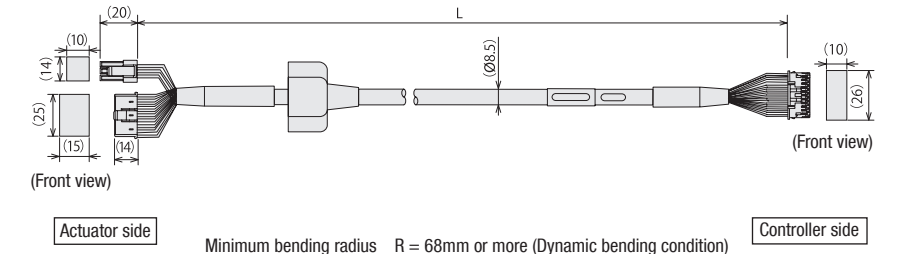

Minimum bending radius R = 68mm or more (Dynamic bending condition)

Actuator side		Controller side
Pin number		Pin number
1	(U)	1
2	(V)	2
3	NC	3
4	(W)	4
5	NC	5
6	NC	6
7	(BK+)	7
8	(BK-)	8
9	(LS+)	9
10	(LS-)	10
11	(A+)	11
12	(A-)	12
13	(B+)	13
14	(B-)	14
15	(Z+)	15
16	(Z-)	16
17	(VCC)	17
18	(VPS)	18
19	(GND)	19
20	(Spare)	20
21	NC	21
22	NC	22
23	NC	23
24	NC	24
Shield [FG]		Shield [FG]

Model Number **CB-MSEP-PIO** **PIO Flat Cable** **for MSEP-C**

* Please indicate cable length (L) in , maximum 10m, e.g.) 020 = 2m

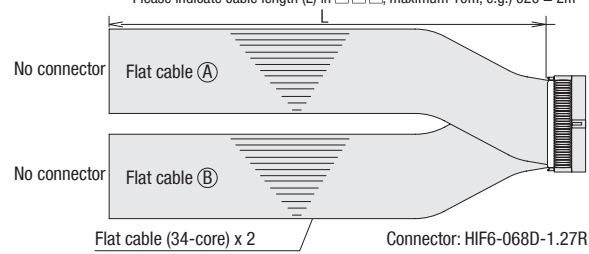

No.	Cable color	Wiring	No.	Cable color	Wiring	No.	Cable color	Wiring	No.	Cable color	Wiring
A1	Brown-1		A18	Gray-2		B1	Brown-5		B18	Gray-6	
A2	Red-1		A19	White-2		B2	Red-5		B19	White-6	
A3	Orange-1		A20	Black-2		B3	Orange-5		B20	Black-6	
A4	Yellow-1		A21	Brown-3		B4	Yellow-5		B21	Brown-7	
A5	Green-1		A22	Red-3		B5	Green-5		B22	Red-7	
A6	Blue-1		A23	Orange-3		B6	Blue-5		B23	Orange-7	
A7	Purple-1		A24	Yellow-3		B7	Purple-5		B24	Yellow-7	
A8	Gray-1		A25	Green-3		B8	Gray-5		B25	Green-7	
A9	White-1		A26	Blue-3		B9	White-5		B26	Blue-7	
A10	Black-1		A27	Purple-3		B10	Black-5		B27	Purple-7	
A11	Brown-2		A28	Gray-3		B11	Brown-6		B28	Gray-7	
A12	Red-2		A29	White-3		B12	Red-6		B29	White-7	
A13	Orange-2		A30	Black-3		B13	Orange-6		B30	Black-7	
A14	Yellow-2		A31	Brown-4		B14	Yellow-6		B31	Brown-8	
A15	Green-2		A32	Red-4		B15	Green-6		B32	Red-8	
A16	Blue-2		A33	Orange-4		B16	Blue-6		B33	Orange-8	
A17	Purple-2		A34	Yellow-4		B17	Purple-6		B34	Yellow-8	

Model Number **CB-PAC-PIO** **PIO Flat Cable** **for PCON-CA/MSEP-LC**

* Please indicate cable length (L) in , maximum 10m, e.g.) 080 = 8m

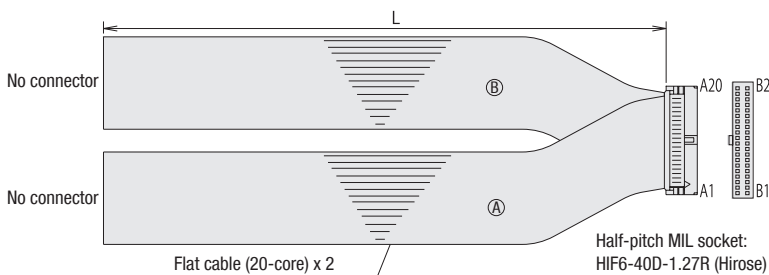

No.	Signal name	Cable color	Wiring	No.	Signal name	Cable color	Wiring
A1	24V	Brown-1		B1	OUT0	Brown-3	
A2	24V	Red-1		B2	OUT1	Red-3	
A3	—	Orange-1		B3	OUT2	Orange-3	
A4	—	Yellow-1		B4	OUT3	Yellow-3	
A5	INO	Green-1		B5	OUT4	Green-3	
A6	IN1	Blue-1		B6	OUT5	Blue-3	
A7	IN2	Purple-1		B7	OUT6	Purple-3	
A8	IN3	Gray-1		B8	OUT7	Gray-3	
A9	IN4	White-1		B9	OUT8	White-3	
A10	IN5	Black-1		B10	OUT9	Black-3	
A11	IN6	Brown-2		B11	OUT10	Brown-4	
A12	IN7	Red-2		B12	OUT11	Red-4	
A13	IN8	Orange-2		B13	OUT12	Orange-4	
A14	IN9	Yellow-2		B14	OUT13	Yellow-4	
A15	IN10	Green-2		B15	OUT14	Green-4	
A16	IN11	Blue-2		B16	OUT15	Blue-4	
A17	IN12	Purple-2		B17	—	Purple-4	
A18	IN13	Gray-2		B18	—	Gray-4	
A19	IN14	White-2		B19	0V	White-4	
A20	IN15	Black-2		B20	0V	Black-4	

IAI America, Inc.

Headquarters: 2690 W. 237th Street, Torrance, CA 90505 (800) 736-1712

Chicago Office: 110 E. State Pkwy, Schaumburg, IL 60173 (800) 944-0333

Atlanta Office: 1220 Kennestone Circle, Suite 108, Marietta, GA 30066 (888) 354-9470

www.intelligentactuator.com

The information contained in this product brochure may change without prior notice due to product improvements.

IAI Industrieroboter GmbH

Ober der R6th 4, D-65824 Schwalbach am Taunus, Germany

IAI (Shanghai) Co., Ltd.

SHANGHAI JIAHUA BUSINESS CENTER A8-303,808,
Hongqiao Rd. Shanghai 200030, China

IAI Robot (Thailand) Co., Ltd.

825 PhairojKijja Tower 12th Floor, Bangna-Trad RD.,
Bangna, Bangna, Bangkok 10260, Thailand