



Think Automation and beyond...



IDEC FT1A SmartAXIS
Value. Versatility. The New Breed of Controllers.

Design-in More Function with Affordable FT1A PLCs





Value. Versatility. The New Breed of Controller!

The ideal solution for a variety of applications.

Presenting FT1A, the newest family of SmartAXIS controllers from the industry's original manufacturer of micro PLCs. FT1A controllers deliver affordability without compromise. Features and functions are already built in, so engineers can now enjoy more versatility and more choices for their automation needs than ever before.

Designed to give you the most bang for your buck, these simple, powerful controllers deliver an exceptional value. FT1A controllers are available with 12, 24, 40, or 48 I/O, while a 3.8-inch HMI+PLC with sophisticated features and a super-bright LCD screen is also available.

All FT1A controllers meet the highest industry standards for quality and safety. The FT1A SmartAXIS family is CE compliant, cULus listed, has ABS (Certificate of Design Assessment) and is Class I Division 2 rated for hazardous locations. Whatever your application requires, the FT1A SmartAXIS family has a solution!



ABS

American Bureau of Shipping

DNV

Det Norske Veritas

LR

Lloyd's Register

NK

NIPPON KAJI KYOKAI



FT1A Touch HMI + PLC

A Breed of Its Own

The perfect combination of PLC processing and HMI monitoring and control, the 3.8-inch SmartAXIS Touch is an all-in-one touchscreen interface and logic controller. With a compact body and full complement of features, FT1A is perfect for small systems that require a graphical user interface along with versatile I/O controls at a truly affordable price.

Analog Expansion Cartridges (Transistor Output Models)

- Up to 2 analog expansion adapters can be configured on the FT1A Touch.
- Maximum combination of 2in/6out, 4in/4out, or 6in/2out analog I/O can be configured.

RS232C and RS485 ports

- Built-in RS232C, RS422/485 interface for serial communication.
- Communication with IDEC or other PLCs also supported through this serial port.

USB-A Port

Embedded USB-A port for data logging and recipe data, as well as for performing program updates.

Relay or Transistor Outputs

- Relay output type equipped with 10A contact, so no interposing relays required.
- Transistor output type equipped with 300mA per channel.

Analog Outputs (Transistor Output Models)

2 built-in 0-10VDC, 4-20mA analog outputs.

Digital, Analog and High-speed Inputs

8 built-in DC inputs

- 2 inputs (I6 and I7) can be configured as 0-10V DC analog inputs or 4-20mA analog inputs (transistor output models)
 - 10-bit resolution
- 4 high-speed counters
 - Up to 10kHz

Harsh Environments

- Class I, Division 2 for hazardous locations
- -20 to 55°C operating temperature (color models)

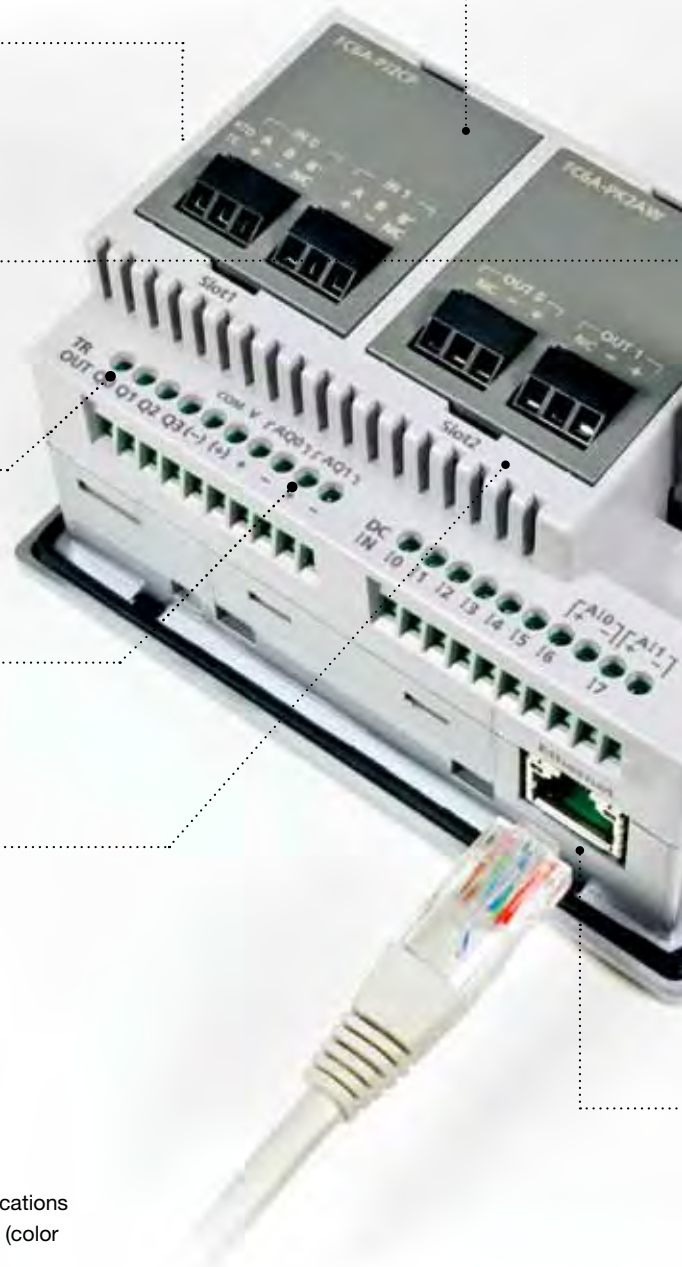

USB Mini-B

Embedded USB mini-B port for programming.

3 Bezel Colors

Available in silver, light gray and dark gray bezel.

STN Monochrome or 65K TFT Color

- 400cd/m² color
- 740cd/m² monochrome



Actual Size

IP66F (water and oil tight)
NEMA 4X (indoor) and 13

5MB Screen Editing Memory

Provides users with more flexibility and stress-free programming.

RJ45 Ethernet Port

- Supports remote Ethernet communication and Modbus TCP.
- Communication with I-DEC or other PLCs also supported through the Ethernet port.

FT1A Touch Features

Control Functions

Fast Processing Speed

Basic instructions can be processed in 1850µs per 1000 steps of programming.

Data Logging

Critical data can be saved and logged into a USB memory stick then retrieved over an Ethernet connection or by removing the USB memory stick from the FT1A Touch and inserting it into a laptop or PC.

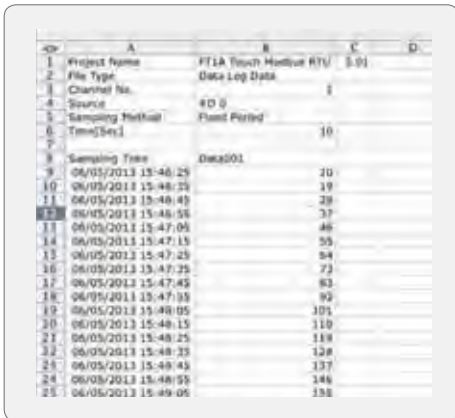

Project Name	File Type	Channel No.	Source	Sampling Method	Time[Sec]	Sampling Time
FT1A Touch Master RTU	Data Log Data	1	#D 0	Fixed Period	10	
06/05/2013 15:46:25						30
06/05/2013 15:46:35						39
06/05/2013 15:46:45						28
06/05/2013 15:46:55						37
06/05/2013 15:47:05						46
06/05/2013 15:47:15						55
06/05/2013 15:47:25						64
06/05/2013 15:47:35						72
06/05/2013 15:47:45						80
06/05/2013 15:47:55						89
06/05/2013 15:48:05						101
06/05/2013 15:48:15						110
06/05/2013 15:48:25						118
06/05/2013 15:48:35						128
06/05/2013 15:48:45						137
06/05/2013 15:48:55						146
06/05/2013 15:49:05						156

Easy Program File Transfer

Project files can be transferred between a USB memory stick and the FT1A Touch. It is a quick and convenient way for an OEM to program multiple units and for users to quickly update ladder and HMI programs.



Digital and Analog Inputs

The FT1A Touch is equipped with 8 digital inputs, two of which can be configured as 0-10V DC or 4-20mA analog inputs with 10-bit resolution, reducing overall system cost.

High-speed Counters

With 8 built-in inputs, 4 can be configured as high-speed counters, with a maximum frequency (range) of 10kHz for single-phase or 5kHz for dual-phase.

Remote I/O

Up to three FT1A controllers (24, 40 and 48 I/O) can be configured as remote I/O slaves for the FT1A Touch, expanding your system's potential. A maximum of 158 I/O can be achieved.

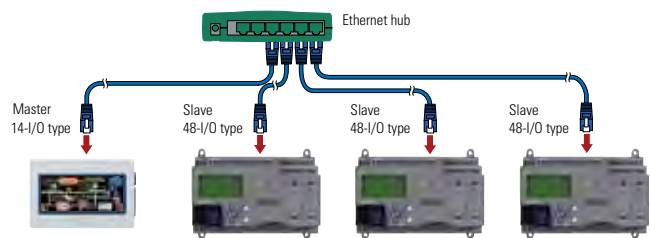

Analog Expansion Cartridges

Using analog expansion cartridges, FT1A Touch can utilize 0-10V DC, 4-20mA, RTD and Thermocouple inputs.

PID Controls

With an improved PID algorithm and easier-to-configure dialog box, PID controls can be monitored using a single screen. Advanced PID control functions, such as auto-tuning, ARW (anti-reset windup) and bumpless transfer, are also supported.

Large Programming Memory

With 47.4KB of logic controls programming, complex PLC programs can be constructed without much restriction. And with 5MB of configuration memory for the display, a unique and professional display interface can be easily configured.

10A Relay Outputs

With 10A contact ratings on all four of the relay outputs, the FT1A Touch can be directly connected to a solenoid valve or motor, which eliminates interposing relays and reduces wiring.





65,536 TFT Color LCD

With so many color combinations, an intuitive and crisp graphical user interface can be constructed with unparalleled visibility.

Super-Bright LED

The 65K TFT color unit is rated at 400cd/m², while the monochrome unit is rated at 740cd/m². With 32 levels of brightness control, the backlight can even be adjusted according to the surrounding conditions.

Drivers for IDEC and other PLCs

FT1A Touch can easily be configured to communicate with IDEC or other PLCs such as Siemens, Automation Direct, Mitsubishi, Omron, and more.

Display Functions

Ethernet Connectivity

With the embedded RJ45 Ethernet port, FT1A project files can be remotely uploaded or downloaded over an Ethernet connection. Critical logging data can also be retrieved quickly.

Modbus TCP or RTU

The built-in Ethernet ports allow the FT1A Touch to be configured as a Client (Master) or Server (Slave) on the Modbus network. Modbus RTU (Master) is also supported. With these capabilities, FT1A Touch can communicate with other PLCs or devices using Modbus protocol.

Ladder Program and I/O status

Ladder programs can easily be monitored and controlled on the 3.8" (3.7" monochrome) display. It is a unique tool to debug the system without using WindLDR software and a PC. I/O status and any control parameter such as data register, timer, and internal relay can also be monitored and controlled.



Fast Start-up

Once power is applied to the FT1A Touch, it takes only 3 seconds for it to be fully functional. The fast start-up allows for fast, easy debugging and stress-free operation.



The Value of Our Controllers is in the Details

FT1A Controllers

FT1A controllers are designed for a range of applications that demand powerful and abundant features. Available with 12, 24, 40 and 48 I/O with and without embedded LCD/keypad, these controllers enable engineers to design cost-effective solutions.

Smart LCD Screen

The display (24 digits x 4 lines) can provide visual feedback of system status, I/O status, user configurable messages with dynamic data, bar graph, and ladder program monitor and controls.

Non-LCD Model

FT1A controllers are also available without embedded LCD/keypad. It's a cost-effective, tamper-proof solution.

USB mini-B

With the USB mini-B port, communication with FT1A controllers is extremely convenient as standard USB Type A to mini-B cables can be used.

Note: Features available on specific models.
See page 14 for selection guide.

Universal Voltages

24V DC or 100-240V AC



Actual Size

Memory Cartridge

The optional memory cartridge can be used to easily transfer programs from the internal ROM memory of FT1A controllers to a memory cartridge or vice versa. It's a convenient method to update the PLC program in the field.

Digital, Analog and High-speed Inputs

Inputs on the 24V DC power models can be configured as digital, 0-10V DC analog or high-speed counters. Up to 8 analog inputs with 10-bit resolution and up to 6 HSC 100kHz can be configured.



RJ45 Ethernet Port

The embedded Ethernet port on the FT1A controllers provides users with easy access for remote maintenance and communication. It also supports industry standard Modbus TCP protocol. With Ethernet Remote I/O capability, the FT1A controller's I/O can be easily expanded.

Real-Time Clock

Every FT1A controller is equipped with an embedded real-time clock for time-controlled applications. With the built-in, real-time clock, log data can also be tracked and, with just a click, daylight savings time can easily be setup.

RS232C and RS485 Ports

Up to two RS232C and/or RS485 communication cartridges can be plugged into the FT1A controllers to allow the PLC to communicate with other serial devices. It also supports industry standard Modbus RTU protocol.

Large Programming Memory

With up to 47.4KB (11,850 steps) of programming memory, FT1A controllers have enough memory for even complex PLC programming.

SD Memory Card

With the embedded SD memory slot, critical data can be easily logged and retrieved over Ethernet connections or simply remove the SD card and plug it into your PC.

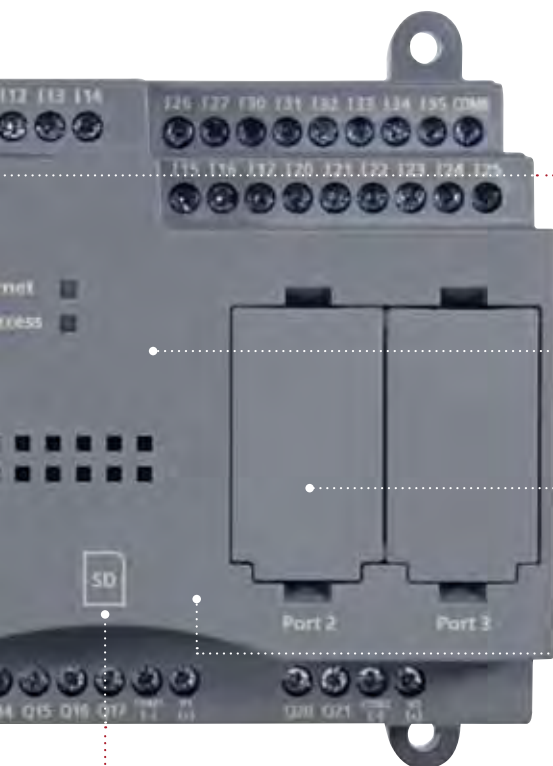

10A Relay and High-speed Outputs

The FT1A controller with relay outputs is equipped with four 10A relay contacts. The transistor outputs model is also equipped with two 100kHz high-speed outputs for simple positioning controls. With remote I/O capability, additional outputs can easily be added.



A Closer Look at Our Feature-rich Controllers

From Connecting to Remote Access

From connectivity to remote access to visual display, FT1A leads the way with versatile, full-featured controllers. No other controllers offer such a broad range of capabilities at such a competitive price.

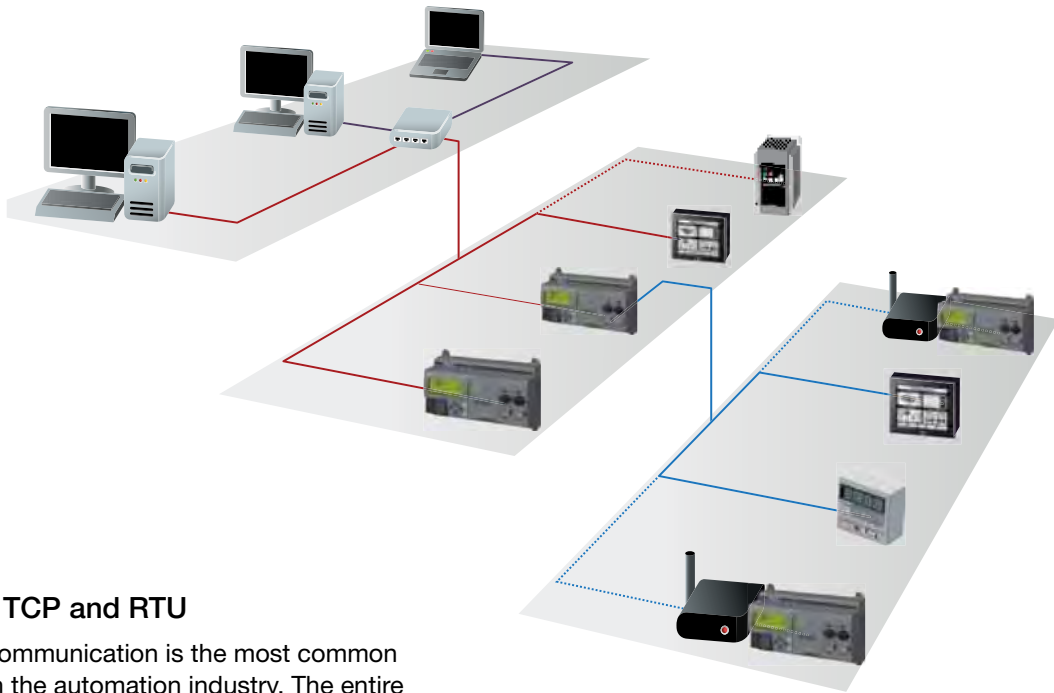

Modbus TCP and RTU

Modbus communication is the most common protocol in the automation industry. The entire FT1A family (except the 12 I/O CPU) supports Modbus TCP and Modbus RTU, making communication with other devices a breeze.

Ethernet Connectivity

Thanks to the embedded RJ45 Ethernet port (on all models except 12 I/O), FT1A controllers can be easily accessed from remote locations. Using WindLDR software, PLC programs can be updated remotely and critical parameters monitored and controlled. Remote connectivity is a critical part of today's control environment, and FT1A controllers meet every challenge with fast, easy, and reliable Ethernet connectivity.

SD Memory Card

FT1A 40 and 48 I/O controllers are equipped with an SD memory slot for data logging. Memory cards up to 32GB are supported. Log data is time/date stamped and stored in .CSV format, making it simple to review and analyze critical system data.

Smart LCD Display

With the embedded LCD screen, I/O status, system menus, customized dynamic messages, and bar-graph readouts can all be configured and displayed. Ladder programs can be displayed and controlled as well. You can configure up to 50 customized messages, all with dynamic values (24 digits by 4 lines max.). The backlight can be turned on or off. Scrolling and flashing are also supported.

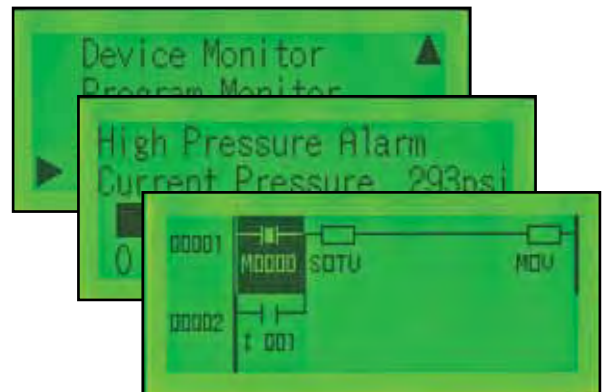

Remote I/O

The FT1A remote I/O, available in all Ethernet-capable modules, enables you to expand the number of inputs and outputs by simply connecting separate FT1A modules via Ethernet as remote I/O slaves. The FT1A remote I/O can monitor and control a total of 192 points of I/O.

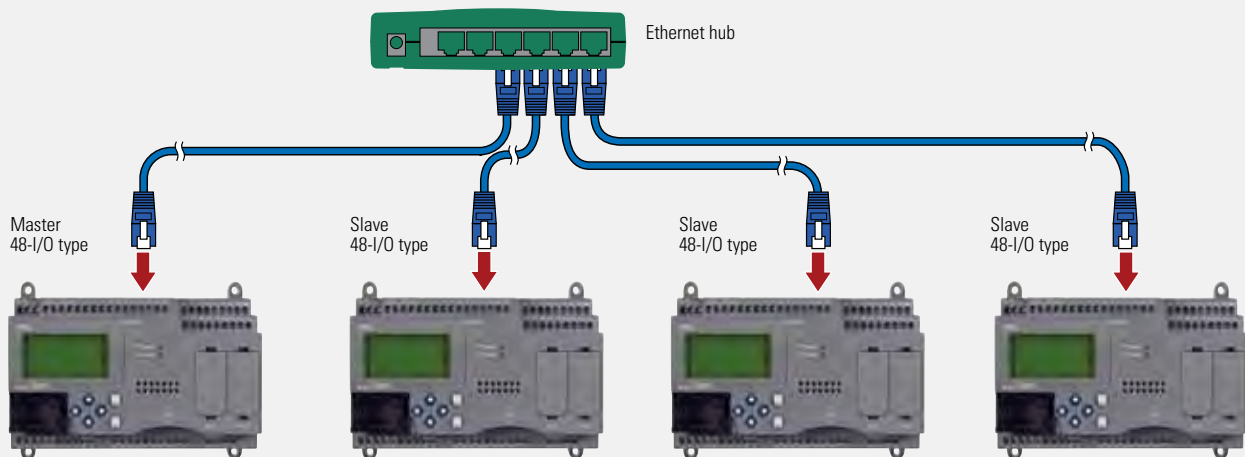

48-I/O type (master) + 48-I/O type (slave) + 48-I/O type (slave) + 48-I/O type (slave) = 192 I/O
 (30 inputs, 18 outputs) + (30 inputs, 18 outputs) + (30 inputs, 18 outputs) + (30 inputs, 18 outputs) = 120 inputs, 72 outputs

Built-in Analog Inputs

The FT1A controllers support up to 8 built-in, 0-10V DC analog inputs with 10-bit resolution, depending on the model. Having the option to configure the analog inputs on the CPU saves you time, space and money.

100kHz, High-Speed Counters and Outputs

Models with transistor outputs feature two 100kHz high-speed outputs for positioning control and all FT1A controllers are equipped with up to six 100kHz high-speed counters.

10 Amp Relay Contacts

FT1A controllers with relay outputs offer 10 Amp rated contacts. Traditional PLC relays are only rated for 2 Amps. Therefore, FT1A controllers reduce the need for, and spare you the cost of, using interposing relays.

Built-in Real Time Clock

Equipped with a real-time clock for use with any time-controlled applications, FT1A controllers have built-in support for US, Canadian, European, and Australian daylight savings time. The option for the user to configure their own custom daylight savings schedule is also available, providing the utmost in flexibility.

USB Maintenance Port

A convenient USB mini-B maintenance port is standard on all FT1A controllers, which means any standard Type A to mini-B USB cable can be used. No special cable is necessary.

Our Automation Organizer Software is Simple and Intuitive

A Complete Automation Suite: All-in-one Configuration Software

Automation Organizer (AO) is a powerful software suite containing WindLDR PLC programming software, WindO/I-NV2 HMI configuration software, WindO/I-NV3 FT1A Touch configuration software, and WindCFG system configuration software. AO is an all-in-one automation software package for IEC PLCs and IEC HMIs. The news gets even better, because AO software upgrades are always FREE.

WindO/I-NV3

WindO/I-NV3 is our exclusive configuration software for the FT1A Touch. Using the same platform as WindO/I-NV2 HG HMI programming software, WindO/I-NV3 provides users with the same intuitive experience. Users can easily display alarm screens, trend and bar graphs, scrolling texts and meters. With thousands of industry-standard bitmap libraries, creating a professional interface is just a click away.

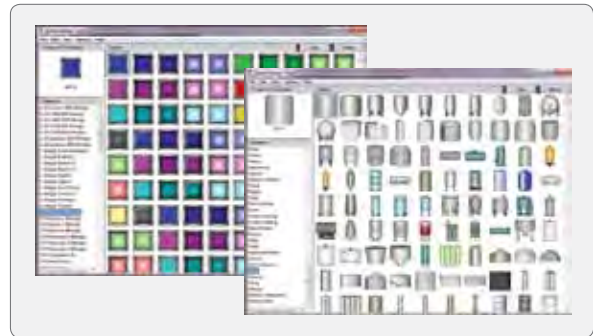

WindLDR

All IEC PLCs—including the FT1A family—are programmed with WindLDR software. This icon-driven programming tool combines logic and intuition with an incredibly easy-to-use interface. Offline simulation, I/O Force and program bookmarks are just some of the standard features you'll find in WindLDR. Newly added for FT1A are Function Block Diagram (FBD) and Script programming. Over the years, WindLDR has proven to be the most user-friendly, intuitive software available for beginners and advanced programmers alike.

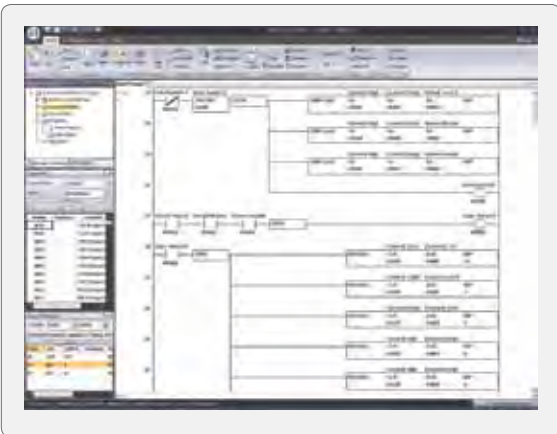

Simulation Mode

WindLDR allows you to simulate ladder and Function Block Diagram (FBD) programs in FT1A. You can easily test and verify functionality of your ladder and FBD programs without having to connect any hardware.

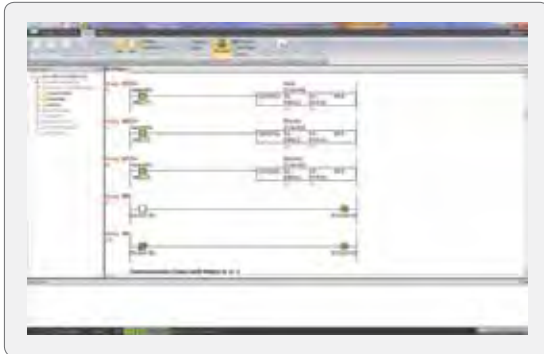

Comment Download Settings

The comment download settings allow you to choose whether to download Tag names, rung comments, custom monitor dialog boxes or file names. The biggest advantage of utilizing these settings is that once a program is retrieved from the PLC, all these important parameters will be available.

Function Block and Scripting

In addition to ladder logic, WindLDR now supports Function Block Diagram (FBD) and Script programming. With the FT1A controllers, you now have the flexibility and convenience of programming using any or all of these methods.

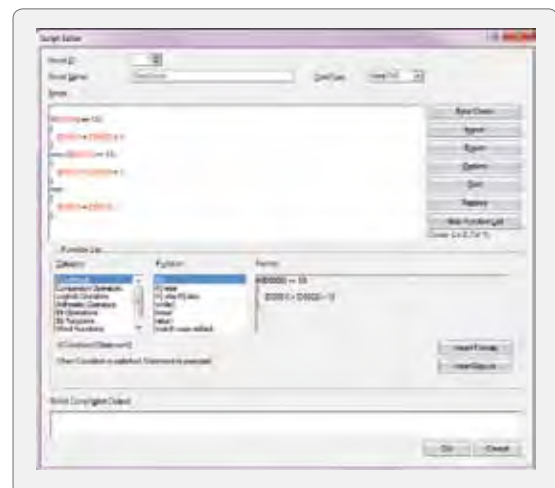





Free 30-Day Demo

Curious to see how an IDEC FT1A SmartAXIS controller might complement your design? Find out for yourself!

Just go to www.IDEC.com/download and download your free 30-day demo.

Selection Guide and Part Number Listing

Touch Part Numbers

Touch	Part Number	Screen Type	Total I/O	Input Type	Embedded Analog Inputs	Output Type	Analog Expansion Cartridges	Power Voltage	Remote I/O Master	
	FT1A-M14KA-W	3.7" STN Monochrome (8 shades)	14 points (8/6)	Source	2pt (0-10VDC, 4-20mA, 10-bit Resolution)	Transistor Sink	Yes, up to 2 cartridges	24V DC	Yes	
	FT1A-M14KA-B									
	FT1A-M14KA-S									
	FT1A-M14SA-W			Sink		Transistor Source				
	FT1A-M14SA-B									
	FT1A-M14SA-S									
	FT1A-C14KA-W	3.8" TFT 65,536 colors	14 points (8/6)	Source	2pt (0-10VDC, 4-20mA, 10-bit Resolution)	Transistor Sink	Yes, up to 2 cartridges	24V DC	Yes	
	FT1A-C14KA-B									
	FT1A-C14KA-S									
	FT1A-C14SA-W			Sink		Transistor Source				
	FT1A-C14SA-B									
	FT1A-C14SA-S									
	FT1A-M12RA-W	3.7" STN Monochrome (8 shades)	12 I/O (8 in, 4 out)	Sink	2pt (0-10VDC, 10-bit Resolution)	Relay	-	-	Yes	
	FT1A-M12RA-B									
	FT1A-M12RA-S									
		FT1A-C12RA-W								3.8" TFT 65,536 colors
		FT1A-C12RA-B								
		FT1A-C12RA-S								

Touch Accessories

Part Number	Description
FC6A-PJ2A	2-pt 0-10V, 4-20mA Analog input cartridge
FC6A-PK2AV	2-pt 0-10V Analog output cartridge
FC6A-PJ2AW	2-pt 4-20mA Analog output cartridge
FC6A-PJ2CP	2-pt RTD, Thermocouple cartridge
FT9Z-1D3PN05	FT1A Touch screen protective sheet (5 per pack)
FT9Z-1E3PN05	FT1A Touch protective cover (5 per pack)
FT9Z-1A01	FT1A Touch rear mount adapter
FT9Z-1T09	FT1A Touch extra communication terminal block
FT9Z-1X03	FT1A Touch extra power supply terminal block
HG9Z-4K2PN04	FT1A Touch extra mounting brackets (4 per pack)
HG9Z-XU1PN05	USB cable lock-in (5 per pack)
SW1A-W1C	Automation Organizer Software Suite

Controller Accessories

Part Number	Description
FT1A-PC1	RS232C communication adapter, mini-DIN type
FT1A-PC2	RS485 communication adapter, mini-DIN type
FT1A-PC3	RS485 communication adapter, screw terminal type
FT1A-PM1	Optional memory cartridge
FT9Z-PSP1PN05	Extra direct mounting hook (5 per pack)
SW1A-W1C	Automation Organizer Software Suite

Controller Part Numbers

12 I/O CPU	Part Number	Power Voltage	Total I/O	Input Type	Output Type	Ethernet Port	Screen Type	Embedded Analog Inputs	High-Speed Counter	SD Memory Slot	RS232C, RS485 Port
	FT1A-H12RC	100-240V AC	12 I/O (8 in, 4 out)	Contact	Relay	—	2.1" Monochrome	—	—	—	—
	FT1A-H12RA	24V DC		Sink				2pt, 0-10VDC, 10-bit	4 x 100kHz		
	FT1A-B12RC	100-240V AC		Contact				—	—		
	FT1A-B12RA	24V DC		Sink				2pt, 0-10VDC, 10-bit	4 x 100kHz		
24 I/O CPU											
	FT1A-H24RC	100-240V AC	24 I/O (16 in, 8 out)	Sink/Source	Relay	Yes	2.1" Monochrome	—	—	—	Optional Adapter
	FT1A-H24RA	24V DC		Sink				4pt, 0-10VDC, 10-bit	6 x 100kHz		
	FT1A-B24RC	100-240V AC		Sink/Source				—	—		
	FT1A-B24RA	24V DC		Sink				4pt, 0-10VDC, 10-bit	6 x 100kHz		
40 I/O CPU											
	FT1A-H40RC	100-240V AC	40 I/O (24 in, 16 out)	Sink/Source	Relay	Yes	2.1" Monochrome	—	—	Yes	Optional Adapters (x2)
	FT1A-H40RKA	24V DC		Source	Relay/Trans. Sink			6pt, 0-10VDC, 10-bit	6 x 100kHz		
	FT1A-H40RSA			Sink	Relay/Trans. Source						
	FT1A-B40RC	100-240V AC		Sink/Source	Relay			—	—		
	FT1A-B40RKA	24V DC		Source	Relay/Trans. Sink			6pt, 0-10VDC, 10-bit	6 x 100kHz		
	FT1A-B40RSA			Sink	Relay/Trans. Source						
48 I/O CPU											
	FT1A-H48SC	100-240V AC	48 I/O (30 in, 18 out)	Sink/Source	Transistor Source	Yes	2.1" Monochrome	—	—	Yes	Optional Adapters (x2)
	FT1A-H48SA	24V DC		Sink	Transistor Source			8pt, 0-10VDC, 10-bit	6 x 100kHz		
	FT1A-H48KC	100-240V AC		Sink/Source	Transistor Sink			—	—		
	FT1A-H48KA	24V DC		Source				8pt, 0-10VDC, 10-bit	6 x 100kHz		
	FT1A-B48SC	100-240V AC		Sink/Source	Transistor Source			—	—		
	FT1A-B48SA	24V DC		Sink	Transistor Source			8pt, 0-10VDC, 10-bit	6 x 100kHz		
	FT1A-B48KC	100-240V AC		Sink/Source	Transistor Sink			—	—		
	FT1A-B48KA	24V DC		Source				8pt, 0-10VDC, 10-bit	6 x 100kHz		

SmartAXIS Series FT1A Controller

Powerful controller with embedded I/O.

Touch, Pro, and Lite models for flexible use in almost all applications.

- Drag & drop action of function block diagram (FBD) makes programming easy (except PID control).
- Addition of scripts to WindLDR makes it easy to manage multiple processing (55 scripts total).
- Digital/analog-compatible input available for 24V DC. Convenient for systems requiring minimal analog inputs.
- 10A output relays connect directly to small motors and solenoid valves.
- Supports communication via RS232C, RS485, and Ethernet.
- USB programming port.
- User's program can be changed with the memory cartridge (Pro/Lite) or USB memory (Touch).
- Certified for marine use (except transistor output type).

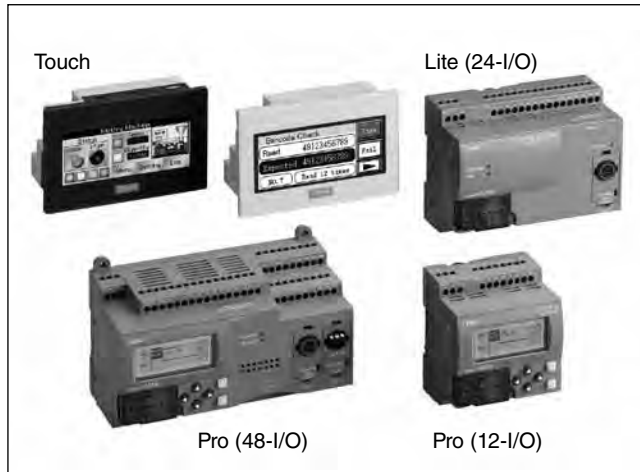

Touch (Display model)

- By integrating the control function (same functionality as Lite 12-I/O type) with a small display, a connected device is not needed. Wire and space-saving features offer the ideal solution for cost- and time-savings.
- Touch is an advanced small display with integrated control function.
- The transistor output models are suitable for applications where the durability of relay contacts is a concern.
- Connection to analog devices is possible with the transistor output model with two analog inputs (0-10V/4-20mA) and two analog outputs (0-10V/4-20mA), reducing installation space and costs.
- Installing analog cartridges on the transistor output model achieves a maximum of AI/AO: 2/6, 4/4, and 6/2 system configuration (when using two analog expansion cartridges). Adding the temperature input type cartridge enables simple PID control.
- PID control can be programmed easily and intuitively with the enhanced, proprietary dialog in WindLDR. PID monitor function greatly reduces the engineering time necessary for program debugging and system setup.
- Ethernet remote I/O master is available.
- 400cd/m² high-contrast and 65,536 color high-resolution TFT LCD provides unparalleled visibility.
- Adjustable LED brightness function.
- Monochrome STN models are equipped with a 740 cd/m² brightness LCD and backlit with a choice of 3 colors (pink, red, white), providing practically the same brightness as the color LCD models.
- Program both the Pro and Lite models using WindLDR and the Touch model using WindO/I-INV3. Our intuitive programming software that is easy even for the first-time users.

NEW



Touch (relay output)
(photo: FT1A-*12RA-B)



Touch (transistor output)
(photo: FT1A-*14SA-W with analog expansion cartridges)

Pro (LCD Model) / Lite (No LCD Model)

- Parameters such as counters and timers can be adjusted using the LCD and six operations buttons (also available on Touch).
- Monitor screens on LCD show system status and settings. "I/O status monitor" screen for monitoring I/O status "Device monitor" screen for monitoring SmartAXIS device values "Ladder Monitor" screen for monitoring the operating ladder program "Status monitor" screen: also useful for confirming protection status and scan time The states of four operation buttons can be used as digital inputs in the user programs.
- Supports positioning control with a single-phase (100 kHz)/4 point or a single-phase (100 kHz)/two-phase (50 kHz)/2 point high-speed counter input and 100 kHz/2 point pulse output. The new ARAMP instruction and enables you to program complex positioning systems easily.
- Integrated data logging function using an SD memory card. Logged data is useful for system maintenance management. (Touch: available using USB memory)
- Lite (No LCD) is available, offering more options for product selection.
- A maximum of 144 I/Os can be added using the remote I/O function with Ethernet. (Input: 90 I/O max., Output: 54 I/O max.)



Pro
(photo: FT1A-H48KC when using communication cartridge)



Lite
(photo: FT1A-B24RA when using communication cartridge)

FT1A

Touch (Display Models)

Package Quantity: 1

Type	Power	I/O	Input		Output	Program Size (ladder/FBD)	Interfaces	LCD	Bezel Color	Part No.	
			Digital I/O	Analog I/O (Note 1)							
Relay Output	24V DC	12 points (8/4)	6 (sink) (24V DC)	2	4 points 10A relay output	Program size: 47.4/38kB Configuration memory size: 5 MB	USB-A USB-mini B RS232C RS422/485 Ethernet	STN monochrome	Light gray	FT1A-M12RA-W	
									Dark gray	FT1A-M12RA-B	
									Silver	FT1A-M12RA-S	
		TFT color	Light gray	FT1A-C12RA-W							
			Dark gray	FT1A-C12RA-B							
			Silver	FT1A-C12RA-S							
Transistor Output	24V DC	14 points (8/6)	6 (source) (24V DC)	2	4 points Tr. sink output 2 points analog output	Program size: 47.4/38kB Configuration memory size: 5 MB	USB-A USB-mini B RS232C RS422/485 Ethernet	STN monochrome	Light gray	FT1A-M14KA-W	
			6 (sink) (24V DC)	2	4 points Tr. source output 2 points analog output				Dark gray	FT1A-M14KA-B	
			6 (source) (24V DC)	2	4 points Tr. sink output 2 points analog output				Silver	FT1A-M14KA-S	
			TFT color	Light gray	FT1A-M14SA-W						
				Dark gray	FT1A-M14SA-B						
				Silver	FT1A-M14SA-S						
		14 points (8/6)	24V DC	6 (source) (24V DC)	2	4 points Tr. sink output 2 points analog output	Program size: 47.4/38kB Configuration memory size: 5 MB	USB-A USB-mini B RS232C RS422/485 Ethernet	TFT color	Light gray	FT1A-C14KA-W
										Dark gray	FT1A-C14KA-B
										Silver	FT1A-C14KA-S
				TFT color	Light gray	FT1A-C14SA-W					
					Dark gray	FT1A-C14SA-B					
					Silver	FT1A-C14SA-S					

Pro (LCD Models)

Package Quantity: 1

Power	I/O	Input		Output	High-Speed Tr. Output	Program Size (ladder/FBD)	Interfaces					Part No.		
		Digital I/O	Analog I/O (Note 1)				USB mini-B Port	Ethernet Port	Expansion communication port (Note 2)		Memory Cartridge		SD Memory Card	
24V DC	12 points (8/4)	24V DC Input	6	2	4 points 10A relay output	12/10 kB	×	×	×	×	×	×	FT1A-H12RA	
	24 points (16/8)		12	4	4 points 10A relay output 4 points 2A relay output								FT1A-H24RA	
	40 points (24/16)		18	6	4 points 10A relay output 8 points 2A relay output								4 points Tr. sink output 4 points Tr. source output	FT1A-H40RKA
	48 points (30/18)		22	8	18 points Tr. sink output 18 points Tr. source output								FT1A-H40RSA	
													FT1A-H48KA	
FT1A-H48SA														
100 to 240V AC	12 points (8/4)	24V DC Input	8	—	4 points 10A relay output	12/10 kB	×	×	×	×	×	×	FT1A-H12RC	
	24 points (16/8)		16		4 points 10A relay output 4 points 2A relay output								FT1A-H24RC	
	40 points (24/16)		24		4 points 10A relay output 12 points 2A relay output								FT1A-H40RC	
	48 points (30/18)		30		18 points Tr. sink output 18 points Tr. source output								FT1A-H48KC	
													FT1A-H48SC	

Lite (No LCD Models)

Package Quantity: 1

Power	I/O	Input		Output	High-Speed Tr. Output	Program Size (ladder/FBD)	Interfaces					Part No.		
		Digital I/O	Analog I/O (Note 1)				USB mini-B Port	Ethernet Port	Expansion communication port (Note 2)		Memory Cartridge		SD Memory Card	
24V DC	12 points (8/4)	24V DC Input	6	2	4 points 10A relay output	12/10 kB	×	×	×	×	×	×	FT1A-B12RA	
	24 points (16/8)		12	4	4 points 10A relay output 4 points 2A relay output								FT1A-B24RA	
	40 points (24/16)		18	6	4 points 10A relay output 8 points 2A relay output								4 points Tr. sink output 4 points Tr. source output	FT1A-B40RKA
	48 points (30/18)		22	8	18 points Tr. sink output 18 points Tr. source output								FT1A-B40RSA	
													FT1A-B48KA	
FT1A-B48SA														
100 to 240V AC	12 points (8/4)	24V DC Input	8	—	4 points 10A relay output	12/10 kB	×	×	×	×	×	×	FT1A-B12RC	
	24 points (16/8)		16		4 points 10A relay output 4 points 2A relay output								FT1A-B24RC	
	40 points (24/16)		24		4 points 10A relay output 12 points 2A relay output								FT1A-B40RC	
	48 points (30/18)		30		18 points Tr. sink output 18 points Tr. source output								FT1A-B48KC	
													FT1A-B48SC	



Note 1: Digital/analog-compatible input

Note 2: The following communication cartridges can be connected.

FT1A-PC1: RS232C, mini-DIN type, FT1A-PC2: RS485, mini-DIN type, FT1A-PC3: RS485, terminal block type

Options / Maintenance Parts

Options

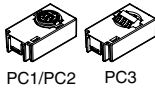
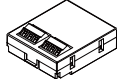
Name/Appearance	Applicable Model			Part No. (Ordering No.)	Package Quantity	Specifications	
	Touch	Pro	Lite				
Application software	×	×	×	SW1A-W1C	1	Automation Organizer Ver. 2.0 or higher (Note 1)	
USB maintenance cable 	×	×	×	HG9Z-XCM42	1	USB cable (length 2 m), USB-miniB	
Panel mount extension cable	×	—	—	HG9Z-XCE11	1	USB-A port extension cable (length 1 m)	
	×	×	×	HG9Z-XCE21	1	USB-mini B port extension cable (length 1 m)	
Screen protection sheet (Note 2)	×	—	—	FT9Z-1D3PN05	5		
Protective cover	×	—	—	FT9Z-1E3PN05	5		
Memory card 	— (Note 3)	×	×	HG9Z-XMS2	1	SD memory card (2 GB)	
Memory cartridge 	—	×	×	FT1A-PM1	1	Dedicated user program save memory (1 MB)	
Communication cartridge 	—	×	×	FT1A-PC1	1	RS232C, mini-DIN type	
	—	×	×	FT1A-PC2	1	RS485, mini-DIN type	
	—	×	×	FT1A-PC3	1	RS485, terminal block type	
Analog cartridge 	×	—	—	FC6A-PJ2A	1	Voltage/current input (2 points)	
	×	—	—	FC6A-PK2AV	1	Voltage output (2 points)	
	×	—	—	FC6A-PJ2AW	1	Current output (2 points)	
	×	—	—	FC6A-PJ2CP	1	Temperature input (2 points)	
Rear mount adapter	×	—	—	FT9Z-1A01	1	Rear mount bracket	
35-mm-wide DIN Rail	—	×	×	BAA1000PN10	10	Aluminum, 1,000mm long, 200g (approx.)	
	—	×	×	BAP1000PN10	10	Steel, 1,000mm long, 200g (approx.)	
DIN rail mounting bracket	—	×	×	BNL6PN10	10	DIN rail bracket	
Touch User's Manual	Japanese	×	—	—	FT9Y-B1389	1	
	English	×	—	—	FT9Y-B1390	1	
Pro/Lite User's Manual	Japanese	—	×	×	FT9Y-B1377	1	
	English	—	×	×	FT9Y-B1378	1	
SmartAXIS Ladder Programming Manual	Japanese	×	×	×	FT9Y-B1381	1	
	English	×	×	×	FT9Y-B1382	1	
FBD Programming Manual	Japanese	×	×	×	FT9Y-B1385	1	
	English	×	×	×	FT9Y-B1386	1	

Note 1: Upgrade from earlier version is possible on IDEC website.

The following manuals in PDF can be downloaded from <http://www.idec.com/language>.

FT1A SmartAXIS Touch User's Manual (English, Japanese, Simplified Chinese)

FT1A SmartAXIS Pro/Lite User's Manual (English, German, Japanese, Simplified Chinese)

FT1A SmartAXIS Ladder Programming Manual (English, German, Japanese, Simplified Chinese)

FT1A SmartAXIS FBD Programming Manual (English, German, Japanese, Simplified Chinese)

Note 2: UV resistance material is used. However, resistance against direct sunlight in outdoor usage is not guaranteed.





Note 3: Use commercially-available USB memory to store project data, log data, and recipe file of Touch models.

Note 4: Can be used for 40-I/O and 48-I/O types. Note that user programs cannot be stored or read using an SD memory card. If necessary, use a memory cartridge.

Note 5: Cannot be used for expansion with 12-I/O type. Not isolated from internal circuits.

Note 6: Cannot be used for expansion with relay output type.

Maintenance Parts

Name	Applicable Model			Part No. (Ordering No.)	Package Quantity	Specification
	Touch	Pro	Lite			
Communication Interface plug 	×	—	—	FT9Z-1T09	1	For communication ports (black) One supplied with Touch
Power supply plug 	×	—	—	FT9Z-1X03	1	For power supply terminals (black) One supplied with Touch
Mounting bracket 	×	—	—	HG9Z-4K2PN04	4	Two sets Two supplied with Touch
USB cable lock pin 	×	—	—	HG9Z-XU1PN05	5	Used when using the USB cable on a regular basis Two supplied with Touch
Direct mounting hook 	—	×	×	FT9Z-PSP1PN05	5	Direct mounting hook for Pro/Lite One set supplied with Pro/Lite

General Specifications

Touch (Display Model)

Part No.	FT1A-*12RA-*	FT1A-*14KA-* / FT1A-*14SA-*
Output	Relay output	Transistor output
Rated Power Voltage/ Power Supply Isolation	24V DC/Not isolated	
Allowable Voltage Range	20.4 to 28.8V DC (including ripple)	
Power Consumption	9.2W maximum	11W maximum
Allowable Momentary Power Interruption	10 ms maximum	
Dielectric Strength	1. Between power terminal and FE terminal: 500V AC, 5 mA, 1 minute 2. Between power terminal and output terminal: 2,300V AC, 5 mA, 1 minute	1. Between power terminal and FE terminal: 500V AC, 5 mA, 1 minute 2. Between power terminal and output terminal: 500V AC, 5 mA, 1 minute
EMC Immunity	IEC/EN 61131-2:2007 compliant	
Inrush Current	50A maximum (5ms maximum)	
Operating Temperature	Color display: -20 to +55°C, Monochrome display: 0 to +55°C (Note 1) (Note 2)	
Storage Temperature	-20 to +60°C (no freezing)	
Relative Humidity	10 to 95% RH (no condensation)	
Pollution Degree	2 (IEC 60664-1)	
Corrosion Immunity	Atmosphere free from corrosive gases	
Degree of Protection	IP66F TYPE 4X TYPE 13 (Panel front) (Note 3), IP20 (Rear)	
Ground	Functional grounding	
Protective grounding conductor	UL1007 AWG16	
Vibration Resistance	5 to 8.4 Hz half amplitude 3.5 mm, 8.4 to 150 Hz, acceleration 9.8 m/s ² (1G), 2 hours per axis on each of three mutually perpendicular axis (IEC 61131-2)	
Shock Resistance	147 m/s ² , 11 ms, X, Y, Z directions 3 times (IEC 61131-2)	
Mounting Structure	Panel mount	
Weight (approx.)	300g	250g

Note 1: FT1A-*12RA-* hardware version V130 (indicated on hardware) and earlier is UL, c-UL listed at 50°C (maximum operating temperature).

Note 2: See SmartAXIS Touch User's Manual FT9Y-B1390(2) for I/O derating.

Note 3: Operation not guaranteed when used with certain types of oils.

Pro/Lite (LCD Model/No LCD Model)

Part No.	Pro/Lite			
	12-I/O Type H12RA H12RC B12RA B12RC	24-I/O Type H24RA H24RC B24RA B24RC	40-I/O Type H40RKA H40RSA H40RC B40RKA B40RSA B40RC	48-I/O Type H48KA H48SA H48KC H48SC B48KA B48SA B48KC B48SC
Rated Power Voltage/ Power Supply Isolation	AC power: 100 to 240V AC/Isolation with transformer DC power: 24V DC/Not isolated			
Allowable Voltage Range	AC power: 85 to 264V AC DC power: 20.4 to 28.8V DC (including ripple)			
Rated Power Frequency	AC power: 50 to 60 Hz (47 to 63 Hz)			
Power Consumption	AC power	12-I/O: 18 VA maximum, 24-I/O: 41 VA maximum, 40-I/O: 48VA maximum, 48-I/O: 43 VA maximum		
	DC power	12-I/O: 4.3W maximum, 24-I/O: 4.8W maximum, 40-I/O: 7.9W maximum, 48-I/O: 6.0W maximum		
Allowable Momentary Power Interruption	AC power: 20 ms maximum, DC power: 10 ms maximum			
Dielectric Strength	AC power type: Between power/input and PE terminals: 1,500V AC, 5mA, 1 minute Between transistor output and PE terminals: 1,500V AC, 5mA, 1 minute Between relay output and PE terminals: 2,300V AC, 5mA, 1 minute Between power and input terminals: 1,500V AC, 5mA, 1 minute Between power/input and transistor output terminals: 1,500V AC, 5mA, 1 minute Between power/input and relay output terminals: 2,300V AC, 5mA, 1 minute DC power type: Between power/input and FE terminals: 500V AC, 5mA, 1 minute Between transistor output and FE terminals: 500V AC, 5mA, 1 minute Between relay output and FE terminals: 2,300V AC, 5mA, 1 minute Between power/input and transistor output terminals: 500V AC, 5mA, 1 minute Between power/input and relay output terminals: 2,300V AC, 5mA, 1 minute			
EMC Immunity	IEC/EN 61131-2:2007 compliant			
Inrush Current	AC power: 35A maximum (Cold start with Ta=-25°C, 200V AC) DC power: 30A maximum (5ms maximum)			
Operating Temperature	0 to +55°C (Note)			
Storage Temperature	-25 to +70°C (no freezing)			
Relative Humidity	10 to 95% RH (no condensation)			
Pollution Degree	2 (IEC 60664-1)			
Corrosion Immunity	Atmosphere free from corrosive gases			
Degree of Protection	IP20 (IEC 60529)			
Ground	D-type ground (Class 3 ground)			
Protective grounding conductor	UL1007 AWG16			
Vibration Resistance	5 to 8.4 Hz half amplitude 3.5 mm, 8.4 to 150 Hz, acceleration 9.8 m/s ² (1G), 2 hours per axis on each of three mutually perpendicular axis (IEC 61131-2)			
Shock Resistance	147 m/s ² , 11 ms, X, Y, Z directions 3 times (IEC 61131-2)			
Mounting Structure	DIN rail or direct mount			
Weight (approx.)	AC power	12-I/O: 230g, 24-I/O: 400g, 40-I/O: 580g, 48-I/O: 540g		
	DC power	12-I/O: 190g, 24-I/O: 310g, 40-I/O: 420g, 48-I/O: 380g		

Note: Hardware version V110 (indicated on hardware) is UL, c-UL Listed at 50°C (maximum operating temperature).

Function Specifications (Touch)

Part No.		Touch			
		FT1A-*12RA-*	FT1A-*14KA-*	FT1A-*14SA-*	
Control System		Stored program system			
Ladder Program	Instruction Words	Basic Instructions	42 types		
		Advanced Instructions	98 types	99 types	
	Program Capacity		Program size: 47.4 kB, Configuration memory capacity: 5 MB		
	Processing Time	Basic Instruction	1850μs/1,000 steps		
END Processing		5 msec minimum			
FBD	FB		37 types		
	Program Capacity		Program size: 38kB, Configuration memory capacity: 5MB		
	No. of FB	FB (Note 1)	1,000		
		Timer (T)	200		
		Counter (C)	200		
Processing Time	Basic Instruction	4ms/100			
	END Processing	5ms minimum			
User Program Storage		Flash ROM (100,000 times)			
I/O Points	Inputs	8 (V3.90 or above: 90 max. can be added with remote I/O master function)	8 (90 max. can be added with remote I/O master function)		
	Outputs	4 (V3.90 or above: 54 max. can be added with remote I/O master function)	4 (54 max. can be added with remote I/O master function)		
Analog Input		2 (V3.90 or above: 24 max. can be added with remote I/O master function)	2 (4 max. can be added with analog cartridge, and 24 max. can be added with remote master function)		
Analog Output		—	2 (4 max. can be added with analog cartridge)		
Internal Relays		1,024			
Shift Registers		128			
Data Registers		2000			
Special Data Registers		200			
Counters		200			
Timer (1ms, 10 ms, 100 ms, 1s)		200			
Clock		Precision: ±30 seconds/month (25°C, typical)			
RAM Backup	Backup Data		Internal relays, shift registers, counters, data registers, clock data		
	Backup Duration		Approximately 30 days (typical) at 25°C after backup battery is fully charged		
	Battery		Lithium secondary battery		
	Charging Time		Approximately 15 hours required to charge from 0 to 90%		
	Replaceability		Not possible		
Self-Diagnostic Functions		Keep data check, power failure check, watchdog timer check, timer/counter preset value change error check, user program syntax check, user program execution check			
Input Filter		No filter, 3 to 15 ms (selectable in increments of 1 ms)			
Catch Input/Interrupt Input		4/4			
High-speed Counter	Maximum Counting Frequency and Points	Single/two-phase selectable	1 (5 kHz, multiple 2/4, single-phase cannot be used)		
		Single-phase	4 (x 10 kHz)		
	Counting Range		0 to 4,294,967,295 (32 bits)		
	Operation Mode		Rotary encoder mode and adding counter mode		
Analog Voltage Inputs	Built-in Points		2		
	Input Range	0 to 10V DC	0 to 10V DC (voltage input) / 4 to 20 mA (current input)		
	Input Impedance	78 kΩ	78 kΩ (voltage input) / 250 Ω (current input)		
	Digital Resolution	0 to 1,000 (10 bits)			
Number of Relay Outputs		10A relay: 4			
Number of Transistor Outputs		—	4 (sink)	4 (source)	
Analog Output	Built-in Points		2		
	Output Range		0 to 10V DC (voltage output) / 4 to 20 mA (current output)		
	Digital Resolution		0 to 1,000 (10 bits)		
Pulse Outputs	100 kHz	No. of outputs	—		
		Function	—		
	5 kHz	No. of outputs	—		
		Function	—		
External Output Power Supply for Sensor	Output Voltage		—		
	Output Current		—		
	Overload Detection		—		
	Insulation		—		
USB-mini B (Note 2)		×			
USB-A (Note 2)		×			
RS232C (Note 2)		×			
RS485/422 (Note 2)		×			
Ethernet		×			
Expansion Communication Ports	Port 2		—		
	Port 3		—		
Memory Cartridge		—			
SD Memory Card		—			
Analog Cartridge Interface	Number of Ports		2		
	Connectable Cards		4 (FC6A-PJ2A, FC6A-PK2AV, FC6A-PK2AW, FC6A-PJ2CP)		

Note 1: Except for timer, counter, input FB, and output FB.

Note 2: Not isolated from internal circuits.

Function Specifications (Pro/Lite)

Part No.			Pro/Lite FT1A-							
			H12RA B12RA	H12RC B12RC	H24RA B24RA	H24RC B24RC	H40RKA H40RSA B40RKA B40RSA	H40RC B40RC	H48KA H48SA B48KA B48SA	H48KC H48SC B48KC B48SC
Control System			Stored program system							
Ladder Program	Instruction Words	Basic Instructions	42 types							
		Advanced Instructions	99 types	98 types	103 types	102 types	110 types	104 types	110 types	109 types
	Program Capacity		12 kB (3000 steps equivalent)		47.4 kB (11,850 steps equivalent)					
	Processing Time	Basic Instruction	950 μs/1,000 steps							
END Processing		2 ms (Pro) / 640 μs (Lite)								
FBD	FB		38 types	37 types	38 types	37 types	45 types	39 types	45 types	44 types
	Program Capacity		10kB		38kB					
	No. of FB	FB (Note 1)	200		1,000					
		Timer (T)	100		200					
		Counter (C)	100		200					
	Processing Time	Basic Instruction	1.3ms/100							
END Processing		2.5ms (Pro)/1ms (Lite)								
User Program Storage			Flash ROM (10,000 times)							
I/O Points	Inputs		8		16		24		30	
	Outputs		4		8		16		18	
Internal Relays			256		1,024					
Shift Registers			128		128					
Data Registers			400		2000					
Special Data Registers			200		200					
Adding/Reversible Counters			100		200					
Timer (1ms, 10 ms, 10 ms, 1s)			100		200					
Clock			Precision: ±30 seconds/month (25°C, typical)							
RAM Backup	Backup Data		Internal relays, shift registers, counters, data registers, clock data							
	Backup Duration		Approximately 30 days (typical) at 25°C after backup battery is fully charged							
	Battery		Lithium secondary battery							
	Charging Time		Approximately 15 hours required to charge from 0 to 90%							
	Replaceability		Not possible							
Self-Diagnostic Functions			Keep data check, power failure check, clock error check, watchdog timer check, timer/counter preset value change error check, user program syntax check, user program execution check, system error check, memory cartridge transfer error check							
Input Filter			No filter, 3 to 15 ms (selectable in increments of 1 ms)							
Catch Input/Interrupt Input			4/4		6/6					
High-speed Counter	Maximum Counting Frequency and Points	Single/two-phase selectable	2 (Note 2)	—	2 (Note 2)	—	2 (Note 2)	—	2 (Note 2)	—
		Single-phase	2 (x 100 kHz)	—	4 (x 100 kHz)	—	4 (x 100 kHz)	—	4 (x 100 kHz)	—
	Counting Range		0 to 4,294,967,295 (32 bits)							
Operation Mode			Rotary encoder mode and adding counter mode							
Analog Voltage Inputs	Points		2	None	4	None	6	None	8	None
	Input Range		0 to 10V DC							
	Input Impedance		78 kΩ							
	Digital Resolution		0 to 1,000 (10 bits)							
Pulse Outputs	100 kHz	No. of outputs	—	—	—	—	2	—	2	
		Function	—	—	—	—	PULS, PWM, RAMP, ARAMP, ZRN	—	PULS, PWM, RAMP, ARAMP, ZRN	
	5 kHz	No. of outputs	—	—	—	—	2	—	2	
		Function	—	—	—	—	PULS, PWM	—	PULS, PWM	
External Output Power Supply for Sensor	Output Voltage		—	—	—	24V DC (+10%, -15%)	—	24V DC (+10%, -15%)	—	24V DC (+10%, -15%)
	Output Current		—	—	—	250 mA	—	300 mA	—	300 mA
	Overload Detection		—	—	—	Impossible	—	Impossible	—	Impossible
	Insulation		—	—	—	Internal Circuit	—	Internal Circuit	—	Internal Circuit
USB-mini B (Note 3)			×		×		×		×	
USB-A (Note 3)			—		—		—		—	
RS232C (Note 3)			—		× (Note 4)		× (Note 4)		× (Note 4)	
RS485 (Note 3)			—		× (Note 4)		× (Note 4)		× (Note 4)	
Ethernet			—		×		×		×	
Expansion Communication Ports	Port 2		—		×		×		×	
	Port 3		—		—		×		×	
Memory Cartridge			×		×		×		×	
SD Memory Card			—		—		× (Note 5)		× (Note 5)	

Note 1: Except for timer, counter, input FB, and output FB. Note 2: 100 kHz when single-phase, 50 kHz when two-phase, multiple 2.4
 Note 3: Not isolated from internal circuits. Note 4: When communication cartridge is installed.
 Note 5: The maximum capacity is 32 GB. DLOG/FB and TRACE/FB instructions are used to write data. For details, see page 32.

Display Specifications

Touch/Pro (Display Model/Built-in LCD)

Part No.	Touch		Pro
Display Element	TFT color LCD	STN monochrome LCD	STN monochrome LCD
Colors/Shades	65,536 colors	Monochrome 8 shades	Monochrome
Effective Display Area	88.92 W x 37.05 H mm	87.59 W x 35.49 H mm	47.98 W x 18.22 H mm
Display Resolution	240 W x 100 H pixels		192 W x 64 H pixels
View Angle	Left/right 40°, top 20°, bottom 60°	Left/right/top/bottom: 45°	Left/right 30°, top 20°, bottom 40°
Contrast Adjustment	Not possible	32 levels	Not possible
Backlight	LED	LED (white, red, pink)	LED (green)
Backlight Life	50,000 hours (Note 1)		—
Brightness	400 cd/m ² (Note 2)	740 cd/m ² (Note 2)	45 cd/m ²
Brightness Adjustment	32 levels		Not possible
Backlight Control	Auto off function		On/off
Backlight Replacement	Not possible		
Display Character Size	1/4 Size	8 x 8 pixels [JIS 8-bit code, ISO 8859-1 (Western European languages), ANSI 1250 (central Europe)], ANSI 1257 (Baltic), ANSI 1251 (Cyrillic)	
	1/2 Size	8 x 16 pixels [JIS 8-bit code, ISO 8859-1 (Western European languages), ANSI 1250 (central Europe)], ANSI 1257 (Baltic), ANSI 1251 (Cyrillic)	
		16 x 32 pixels, 24 x 48 pixels, 32 x 64 pixels (Western European languages: ISO 8859-1)	
	Full Size	16 x 16 pixels (Japanese JIS first and second level characters, simplified Chinese, traditional Chinese, Korean)	
Double Size	32 x 32 pixels (Japanese JIS first level characters, Mincho font)		16 x 16 pixels (Japanese JIS first level characters, Chinese)
No. of Characters	1/4 Size	30 characters x 12 lines/screen	
	1/2 Size	30 characters x 6 lines/screen	
	Full Size	15 characters x 6 lines/screen	
	Double Size	7 characters x 3 lines/screen	
Character Magnification	0.5x, 1x, 2x, 3x, 4x, 5x, 6x, 7x, 8x vertically and horizontally		—
Character Attributes	Blink, reverse, bold, shadowed (blink is 1 sec or 0.5 sec)		Blink, reverse
Graphics	Line, polyline, polygon, rectangle, circle, ellipse, arc, pie, equilateral polygons (3, 4, 5, 6, 8), fill, picture		—
Window Display	3 popup screens + 1 system screen		—

Note 1: The backlight life refers to the time until the brightness reduces by half after use at 25°C.

Note 2: Brightness of LCD only (monochrome LCD: when lit white).

Operation Specifications

Touch/Pro (Display/LCD Models)

Part No.	Touch	Pro
Switching Element	Analog resistive membrane (touch panel)	Rubber switches
Operating Force	0.2 to 2.5N	2.0 N minimum
Mechanical Life	1 million operations	10,000 operations
Acknowledgment Sound	Electric Buzzer	Not provided
Multiple Press	Not possible	Possible

HMI Function Specifications (Touch)

Functions	Drawings, bit button, word button, goto screen button, key button, multi-button, keypad, selector switch, potentiometer, numerical input, character input, pilot lamp, picture display, message display, message switching display, alarm list display, alarm log display, numerical display, bar chart, line chart, pie chart, meter, calendar, bit write command, word write command, goto screen command, timer, script command, multi-command, system area, start time, Auto Backlight OFF, O/I Link, user communication, maintenance communication, DM Link Communication, PLC Link Communication (Note 1), alarm log, data log, operation log, data storage area, preventive maintenance, recipe, text group, global script, user account, project data transfer using external memory, downloading logged data in external memory, USB auto-run function
-----------	---

Note 1: The up-to-date information on the connectable PLC can be obtained from <http://www.idec.com/language>.

Input Specifications (Touch/Pro/Lite)

Part No.		Touch			Pro/Lite FT1A-										
		12RA	*14KA*	*14SA*	H12RA B12RA	H12RC B12RA	H24RA B24RA	H24RC B24RC	H40RKA B40RKA	H40RSA B40RSA	H40RC B40RC	H48KA B48KA	H48SA B48SA	H48KC B48KC	H48SC B48SC
Digital Input	Input Points	6			6	8	12	16	18		24	22		30	
	Input Type	Sink	Source	Sink	Sink	No-voltage (with contact)	Sink	Sink/ Source	Source	Sink	Sink/ Source	Source	Sink	Sink/Source	
	Input Voltage Range	0 to 28.8V DC													
	Rated Input Current	4.4 mA	5.2 mA	4.4 mA	No-voltage type and sink/source type: 5.3 mA, sink type: 4.4 mA, source type: 5.2 mA										
	Input Impedance	5.5 kΩ	4.7 kΩ	5.5 kΩ	No-voltage type and sink/source type: 4.3 kΩ, sink type: 5.5 kΩ, source type: 4.7 kΩ										
	Input Delay Time	OFF → ON	2.5 μs + soft filter setting			40 μs + filter value (high-speed input section: 2.5 μs + soft filter value)									
		ON → OFF	5 μs + soft filter setting			150 μs + filter value (high-speed input section: 5 μs + soft filter value)									
	Isolation	Between input terminals	Not isolated			Not isolated									
		Internal circuit	Not isolated			No-voltage type and sink/source type: photocoupler isolated, sink type and source type: not isolated									
	Input Type	Type 1 (IEC 61131-2)													
	External Load for I/O Interconnection	Not needed													
	Operating Level	OFF voltage	Sink type: 5V DC max. Source type: 15V DC min.			No-voltage type: 18 kΩ min., sink/source type and sink type: 5 VDC max., source type: 15 VDC min.									
		ON voltage	Sink type: 15V DC min. Source type: 5V DC max.			No-voltage type: 2 kΩ max., sink/source type and sink type: 15 VDC min., source type: 5 VDC max.									
		OFF current	Sink type: 0.9 mA max. Source type: -1.0 mA min.			No-voltage type and sink/source type: 1.1 mA max., sink type: 0.9 mA max., source type: -1.0 mA min.									
		ON current	Sink type: 2.7 mA min. Source type: -3.0 mA max.			No-voltage type and sink/source type: 3.0 mA min., sink type: 2.7 mA min., source type: -3.0 mA max.									
Analog Input	Input Points	2			2	4	6	8							
	Input Type	Voltage input	Voltage/Current input		Voltage input	Voltage input	Voltage input		Voltage input		Voltage input				
	Input Range	0 to 10.0 VDC	0 to 10.0 VDC / 4 to 20 mA		0 to 10.0V DC	0 to 10.0V DC	0 to 10.0V DC		0 to 10.0V DC		0 to 10.0V DC				
	Sampling Duration Time	2 ms maximum			2 ms maximum	2 ms maximum	2 ms maximum		2 ms maximum		2 ms maximum				
	Total Input System Transfer Time	3 ms + sampling time + scan time	3 ms + sampling time + scan time (voltage input) 12 ms + sampling time + scan time (current input)		2 ms + filtering time + scan time	2 ms + filtering time + scan time	2 ms + filtering time + scan time		2 ms + filtering time + scan time		2 ms + filtering time + scan time				
	Digital Resolution	0 to 1,000 (10 bits)			0 to 1,000 (10 bits)	—	0 to 1,000 (10 bits)	—	0 to 1,000 (10 bits)	—	0 to 1,000 (10 bits)	—			
	Input Error	25°C	±3% of full scale			±1.5% of full scale	±1.5% of full scale	±1.5% of full scale		±1.5% of full scale		±1.5% of full scale			
		Total	±5% of full scale			±5% of full scale	±5% of full scale	±5% of full scale		±5% of full scale		±5% of full scale			
	Isolation	Between input terminals	Not isolated			Not isolated	Not isolated	Not isolated		Not isolated		Not isolated			
		Internal circuit	Not isolated			Not isolated	Not isolated	Not isolated		Not isolated		Not isolated			
When used as digital input	Digital I/O	Type 1 (not conforming to IEC 61131-2 digital I/O type)													
	Operation Level	OFF voltage: 5V maximum													
		ON voltage: 15V minimum													
		OFF current: 0.06 mA maximum													
ON current: 0.20 mA minimum															
External Power for Input	Input Voltage Range	—			—	—	20.4 to 26.4V DC	—	20.4 to 26.4V DC	—	—		20.4 to 26.4V DC		
	Output Current Capacity	—			—	—	250 mA	—	300 mA	—	—		300 mA		

Output Specifications (Touch)

Part No.			Touch FT1A-			
			12RA-	*14KA-*	*14SA-*	
Output Specification	Transistor Output	Output Points	Transistor Sink Output	4	—	
			Transistor Source Output	—	4	
		Rated Load Voltage		24V DC		
		Input Voltage Range		20.4 to 28.8V DC		
		Maximum Load Current	1 point	0.3A maximum		
			1 common	1A maximum		
		Voltage Drop (ON Voltage)		1V maximum (voltage between COM and output terminals when output is ON)		
		Inrush Current		1A		
		Leakage Current		0.1 mA maximum		
		Clamping Voltage		39V ± 1V		
		Maximum Lamp Load		8 W maximum		
		Inductive Load		L/R = 10 ms (28.8V DC, 1 Hz)		
		External Current Draw		100 mA maximum, 24V DC		
		Isolation	Between output terminal and internal circuit	Photocoupler isolated		
			Between output terminals	Not isolated		
Output Delay	OFF → ON	100µS max.				
	ON → OFF	200µS max.				
10A relay	Output Points	4	—	—		
	Output Type	1a contact	—	—		
	Rated Load Current	240V AC 10A, 30V DC 10A	—	—		
	Minimum Switching Load	10 mA/5V DC (reference value)	—	—		
	Initial Contact Resistance	100 mΩ maximum (1A, at 6V DC)	—	—		
2A relay	Output Points	—	—	—		
	Output Points per Common Line				COM4	
					COM5	
					COM6	
	Output Type				—	
	Maximum Load Current				1 point	
1 common						
Minimum Switching Load						
Initial Contact Resistance						
Relay Output Common	Electrical Life	100,000 operations minimum (resistive load 1,800 operations/h)	—	—		
	Mechanical Life	20 million operations minimum (no load 18,000 operations/h)	—	—		
	Dielectric Strength	Between output terminal and internal circuit	2,300V AC, 1 minute	—	—	
		Between output terminals (between COMs)	2,300V AC, 1 minute	—	—	
Analog Output	Output Points	—	—	2		
	Analogue Output Signal Type				Voltage/Current output (Selectable)	
	Analogue Output Range				0 to 10V DC / 4 to 20mA	
	Load Impedance				2kΩ min (voltage input) / 500 Ω max (current input)	
	Applicable Load Type				Resistive Load	
	Maximum Deviation at 25°C				±0.3% of full scale	
	Temperature Coefficient				±0.02%/°C of full scale	
	Repeatability After Stabilization Time				±0.4% of full scale	
	Non-linearity				±0.01% of full scale	
	Output Ripple				30mV max. (spike noise not included)	
	Overshoot				0% (Note 2)	
	Total Error				±1.0% of full scale including ripple	
	Effect of Improper Output Connection				No damage	
	Digital Resolution				0 to 1,000 (10 bits)	
	Output Value of LSB				10mV (0-10V) / 16µA (4-20mA)	
	Monotonicity				Yes	
Current loop open	Not detectable					

Note 1: High-speed output terminal (100 kHz pulse output terminal): 5 µs max. Normal output terminal (including 5kHz pulse output terminal): 100 µs max.
 Note 2: Overshoot may occur under light load conditions. Overshoot can be suppressed by inserting a damping resistor. Damping resistor value: approx. 150Ω including the input impedance.

Output Specifications (Pro/Lite)

Part No.			Pro/Lite FT1A-														
			H12RA B12RA	H12RC B12RC	H24RA B24RA	H24RC B24RC	H40RKA B40RKA	H40RSA B40RSA	H40RC B40RC	H48KC B48KC	H48SC B48SC	H48KA B48KA	H48SA B48SA				
Output Specification	Output Points	Transistor Sink Output							4	—		18	—	18	—		
		Transistor Source Output							—	4		—	18	—	18		
	Rated Load Voltage								24V DC		24V DC						
	Input Voltage Range								20.4 to 28.8V DC		20.4 to 28.8V DC						
	Maximum Load Current	1 point								0.3A maximum		0.3A maximum					
		1 common								1A maximum		1A maximum					
	Voltage Drop (ON Voltage)								1V maximum (voltage between COM and output terminals when output is ON)		1V maximum (voltage between COM and output terminals when output is ON)						
	Inrush Current								1A		1A						
	Leakage Current								0.1 mA maximum		0.1 mA maximum						
	Clamping Voltage								39V ± 1V		39V ± 1V						
	Maximum Lamp Load								8 W maximum		8 W maximum						
	Inductive Load								L/R = 10 ms (28.8V DC, 1 Hz)		L/R = 10 ms (28.8V DC, 1 Hz)						
	External Current Draw								100 mA maximum, 24V DC (V terminal supply power)		100 mA maximum, 24V DC (V terminal supply power)						
	Isolation	Between output terminal and internal circuit								Photocoupler isolated		Photocoupler isolated					
		Between output terminals								Same common line: Not isolated Separate common line: isolated		Same common line: Not isolated Separate common line: isolated					
	Output Delay	OFF → ON								(Note)		(Note)					
		ON → OFF								(Note)		(Note)					
	10A relay	Output Points		4													
		Output Type		1a contact													
		Rated Load Current		240V AC 10A, 30V DC 10A													
Minimum Switching Load		10 mA/5V DC (reference value)															
Initial Contact Resistance		100 mΩ maximum (1A, at 6V DC)															
2A relay	Output Points				4	4	8	8	12								
	Output Points per Common Line	COM4			4	4	4	4	4								
		COM5			—	—	4	4	4								
		COM6			—	—	—	—	4								
	Output Type		—		—		1a contact		1a contact								
	Maximum Load Current	1 point								240V AC 2A, 30V DC 2A		—		—		—	
		1 common								8A maximum							
Minimum Switching Load								1 mA/5 VDC (reference value)									
Initial Contact Resistance								30 mΩ maximum (1A, at 6V DC)									
Electrical Life								100,000 operations minimum (resistive load 1,800 operations/h)									
Mechanical Life								20 million operations minimum (no load 18,000 operations/h)									
Relay Output Common Dielectric Strength	Between output terminal and internal circuit								2,300V AC, 1 minute								
	Between output terminals (between COMs)								2,300V AC, 1 minute								

Note: High-speed output terminal (100 kHz pulse output terminal): 5 µs max. Normal output terminal (including 5kHz pulse output terminal): 100 µs max.

Analog Expansion Cartridge Specifications (FC6A-P)

Specifications

Part No.	FC6A-PJ2A	FC6A-PJ2CP	FC6A-PK2AV	FC6A-PK2AW
Type	Voltage/Current Input	Temperature Input	Voltage Output	Current Output
Number of Input/Output	2	2	2	2
Rated Voltage	5.0V, 3.3V (supplied from the Touch)			
Consumption Current	5.0V: – 3.3V: 30mA		5.0V: 70mA 3.3V: 30mA	5.0V: 185mA 3.3V: 30mA
Weight	15g			

Input Specifications

Part No.	FC6A-PJ2A		FC6A-PJ2CP		
Input Type	Voltage Input	Current Input	Resistance Thermometer	Thermocouple	
Input Range	0 to 10V DC	4 to 20mA DC 0 to 20mA DC	Pt100: –200 to +850°C Pt1000: –200 to +600°C Ni100: –60 to +180°C Ni1000: –60 to +180°C 3-wire RTD	K: –200 to 1300°C J: –200 to 1000°C R: 0 to 1760°C S: 0 to 1760°C B: 0 to 1820°C E: –200 to 800°C T: –200 to 400°C N: –200 to 1300°C C: 0 to 2315°C	
Input Impedance	1MΩ min.	250Ω max.	1MΩ min.		
Allowable Conductor Resistance	—		10Ω max.	—	
Input Detection Current	—		Typ: 0.2mA, 10mA max.	—	
AD Conversion	Sample Duration Time	10ms	250ms		
	Sample Interval	20ms	500ms		
	Total Input System Transfer Time	20ms + 1 scan		500ms + 1 scan	
	Type of Input	Single-ended input			
	Operating Mode	Self-scan			
Conversion Method	SAR				
Input Error	Maximum Error at 25°C	±0.1% of full scale	±0.1% of full scale	±0.1% of full scale Cold junction compensation accuracy ±4.0°C or less Exceptions R, S thermocouple error: ±6.0°C (0 to 200°C range only) B thermocouple error: Not guaranteed (0 to 300°C range only) K, J, E, T, N thermocouple error: ±0.4% of full scale (0°C or lower range only)	
	Temperature Coefficient	±0.02%/°C of full scale			
	Reproducibility After Stabilization Time	±0.5% of full scale			
	Non-linearity	±0.01% of full scale			
	Maximum Error	±1.0% of full scale			
	Digital Resolution	4096 (12 bits)		Pt100: 10,500 (14 bits) Pt1000: 8000 (13 bits) Ni100: 2400 (12 bits) Ni1000: 2400 (12 bits)	K: 15,000 (14 bits) J: 12,000 (14 bits) R: 17,600 (15 bits) S: 17,600 (15 bits) B: 18,200 (15 bits) E: 10,000 (14 bits) T: 6,000 (13 bits) N: 15,000 (14 bits) C: 23,150 (15 bits)
Data	LSB Input Value	2.44mV (0 to 10V DC) 4.88µA (DC0 to 20mA) 3.91µA (DC4 to 20mA)	0.1°C 0.18°F		
	Data Format in Application	Can be arbitrarily set for each channel in the range of –32,768 to 32,773			
	Monotonicity	Yes			
Noise Resistance	Maximum Temporary Deviation during Electrical Noise Tests	±4.0% of full scale			
	Recommended Cable	Shielded twisted pair	Twisted pair		
	Crosstalk	1LSB max.			
Isolation	None				
Effect When Input is Incorrectly Wired	No damage				
Maximum Allowable Constant Load (non-destructive)	13V DC	40mA	13V DC		
Input Type Modification	Software programming				
Calibration to Maintain Rated Accuracy	Impossible				

Output Specifications

Part No.	FC6A-PK2AV	FC6A-PK2AW
Type	Voltage Output	Current Output
Output Type	Voltage Output	Current Output
	0 to 10V DC	—
	—	4 to 20mA DC
Load	Impedance	2kΩ min.
	Load Type	500 kΩ max.
D/A Conversion	Cycle Time	20ms
	Settling Time	40ms max.
	Total Output System Transfer Time	40ms+1 scan
Output error	Maximum Error at 25°C	±0.3% of full scale
	Temperature Coefficient	±0.02%/°C of full scale
	Reproducibility after Stabilization Time	±0.4% of full scale
	Non-linearity	±0.01% of full scale
	Output Ripple	30mV max.
	Overshoot	0%
	Maximum Error	±1.0% of full scale
	Effect of Improper Output Terminal Connection	No damage
	Digital Resolution	4096 (12 bits)
	LSB Output Value	2.44mV (0 to 10V) 3.91µA (4 to 20mA)
Data	Data Format in Application	0 to 4095 (0 to 10V) 0 to 4095 (4 to 20mA)
	Monotonicity	Yes
	Open Current Loop	— Cannot be detected
Noise Resistance	Maximum Temporary Deviation during Electrical Noise Tests	±4.0 of full scale
	Recommended Cable	Shielded twisted pair
	Crosstalk	1 LSB max.
Isolation	None	
Calibration to Maintain Rated Accuracy	Impossible	
Selection of Output Signal Type	Voltage output only	Current output only

Applicable Wire

Cartridge Part No.	FC6A-PJ2A	FC6A-PJ2CP	FC6A-PK2AV	FC6A-PK2AW
Applicable Wire	0.3mm ² (AWG22) shielded twisted pair	0.3mm ² (AWG22) twisted pair	0.3mm ² (AWG22) shielded twisted pair	

Recommended Ferrule

Phoenix Contact Part No.	Order No.	Package Quantity
AI 0.25-8YE	3203037	100

Tools

Tool	Phoenix Contact Part No.	Order No.	Package Quantity
Crimping pliers	CRIMPFOX ZA3	1201882	1
Screwdriver	SZS 0.4×2.5	1205037	10

Order ferrule and tools to Phoenix Contact.

Mounting Hole Layout

Touch

Pro/Lite

FT1A-*12RA-*

FT1A-*12**

FT1A-*24**

FT1A-*40**/FT1A-*48**

FT1A-*14*A-*

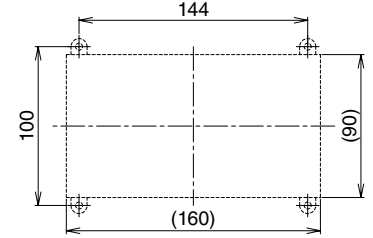
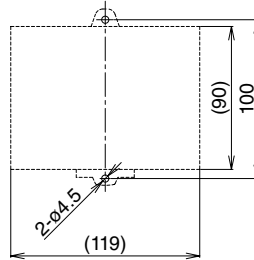
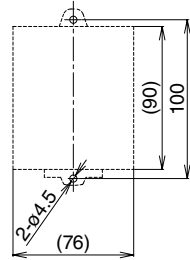
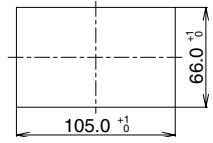

All dimensions in mm.

Dimensions

Touch (Display Model) / Relay Output Model (FT1A-12RA-*)

When using mounting bracket (HG9Z-4K2PN04)

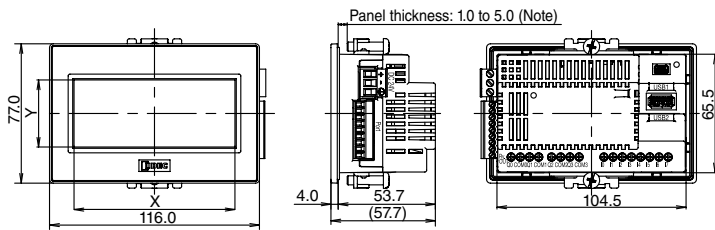

Note: Waterproof characteristic may not be obtained depending on the panel material and size.

LCD Active Area

LCD Type	X	Y
TFT	88.92	37.05
STN	87.59	35.49

When using rear mount adapter (FT9Z-1A01)

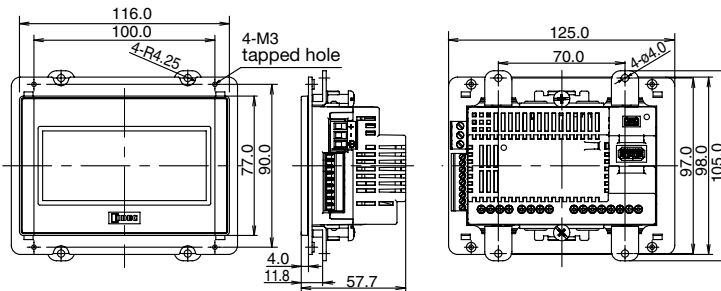

Touch (Display Model) / Transistor Output Model (FT1A-14KA-* / FT1A-14SA-*)

When using mounting bracket (HG9Z-4K2PN04)

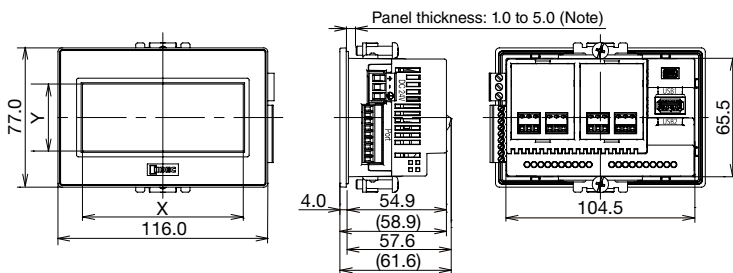

When using rear mount adapter (FT9Z-1A01)

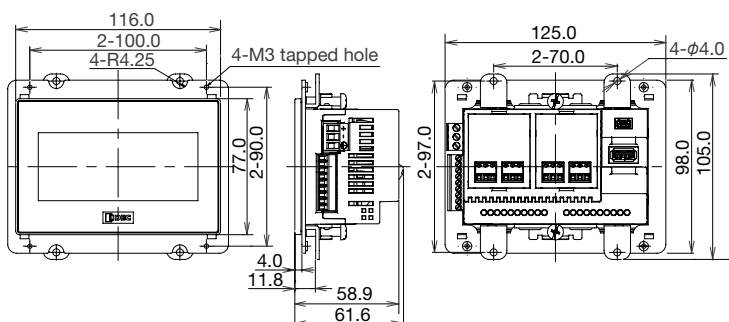

All dimensions in mm.

SmartAXIS Series FT1A Controller

Pro (LCD Model)

FT1A-H12*A/*C

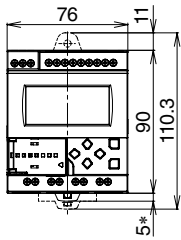

FT1A-H24*A/*C

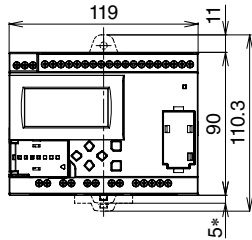

Lite (No LCD Model)

FT1A-B12*A/*C

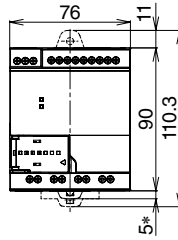

FT1A-B24*A/*C

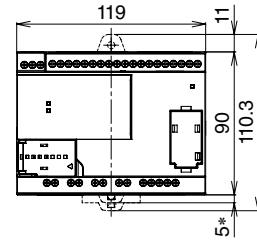

FT1A-H40*A/*C

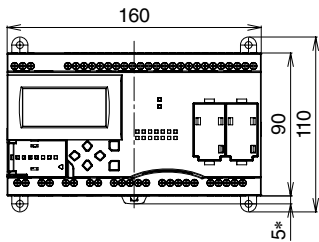

FT1A-H**A

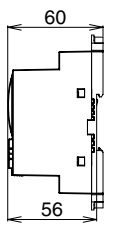

FT1A-H**C

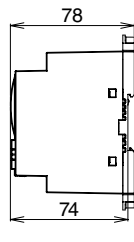

FT1A-B40*A/*C

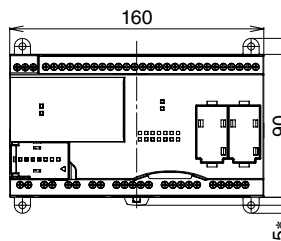

FT1A-B**A

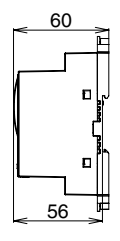

FT1A-B**C

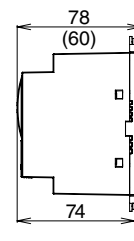

FT1A-H48*A/*C

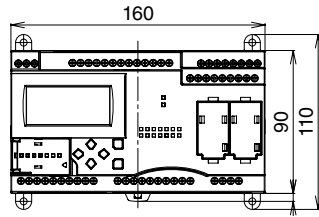

FT1A-H48*A/*C



FT1A-B48*A/*C

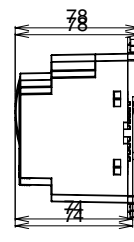
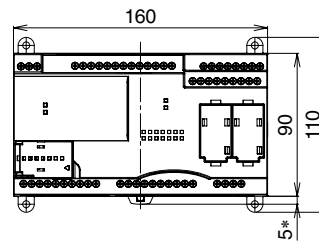

Note: 9.3 mm when the clamp is pulled out.

Note: 9.3 mm when the clamp is pulled out.

Terminal Arrangement and I/O Wiring Diagram Examples

Touch (Display Model)

FT1A-*12RA-*

For terminal arrangement and I/O wiring diagram, see User's Manual.

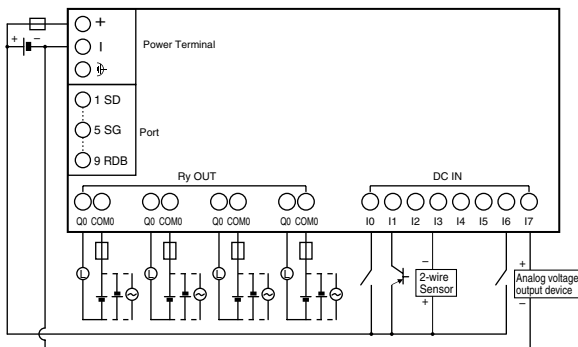

FT1A-*14KA-*

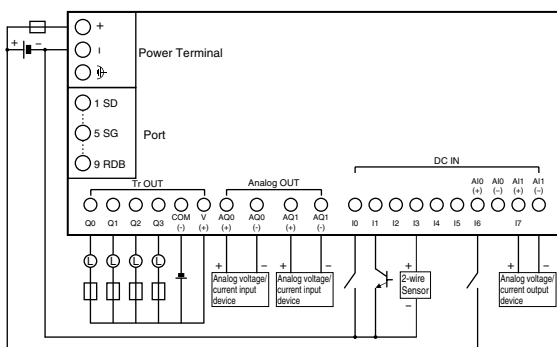

FT1A-*14SA-*

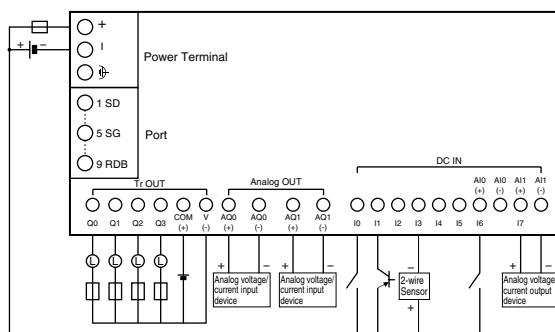

Pro/Lite (LCD/No LCD Models)

FT1A-*12RA

Input Side

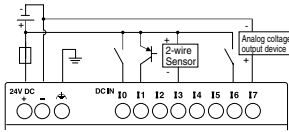

Output Side

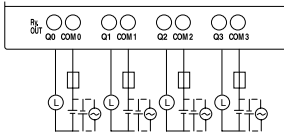

FT1A-*12RC

Input Side

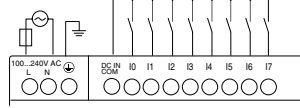

Output Side

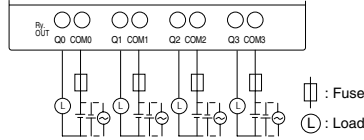

FT1A-*24RC (①)

Input Side (sink/source)

Source Input

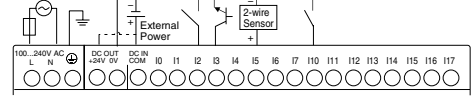

Sink Input

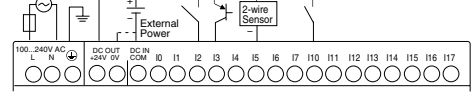

Output Side

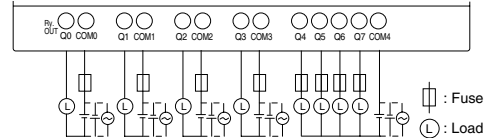

FT1A-*48SA (②)

Input Side

Sink Input

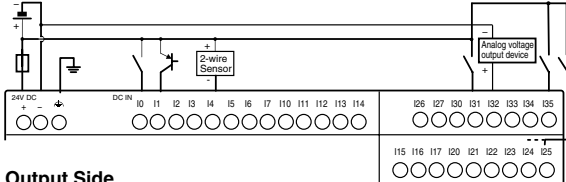

Output Side

Source Output

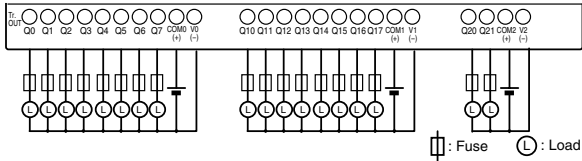

FT1A-*48KA (③)

Input Side

Source Input (Analog/Digital Shared Input is Sink Input)

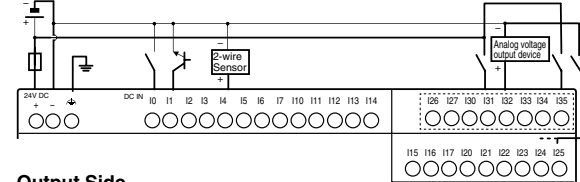

Output Side

Sink Output

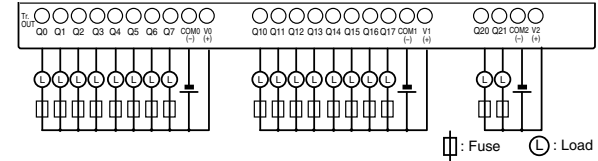

See ① for FT1A-*40RC, ① and ② for FT1A-*40RSA, and ① and ③ for FT1A-*40RKA.

Recommended Ferrules for Touch/Pro/Lite Terminals

For 1-wire connection

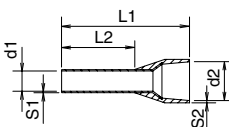

For 2-wire connection

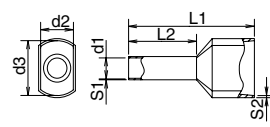

Dimensions in mm.

	Cross Section (mm ²)	AWG	Phoenix Contact Part No.	Touch				Pro/Lite		L1	L2	d1	S1	d2	d3	S2
				Power Supply	Serial Interface	I/O		Power Supply	I/O							
						Relay Output Model	Transistor Output Model									
1-wire connection	0.25	24	AI0.25-8YE					×	12.5	8.0	0.8	0.15	1.8		0.25	
	0.34	22	AI0.34-8TQ	×	×	×	×		12.5	8.0	0.8	0.15	2.0		0.25	
	0.5	20	AI0.5-8WH	×	×	×	×	—	14.0	8.0	1.1	0.15	2.5		0.25	
	0.75	18	AI0.75-8GY	×		×			14.0	8.0	1.3	0.15	2.8		0.25	
	1.0		AI1-8RD	×		—		×	14.0	8.0	1.5	0.15	3.0		0.3	
			AI1-10RD	—		×	—		—	16.0	10.0	1.5	0.15	3.0		0.3
		1.5	16	AI1.5-8BK	×		—		×	14.0	8.0	1.8	0.15	3.4		0.3
			AI1.5-10BK	—		×		—	18.0	10.0	1.8	0.15	3.4		0.3	
2-wire connection	0.5	20	AI-TWIN2x0.5-8WH	×	×	—	×	—	15.0	8.0	1.5	0.15	2.5	4.6	0.25	
	0.75	18	AI-TWIN2x0.75-8GY	×		—	—	×	15.0	8.0	1.8	0.15	2.8	5.2	0.25	
			AI-TWIN2x0.75-10GY	—		×	—	—	—	17.0	10.0	1.8	0.15	2.8	5.2	0.25
Screwdriver			SZS 0.6x3.5	×	—	×	—	×								
			SZS 0.4x2.5	—	×	—	×	—								

Note: Crimping pliers - Phoenix Contact part number CRIMPFOX ZA3 (12101882)

Instructions

Basic Instructions (Touch/Pro/Lite)

Instructions	Function
LOD	Stores intermediate results and reads contact status
LODN	Stores intermediate results and reads inverted contact status
AND	Series connection of NO contact
ANDN	Series connection of NC contact
OR	Parallel connection of NO contact
ORN	Parallel connection of NC contact
ANDL0D	Series connection of circuit blocks
ORL0D	Parallel connection of circuit blocks
BPS	Saves the result of bit logical operation temporarily
BRD	Reads the result of bit logical operation which was saved temporarily
BPP	Restores the result of bit logical operation which was saved temporarily
OUT	Outputs the result of bit logical operation
OUTN	Output the inverted result of bit logical operation
SET	Sets output, internal relay, or shift register bit
RST	Resets output, internal relay, or shift register bit
TMS	Subtracting 1-ms on-delay timer (0 to 65.535 sec)
TMH	Subtracting 10-ms on-delay timer (0 to 655.35 sec)
TIM	Subtracting 100-ms on-delay timer (0 to 6553.5 sec)
TML	Subtracting 1-sec on-delay timer (0 to 65535 sec)
TMSO	Subtracting 1-ms off-delay timer (0 to 65.535 sec)
TMHO	Subtracting 10-ms off-delay timer (0 to 655.35 sec)
TIMO	Subtracting 100-ms off-delay timer (0 to 6553.5 sec)
TMLO	Subtracting 1-sec off-delay timer (0 to 65535 sec)
CNT	Adding counter (0 to 65,535)
CNTD	Double-word adding counter (0 to 4,294,967,295)
CDP	Dual pulse reversible counter (0 to 65,535)
CDPD	Double-word dual pulse reversible counter (0 to 4,294,967,295)
CUD	Up/down selection reversible counter (0 to 65,535)
CUDD	Double-word up/down selection reversible counter (0 to 4,294,967,295)
CC=	Equal to comparison of counter current value
CC≥	Greater than or equal to comparison of counter current value
DC=	Equal to comparison of data register value
DC≥	Greater than or equal to comparison of data register value
SFR	Forward shift register
SFRN	Reverse shift register
SOTU	Rising-edge differentiation output
SOTD	Falling-edge differentiation output
JMP	Jumps a designated program area
JEND	Ends a jump instruction
MCS	Starts a master control
MCR	Ends a master control
END	Ends a program

Advanced Instructions (Touch/Pro/Lite)

Instructions	Name
NOP	No Operation
MOV	Move
MOVN	Move Not
IMOV	Indirect Move
IMOVN	Indirect Move Not
IBMV	Indirect Bit Move
IBMVN	Indirect Bit Move Not
BMOV	Block Move
NSET	N Data Set
NRS	N Data Repeat Set
XCHG	Exchange
TCCST	Timer/Counter Current Value Store
CMP=	Compare Equal To
CMP<>	Compare Unequal To
CMP<	Compare Less Than
CMP>	Compare Greater Than
CMP<=	Compare Less Than or Equal To
CMP>=	Compare Greater Than or Equal To
ICMP>=	Interval Compare Greater Than or Equal to
LC=	Load Compare Equal To
LC<>	Load Compare Unequal To
LC<	Load Compare Less Than
LC>	Load Compare Greater Than
LC<=	Load Compare Less Than or Equal To
LC>=	Load Compare Greater Than or Equal To
ADD	Addition
SUB	Subtraction
MUL	Multiplication
DIV	Division
INC	Increment
ADD	Addition
SUB	Subtraction
MUL	Multiplication
DIV	Division
INC	Increment
DEC	Decrement
ROOT	Root
SUM	Sum
RAD	Degree to Radian
DEG	Radian to Degree
SIN	Sine
COS	Cosine
TAN	Tangent
ASIN	Arc Sine
ACOS	Arc Cosine
ATAN	Arc Tangent
LOGE	Natural Logarithm
LOG10	Common Logarithm
EXP	Exponent
POW	Power
ANDW	AND Word
ORW	OR Word
XORW	Exclusive OR Word
SFTL	Shift Left
SFTR	Shift Right
BCDLS	BCD Left Shift
WSFT	Word Shift
ROTL	Rotate Left
ROTR	Rotate Right

Advanced Instructions (Touch/Pro/Lite continued)

Instructions	Name
HTOB	Hex to BCD
BTOH	BCD to Hex
HTOA	Hex to ASCII
ATOH	ASCII to Hex
BTOA	BCD to ASCII
ATOB	ASCII to BCD
ENCO	Encode
DECO	Decode
BCNT	Bit Count
ALT	Alternate Output
CVDT	Convert Data Type
DTDV	Data Divide
DTCB	Data Combine
SWAP	Data Swap
TXDn (Note 1)	Transmit
RXDn (Note 1)	Receive
ETXDn (Note 1)	Transmit over Ethernet
ERXDn (Note 1)	Receive over Ethernet
LABEL	Label
LJMP	Label Jump
LCAL	Label Call
LRET	Label Return
DJNZ	Decrement Jump Non-zero
MSG (Note 2)	Message
IOREF	I/O Refresh
HSCRf (Note 3)	High-speed Counter Refresh
WEEK	Week Timer
YEAR	Yearly Timer
TADD	Time Addition
TSUB	Time Subtraction
HOUR	Hour Meter
HTOS	HMS to Sec
STOH	Sec to HMS
DTML	1-sec Dual Timer
DTIM	100-ms Dual Timer
DTMH	10-ms Dual Timer
DTMS	1-ms Dual Timer
TTIM	Teaching Timer
PULSn (Note 4)	Pulse Output
PWMn (Note 4)	Pulse Width Modulation
RAMPn (Note 4)	Ramp Pulse Output
ZRNn (Note 4)	Zero Return
ARAMPn (Note 4)	Advanced Ramp
DI	Disable Interrupt
EI	Enable Interrupt
XYFS	XY Format Set
CVXTY	Convert X to Y
CVYTX	Convert Y to X
PID (Note 5)	Perform PID control
AVRG	Average
FIFO	FIFO Format
FIEX	First-In Execute
FOEX	First-Out Execute
NDSRC	N Data Search
SCRPT	Script
DLOG (Note 6)	Data Logging
TRACE (Note 6)	Data Trace

Note 1: Pro/Lite 24-I/O, 40-I/O, 48-I/O type only

Note 2: Pro only







Note 3: Touch, Pro/Lite DC power type only



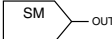
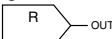
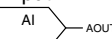
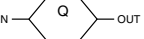
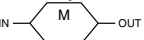
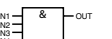
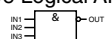
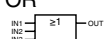
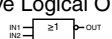
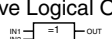

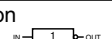
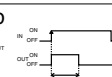
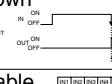
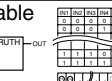

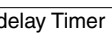
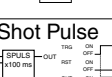
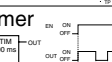

Note 4: Pro/Lite 40-I/O DC type and 48-I/O AC/DC type only

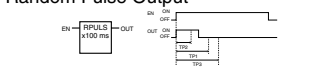
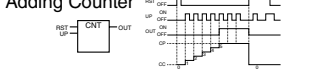
Note 5: Touch transistor output model only (FT1A-*14SA / FT1A-*14KA)

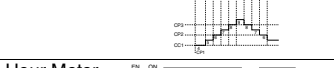
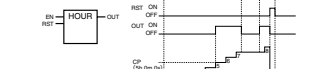
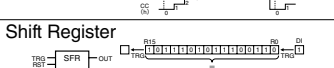
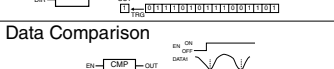
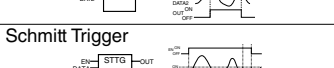
Note 6: Pro/Lite 40-I/O, 48-I/O only

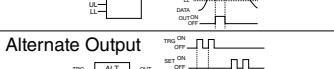
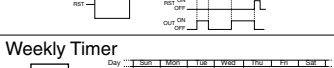
Function Blocks

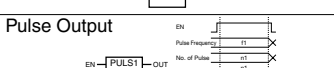
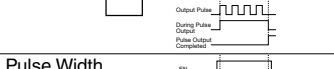
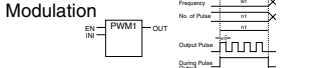
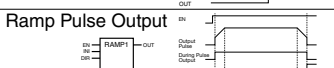
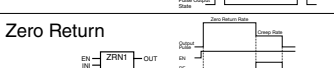
Type	Symbol	Name and Diagram	Function
Input	I	Digital Input 	Inputs ON/OFF information from an external to the SmartAXIS.
	SM	Special Internal Relay 	Special internal relays can be used as bit inputs for FBs in the SmartAXIS. Special function is allocated to each special internal relay.
	R	Shift Register 	Outputs ON/OFF state of a shift register device.
	AI	Analog Input 	The analog input values (0 to 10V DC) for the analog input terminals are converted to digital values (0 to 1,000) and output. With the analog input linear conversion function, the analog input value can be linearly conversion within a range of -32,768 to 32,767.
Output	Q	Digital Output 	Outputs ON/OFF information from the SmartAXIS to an external device.
	M	Internal Relay 	A bit unit FB used internally by the SmartAXIS.
Logical Operation	AND	Logical AND 	Implements logical AND for a maximum of four input signals (ON/OFF) and outputs the result.
	NAND	Negative Logical AND 	Implements negative logical AND for a maximum of four input signals (ON/OFF) and outputs the result.
	OR	Logical OR 	Implements logical OR for a maximum of four input signals (ON/ OFF) and outputs the result.
	NOR	Negative Logical OR 	Implements negative logical OR for a maximum of four input signals (ON/OFF) and outputs the result.
	XOR	Exclusive Logical OR 	Implements exclusive logical OR for a maximum of two input signals (ON/OFF) and outputs the result.
	NXOR	Negative Exclusive Logical OR 	Implements negative exclusive logical OR for a maximum of two input signals (ON/ OFF) and outputs the result.
	NOT	Negation 	Outputs the result of negating the input signal (ON/OFF).
	SOTU	Shot up 	Turns on the output for one scan when the input signal turns from off to on.
	SOTD	Shot down 	Turns on the output for one scan when the input signal turns from on to off.
	TRUTH	Truth Table 	A truth table for the output can be configured corresponding to the 16 patterns combination of the four input signals, and TRUTH FB outputs the result according to the table.
Timer	TIMU	On-delay Count Up Timer 	After the execution input turns on, the output turns on when the on-delay time elapses. The current value is incremented from zero to the preset value.
	TIMD	On-delay Count Down Timer 	After the execution input turns on, the output turns on when the on-delay time elapses. The current value is decremented from the preset value to zero.
	TIMOU	Off-delay Count Up Timer 	When the execution input turns on, the output turns on. After the execution input turns off, the output turns off when the off-delay time elapses. The current value is incremented from zero to the preset value.
	TIMOD	Off-delay Count Down Timer 	When the execution input turns on, the output turns on. After the execution input turns off, the output turns off when the off-delay time elapses. The current value is decremented from the preset values to zero.
	TIMCU	On/off-delay Timer 	After the execution input turns on, the output turns on when the on-delay time elapses. After the execution input turns off, the output turns off when the off-delay time elapses.
	SPULS	Single Shot Pulse 	After the execution input turns on, the output turns on for the configured time period.
	DTIM	Dual Timer 	The output is turned on and off according to the configured ON and OFF time.

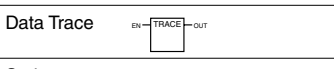
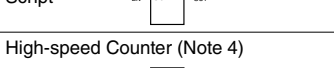
Timer	RPULS	 <p>Random Pulse Output</p>	The output is turned on for the length of random time within the configured range of time.
Counter	CNT	 <p>Adding Counter</p>	When the clock input is turned on, the current value is incremented by one. The output turns on when the current value reaches the preset value.
	CUD	 <p>Up/Down Selection Reversible Counter</p>	When the clock input is turned on, the current value is incremented or decremented by one according to the up/down selection input. The current value is compared with ON/OFF thresholds. The output turns on or off according to the comparison result.
	HOUR	 <p>Hour Meter</p>	Accumulates the ON duration of the execution input in hours, minutes, and seconds. The output turns on when the accumulated time reaches the configured time.
Shift Register	SFR	 <p>Shift Register</p>	When the execution input turns on, the shift registers are shifted to the specified shift direction.
Data Comparison	CMP	 <p>Data Comparison</p>	Two inputs values are compared and the output turns on or off according to the comparison result.
	STTG	 <p>Schmitt Trigger</p>	The comparison input value and the ON/OFF thresholds are compared and the output turns on or off according to the comparison result.
	RCMP	 <p>Range Comparison</p>	The comparison input value and the upper/lower limits are compared and the output turns on or off according to the comparison result.
Data Conversion	ALT	 <p>Alternate Output</p>	Sets/resets the output.
Week Programmer	WEEK	 <p>Weekly Timer</p>	Compares the specified day of the week, ON time, and OFF time with the current time and outputs the result.
	YEAR	 <p>Yearly Timer</p>	Compares the specified date with the current date and outputs the result.
Interface (Note 1)	MSG	 <p>Message</p>	Displays data such as text and device values on the LCD on the SmartAXIS Pro.
Pulse (Note 2)	PULS	 <p>Pulse Output</p>	Outputs pulses at the specified frequency.
	PWM	 <p>Pulse Width Modulation</p>	Outputs pulses at the specified frequency and duty cycle.
	RAMP	 <p>Ramp Pulse Output</p>	Outputs pulses with the frequency change function.
	ZRN	 <p>Zero Return</p>	Outputs pulses with the different pulse frequency corresponding to the on/off state of a deceleration signal.
	ARAMP	 <p>Advanced Ramp</p>	Output pulses with the frequency change function according to the settings configured in the frequency table.
Data Logging (Note 3)	DLOG	 <p>Data Log</p>	Saves the values of the specified devices in the specified data format as a CSV file to the SD memory card.
	TRACE	 <p>Data Trace</p>	Saves the values of the previous number of scans for the specified device in the specified data format as a CSV file to the SD memory card.
Script	SCRPT	 <p>Script</p>	Enables you to program complicated processing with the script language that supports conditional branching, logical operations, arithmetic operations, and functions.
Special	HSC	 <p>High-speed Counter (Note 4)</p>	Operates the high-speed counter configured in the function area settings. Turns on/off the high-speed counter gate input/reset input/clear input.
	RSFF	 <p>RS Flip-flop</p>	When the set input turns on, the output turns on and keeps on. When the reset input turns on, the output turns off.

Note 1: Pro only

Note 3: Pro/Lite 40-I/O, 48-I/O only

Note 2: Pro/Lite 40-I/O DC type and 48-I/O AC/DC type only

Note 4: Touch, Pro/Lite DC power type only

Scripts

Type	Format	Description
Control statements	if	if ((Cond. expr.)) (Exe. line);
	if else	if ((Cond. expr.)) (Exe. line1); else(Exe. line2);
	if else if else	if ((Cond. expr1.)) (Exe. line1); else if ((Cond. expr2.))(Exe. line2); else(Exe. line3);
	switch case default	switch (Cond. expr.) {case constant 1: (Cond. expr1.);break; case constant2: (Cond. expr2.); break; default: (Cond. expr3.);break;}
	while	while ((Cond. expr.))(Exe. line);
	break	break;
	return	return;
Relational operator	==, !=, <, >, <=, >=	Two values are compared.
Logical operator	&&, , !	Logical operation of two values (AND, OR, NOT).
Arithmetic operator	+, -, *, /, %, =	Addition, subtraction, multiplication, division, remainder, assignment
Bit operator	&, , ^, ~, <<, >>	Logical product (AND), logical sum (OR), exclusive logical sum (XOR), reverse, shift left, shift right
Bit function	Bit set	SET (a);
	Bit reset	RST (a);
	Bit reverse	REV (a);
Arithmetic operation	Maximum value	MAX(a, b, c)
	Minimum value	MIN (a, b, c)
	Exponential function	EXP (a)
	Natural logarithm	LOGE (a)
	Common logarithm	LOG10 (a)
	Exponentiation	POW (a, b)
	Square root	ROOT (a)
	Sine	SIN (a)
	Cosine	COS (a)
	Tangent	TAN (a)
	Arcsine	ASIN (a)
	Arccosine	ACOS (a)
	Arctangent	ATAN (a);
	Conversion from angle to radian	RAD (a);
Conversion from radian to angle	DEG (a);	
Data type conversion	Conversion from BCD to Binary	BCD2BIN (a)
	Conversion from binary to BCD	BIN2BCD (a)
	Conversion from float32 to binary	FLOAT2BIN (a)
	Conversion from binary to float32	BIN2FLOAT (a)
	Conversion from decimal to string character	DEC2ASCII (a, b)
	Conversion from string character to decimal	ASCII2DEC (a)
	Data comparison	MEMCMP (a, b, c)
	Data copy	MEMCPY (a, b, c)
	Character string copy	STRCUT (a, b, c, d)
	Character number count	STRLEN (a)
Character string operation	Character string concatenation	STRCAT (a, b)
	Character string search	STRSTR (a, b)
	Drawing of straight line	LINE (a, b, c, d)
	Drawing of rectangle	RECTANGLE (a, b, c, d)
Draw (Note 1)	Drawing of circle and ellipse	CIRCLE (a, b, c, d)
	Offset	OFFSET (a, b)
Bit device ↔ word device Cross Operator Functions (Note 2)	Bit device (1 word length) to bit device (1 word length)	BITS2BITS (a, b)
	Bit device (1 word length) to Word device	BITS2WORD (a, b)
	Word device to bit device (1 word length)	WORD2BITS (a, b)

Note 1: Touch (WindO/I-NV3) only Note 2: Pro/Lite (WindLDR)

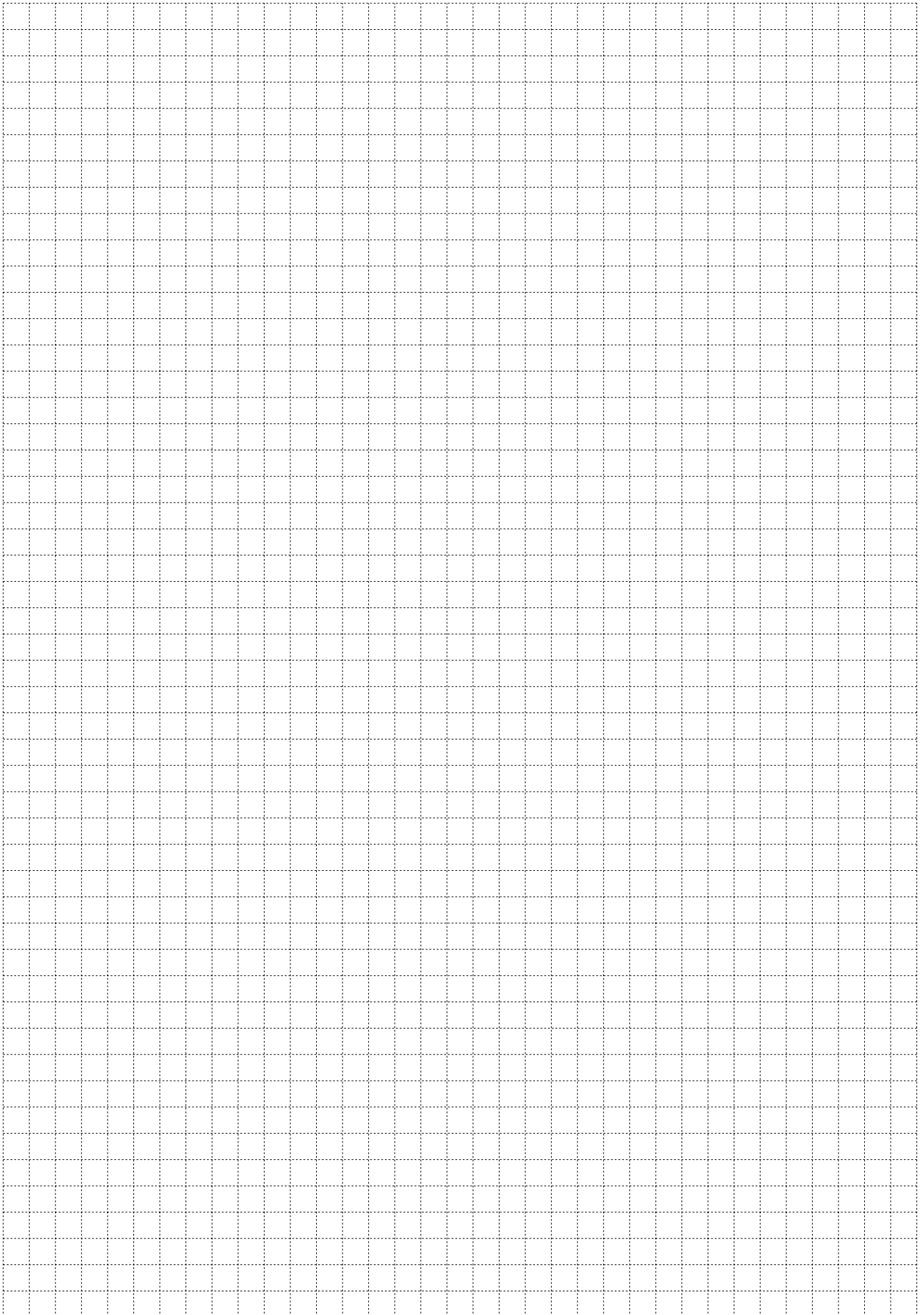

HG Series Operator Interface

SmartAXIS Pro/Lite can be connected to IDEC's HG series operator interface for powerful expressivity and rich information!



- Excellent visibility achieved by super-bright LED backlight. 600 cd/m² (8.4-inch), 700 cd/m² (10.4-inch), 550 cd/m² (12.1-inch), 800 cd/m² (5.7-inch)
- High-resolution SVGA (800 × 600 pixels) and 65,536 colors provides high-quality display.
- More than 7,000 graphic images available in the image library.
- A maximum of four expansion MicroSmart I/O modules can be mounted.
- Multimedia models with video and audio record and play back high quality images.
- Fast-speed 400 MHz CPU and unique software technology shorten startup time.
- IP66 (front part when mounted) (IEC 60529)

Switching Power Supplies

PS5R-S

- Slim size DIN rail mount switching power supplies with finger-safe terminals
- Universal input. Wide power range: 10W, 15W, 30W, 60W, 90W, 120W, and 240W.
- DIN rail mounting. Optional mounting bracket is available for panel surface mount.
- IP20 (IEC 60529)



PS6R

- High-power and space-saving.
- 93% efficiency reduces running costs.
- Input voltage: 100 to 240V AC (voltage range: 85 to 264V AC/110 to 350V DC)
- The terminals are captive spring-up screws. Ring or fork terminals can be used.
- Finger-safe construction prevents electric shocks.
- Panel mounting bracket and side-mounting panel mounting bracket. Can be attached to a DIN rail or directly to a panel surface.
- IP20 (IEC 60529)



Specifications and other descriptions in this brochure are subject to change without notice.



IDEC CORPORATION

6-64, Nishi-Miyahara 2-Chome, Yodogawa-ku, Osaka 532-0004, Japan
Tel: +81-6-6398-2527, Fax: +81-6-6398-2547
E-mail: marketing@idec.co.jp

IDEC CORPORATION (USA)
1175 Elko Drive, Sunnyvale, CA 94089-2209, USA
Tel: +1-408-747-0550 / (800) 262-IDEAC (4332)
Fax: +1-408-744-9055 / (800) 635-6246
E-mail: opencontact@idec.com

IDEC CANADA LIMITED
3155 Pepper Mill Court, Unit 4
Mississauga, Ontario, L5L 4X7, Canada
Tel: +1-905-890-8561, Toll Free: (800) 262-IDEAC (4332)
Fax: +1-905-890-8562
E-mail: sales@ca.idec.com

IDEC AUSTRALIA PTY. LTD.
Unit 17, 104 Ferntree Gully Road,
Oakleigh, Victoria 3166, Australia
Tel: +61-3-8523-5900, Toll Free: 1800-68-4332
Fax: +61-3-8523-5999
E-mail: sales@au.idec.com

IDEC ELECTRONICS LIMITED
Unit 2, Beechwood, Chineham Business Park,
Basingstoke, Hampshire RG24 8WA, UK
Tel: +44-1256-321000, Fax: +44-1256-327755
E-mail: sales@uk.idec.com

IDEC ELEKTROTECHNIK GmbH
Wendenstrasse 331, 20537 Hamburg, Germany
Tel: +49-40-25 30 54 - 0, Fax: +49-40-25 30 54 - 24
E-mail: service@idec.de

IDEC (SHANGHAI) CORPORATION
Room 701-702 Chong Hing Finance Center,
No. 288 Nanjing Road West, Shanghai 200003, PRC
Tel: +86-21-6135-1515
Fax: +86-21-6135-6225 / +86-21-6135-6226
E-mail: idec@cn.idec.com

IDEC (BEIJING) CORPORATION
Room 211B, Tower B, The Grand Pacific Building,
8A Guanghua Road, Chaoyang District,
Beijing 100026, PRC
Tel: +86-10-6581-6131, Fax: +86-10-6581-5119

IDEC (SHENZHEN) CORPORATION
Unit AB-3B2, Tian Xiang Building, Tian'an Cyber Park,
Fu Tian District, Shenzhen, Guang Dong 518040, PRC
Tel: +86-755-8356-2977, Fax: +86-755-8356-2944

IDEC IZUMI (H.K.) CO., LTD.
Unit G & H, 26/F., MG Tower,
No. 133 Hoi Bun Road, Kwun Tong, Kowloon,
Hong Kong
Tel: +852-2803-8989, Fax: +852-2565-0171
E-mail: info@hk.idec.com

IDEC TAIWAN CORPORATION
8F-1, No. 79, Hsin Tai Wu Road, Sec. 1,
Hsi-Chih District, 22101 New Taipei City, Taiwan
Tel: +886-2-2698-3929, Fax: +886-2-2698-3931
E-mail: service@tw.idec.com

IDEC IZUMI ASIA PTE. LTD.
No. 31, Tannery Lane #05-01,
HB Centre 2, Singapore 347788
Tel: +65-6746-1155, Fax: +65-6844-5995
E-mail: info@sg.idec.com

IDEC ASIA (THAILAND) CO., LTD.
20th Fl., Sorachai Bldg., No.23/78,
Soi Sukhumvit 63, Sukhumvit Rd.,
Klongton-nua, Wattana, Bangkok 10110
Tel: +662-392-9765, Fax: +662-392-9768
E-mail: sales@th.idec.com