



Position switch with safety function

ES 14 R 1Ö/1S - 5m

Číslo materiálu: 1045374 (Staré číslo materiálu: 14009913)

Vlastnosti/možnosti

- Thermoplastic enclosure
- Double insulated
- Slow action , change-over contact with double break
- Mounting details to EN 50047
- Suitable for in-line mounting

- With pre-wired cable, cable length 5 m
- Actuator: Roller plunger R
- Actuating speed max. 0.5 m/s with a vertical actuating angle of 30°
- Metal roller

Note

- Actuator can be repositioned by 90° on request

Rozměry

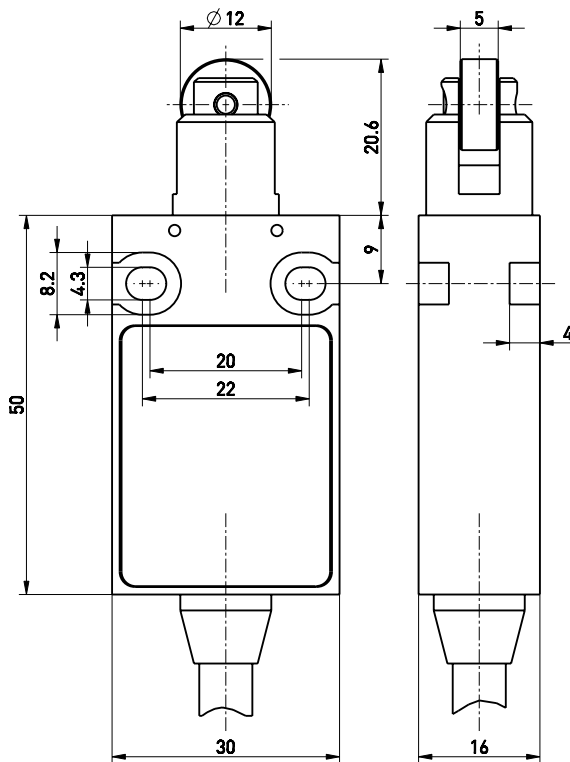

Technická data

Standards	EN ISO 13849-1; EN 60947-5-1
Enclosure	glass-fibre reinforced, shock-proof thermoplastic, self-extinguishing UL 94-V0 IP 67 to IEC/EN 60529
Degree of protection	IP 67 to IEC/EN 60529
Contact material	silver
Switching system	slow action, positive break
Switching elements	NC contacts change-over contact with double break, galvanically separated contact bridges
Connection	pre-wired cable H05VV-F
Cable cross-section	4 x 0.75 mm ²
B _{10d} (10 % Load)	2 million
T _M	max. 20 years
U _{imp}	4 kV
U _i	250 V
I _{the}	6 A
I _e /U _e	6 A/250 VAC; 0.25 A/230 VDC
Utilisation category	AC-15; DC-13
Max. fuse rating	6 A gG/gN fuse
Ambient temperature	-20 °C ... +75 °C
Mechanical life	> 1 million operations
Frequency of operation	1800/h
Repeat accuracy of switching points	± 0.1 mm
Contact gap	max. 2 x 4 mm
Approvals	
Weight	430 g

Omyly a technické změny vyhrazeny.

Contact diagram

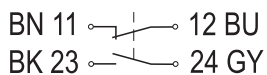

Switching diagram

